



Low Quiescent Current Voltage Regulator

Features

- Low current consumption (typically 4.5μA)
- Output voltage accuracy ±2.5%
- Drop-output voltage (typically)
 - 2.5V @ 50mA loading
 - 1.6V @10mA loading
- Wide operating range (max 25V)
- Internal over temperature protection
- Excellent line regulation
 - Regulation <5mV @1mA loading VCC 6~25V
- Good load regulation
 - Regulation: (typically)
 - 40mV @V_{CC} 7V loading 1μA to 30mA
- SOT-89 and SOT-23-5 package available

General Description

The G920 is a three terminal positive voltage regulator made using the CMOS process. The G920 can work in a wide operation range from 6V to 25V. The quiescent current is small even at high input voltage. The typical current consumption is about 4.5μA. It is very suitable for the battery-powered portable equipment, especially the keep-alive system. The G920 can provide the higher performance and a longer battery service life.

Package Type

Typical Application

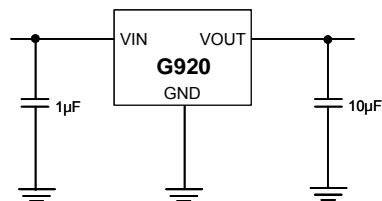
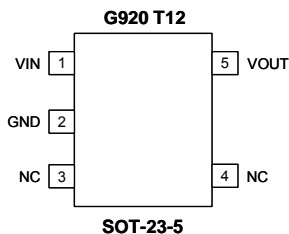
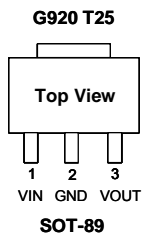
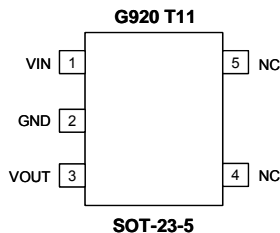
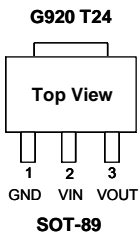



Ordering Information

ORDER NUMBER	ORDER NUMBER (Pb free)	MARKING	VOLTAGE	TEMP. RANGE	PACKAGE
---	G920AT11U	920Ax	3.3V	-40°C to 85°C	SOT-23-5
---	G920BT11U	920Bx	3.5V	-40°C to 85°C	SOT-23-5
---	G920CT11U	920Cx	5.0V	-40°C to 85°C	SOT-23-5
---	G920AT12U	920Dx	3.3V	-40°C to 85°C	SOT-23-5
---	G920BT12U	920Ex	3.5V	-40°C to 85°C	SOT-23-5
---	G920CT12U	920Fx	5.0V	-40°C to 85°C	SOT-23-5
G920AT24U	G920AT24Uf	920A4	3.3V	-40°C to 85°C	SOT-89
G920BT24U	G920BT24Uf	920B4	3.5V	-40°C to 85°C	SOT-89
G920CT24U	G920CT24Uf	920C4	5.0V	-40°C to 85°C	SOT-89
G920AT25U	G920AT25Uf	920A5	3.3V	-40°C to 85°C	SOT-89
G920BT25U	G920BT25Uf	920B5	3.5V	-40°C to 85°C	SOT-89
G920CT25U	G920CT25Uf	920C5	5.0V	-40°C to 85°C	SOT-89

Order Number Identification

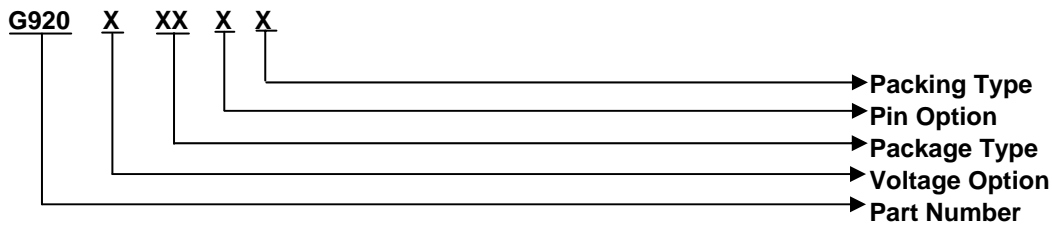

PACKAGE TYPE	VOLTAGE OPTION	SOT-89			PIN OPTION					PACKING
		1	2	3	1	2	3	4	5	
T1 : SOT-23-5	A : 3.3V				1 : VIN	GND	VOUT	NC	NC	U : Tape & Reel
T2 : SOT-89	B : 3.5V	1 : VOUT	GND	VIN	2 : VIN	GND	NC	NC	VOUT	
	C : 5.0V	2 : VOUT	VIN	GND						
		3 : GND	VOUT	VIN						
		4 : GND	VIN	VOUT						
		5 : VIN	GND	VOUT						
		6 : VIN	VOUT	GND						



Absolute Maximum Ratings ⁽¹⁾

Supply Voltage
 VIN to GND. -0.3V to +30V
 Operating Ambient Temperature Range
 TA -40°C to +125°C
 Maximum Junction Temperature, TJ 150°C
 Storage Temperature Range, TSTG -65°C to +150°C
 Reflow Temperature (soldering, 10 sec) 260°C
 Electrostatic Discharge, VESD
 Human body mode 2000V⁽²⁾
 Thermal Resistance Junction to Ambient, (θ_{JA})⁽³⁾
 SOT-89 162°C/W
 SOT-23-5 250°C/W

Recommend Operation Range

Operating Ambient Temperature Range
 TA -40°C to +85°C
 VIN to GND 6V to 25V

Note:

- ⁽¹⁾: Absolute maximum rating indicates limits beyond which damage to the device may occurs.
- ⁽²⁾: Human body model : C = 100pF, R = 1500Ω, 3 positive pulses plus 3 negative pulses
- ⁽³⁾: Mounted on Recommended Minimum Footprint , see P.6

Electrical Characteristics

VIN=7.0V, TA=25°C, unless otherwise noted.

PARAMETER	SYMBOL	CONDITION	MIN	TYP	MAX	UNIT
Input Voltage	VIN		6	---	25	V
Output Voltage	VOUT	Io=10mA	3.2175	3.3	3.3825	V
			3.4125	3.5	3.5875	V
			4.875	5.0	5.125	V
Current Consumption	IQ	Unload	---	4.5	8	μA
Dropoutput Voltage	VDROP	Io=10mA	---	1.6	1.8	V
Line Regulation1	ΔVLNR1	VIN=6V to 25V, Io=1mA, VO=3.3V/3.5V	---	5	30	mV
		VIN=7V to 25V, Io=1mA, VO=5V				
Line Regulation2	ΔVLNR2	VIN =6V to 25V, Io=1μA, VO=3.3V/3.5V	---	5	30	mV
		VIN =7V to 25V, Io=1μA, VO=5V				
Load Regulation	ΔVLDR	VIN =7V, Io=1μA to 30mA	---	40	90	mV
Temperature Drift	ΔVOUT/ΔTA	Io=10mA, TA=-40°C~85°C	---	± 0.5	---	mV/°C



Typical Performance Characteristics

V_{IN}=7V, T_A=25°C, unless otherwise noted.

Line Transient

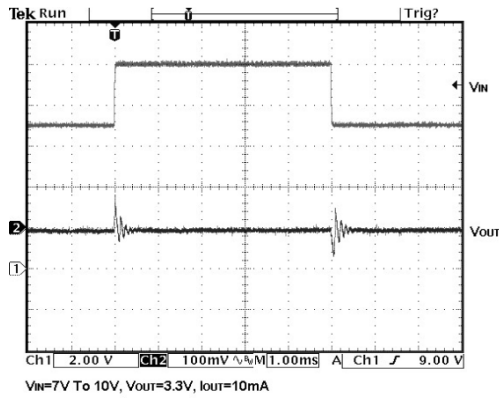

Load Transient

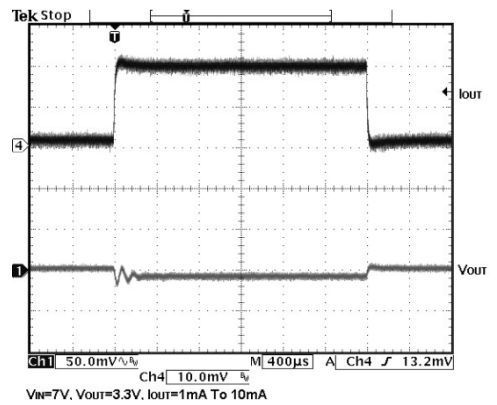

Quiescent Current vs. Input Voltage

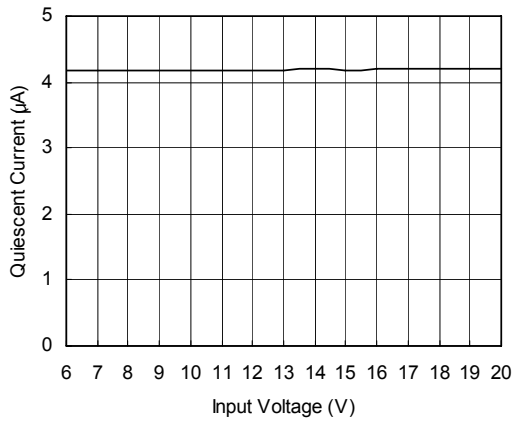

Quiescent Current vs. Temperature

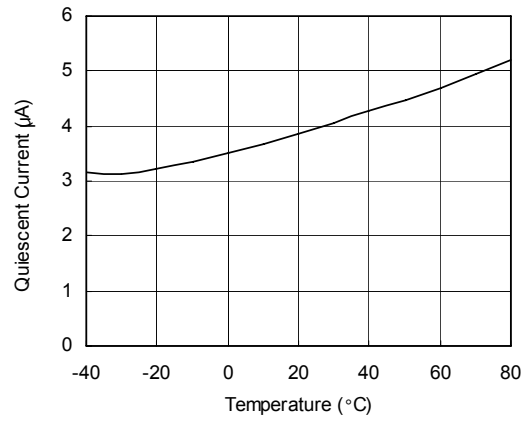

Output Voltage vs. Input Voltage

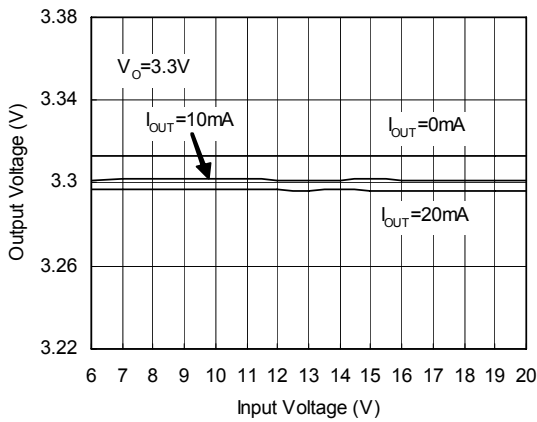

Output Voltage vs. Output Current

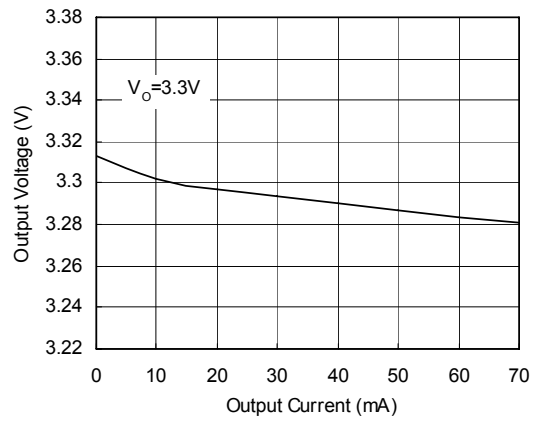



Typical Performance Characteristics (continued)

Dropout Voltage vs. Output Current

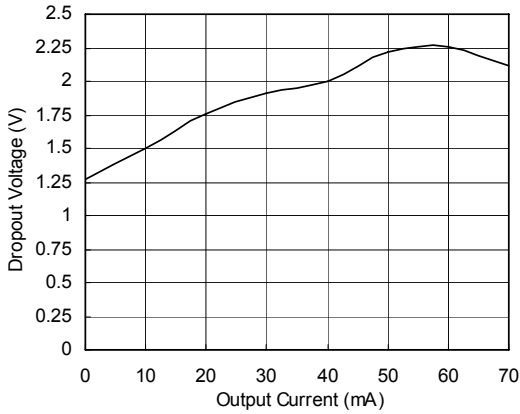

Dropout Voltage vs. Temperature

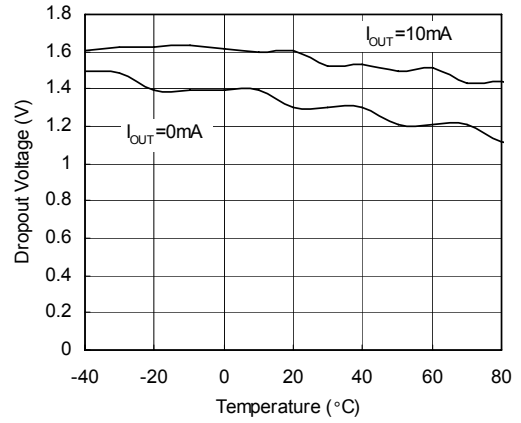

Output Voltage vs. Temperature

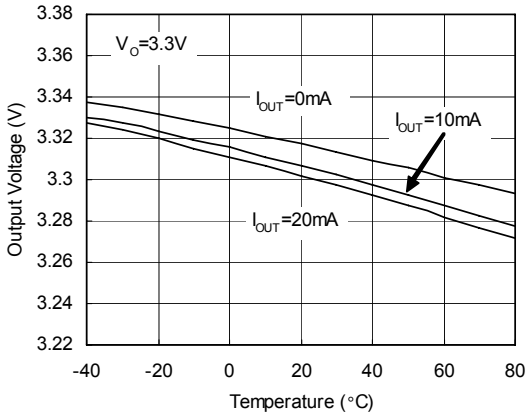

SOT-89 Max. Power Dissipation vs. PCB Top Copper Area

$T_{AMB} = 25^{\circ}C$; Still Air

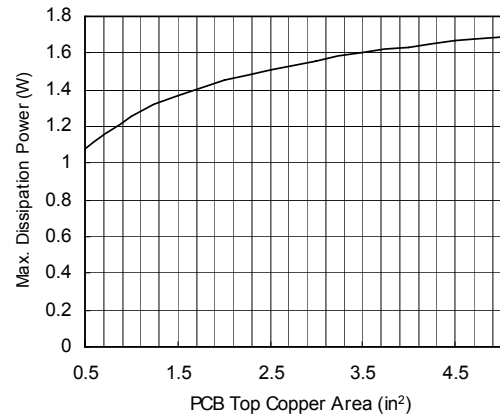

SOT-89 Max. Power Dissipation vs. T_{AMB} (still air) (Different PCB Top Copper Area)

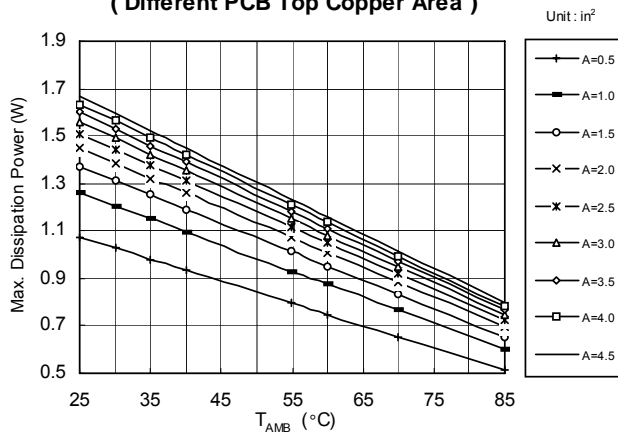

Recommended Minimum Footprint

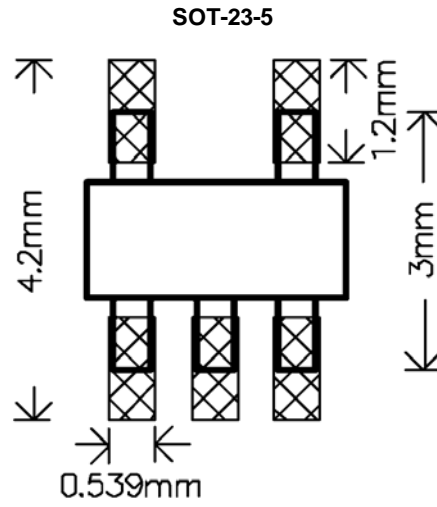
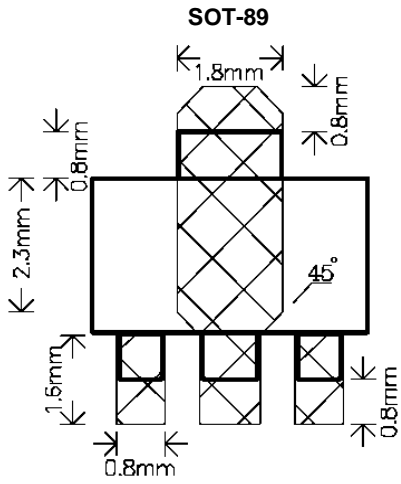

Package Information

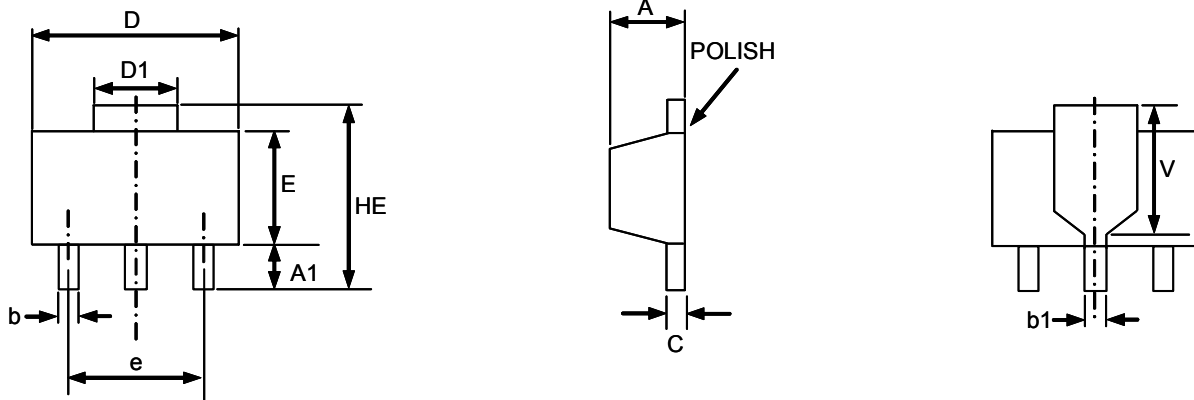

SOT-89 (T2) Package

SYMBOL	DIMENSIONS IN MILLIMETER			DIMENSIONS IN INCHE		
	MIN	NOM	MAX	MIN	NOM	MAX
A	1.40	1.50	1.60	0.055	0.059	0.063
A1	0.80	1.04	-----	0.031	0.041	-----
b	0.36	0.42	0.48	0.014	0.016	0.018
b1	0.41	0.47	0.53	0.016	0.018	0.020
C	0.38	0.40	0.43	0.014	0.015	0.017
D	4.40	4.50	4.60	0.173	0.177	0.181
D1	1.40	1.60	1.75	0.055	0.062	0.069
HE	-----	-----	4.25	-----	-----	0.167
E	2.40	2.50	2.60	0.094	0.098	0.102
e	2.90	3.00	3.10	0.114	0.118	0.122
V	-----	2.60	-----	-----	0.102	-----

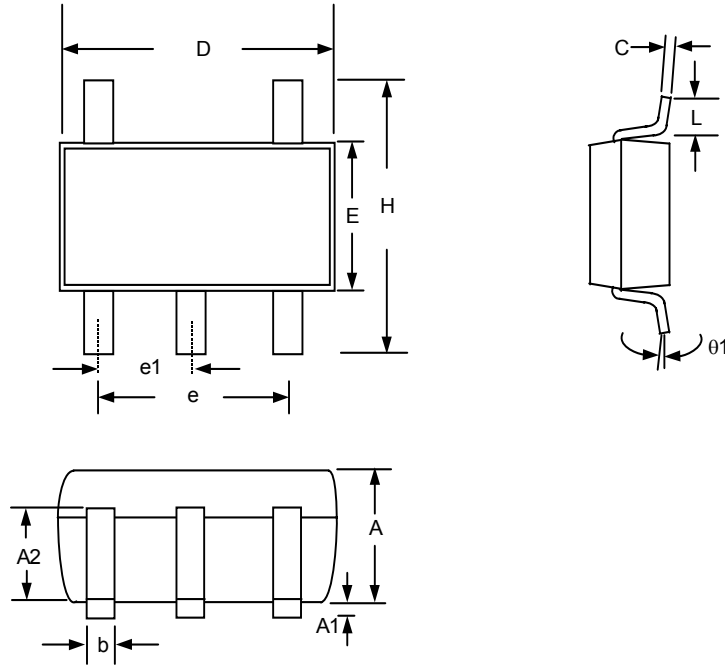

SOT-23-5 (T1) Package

Note:

1. Package body sizes exclude mold flash protrusions or gate burrs
2. Tolerance ± 0.1000 mm (4mil) unless otherwise specified
3. Coplanarity: 0.1000mm
4. Dimension L is measured in gage plane

SYMBOL	DIMENSION IN MM			DIMENSION IN INCH		
	MIN.	NOM.	MAX.	MIN.	NOM.	MAX.
A	1.00	1.10	1.30	0.039	0.043	0.051
A1	0.00	----	0.10	0.000	----	0.004
A2	0.70	0.80	0.90	0.028	0.031	0.035
b	0.35	0.40	0.50	0.014	0.016	0.020
C	0.10	0.15	0.25	0.004	0.006	0.010
D	2.70	2.90	3.10	0.106	0.114	0.122
E	1.40	1.60	1.80	0.055	0.063	0.071
e	----	1.90(TYP)	----	----	0.075(TYP)	----
H	2.60	2.80	3.00	0.102	0.110	0.118
L	0.37	----	----	0.015	----	----
$\theta 1$	1°	5°	9°	1°	5°	9°

Taping Specification

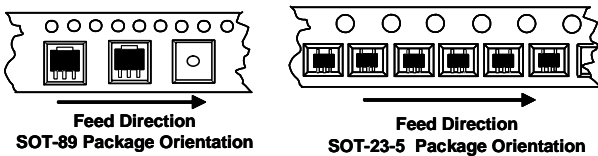

PACKAGE	Q'TY/REEL
SOT-89	1,000 ea
SOT-23-5	3,000 ea

GMT Inc. does not assume any responsibility for use of any circuitry described, no circuit patent licenses are implied and GMT Inc. reserves the right at any time without notice to change said circuitry and specifications.