

$$I_{F(AV)} = 0.2\text{Amp}$$

$$V_R = 30\text{V}$$

Major Ratings and Characteristics

Characteristics	Value	Units
I_F (DC)	0.2	A
V_{RRM}	30	V
I_{FSM} @ $t_p = 10\text{ms}$ sine	1.0	A
V_F @ 30mA DC, $T_J = 25^\circ\text{C}$	0.5	V
P_d Power Dissipation @ $T_A = 25^\circ\text{C}$	200	mW
T_J range	- 65 to 150	$^\circ\text{C}$

Description/ Features

This Schottky barrier diode is designed for high speed switching application, voltage clamping and circuit protection. Miniature surface mount packages with reduced foot print are excellent for portable application where space is limited

- Small foot print, surface mountable
- Very low forward voltage drop
- Extremely fast switching speed for high frequency operation
- Guard ring for enhanced ruggedness and long term reliability

Case Styles

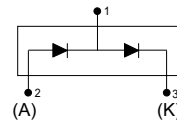
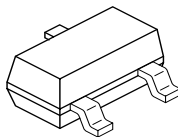

SOT23

Voltage Ratings

Part number	Value
V _R Max. DC Reverse Voltage (V)	30
V _{RWM} Max. Working Peak Reverse Voltage (V)	

Absolute Maximum Ratings

Parameters	Value	Units	Conditions
I _F Forward Current	0.2	A	DC, per Leg
I _{FSM} Max. Peak One Cycle Non-Repetitive Surge Current, @ T _J = 25°C	8.4	A	5µs Sine or 3µs Rect. pulse
	1.0	A	10ms Sine or 6ms Rect. pulse

Following any rated load condition and with rated V_{RWM} applied

Electrical Specifications

Parameters	Value	Units	Conditions
V _{FM} Max. Forward Voltage Drop (1)	0.24	V	@ 0.1mA
	0.32	V	@ 1mA
V _{FM} Max. Forward Voltage Drop (1)	0.40	V	@ 10mA
	0.50	V	@ 30mA
	0.65	V	@ 100mA
I _{RM} Max. Reverse Leakage Current	2	µA	V _R = 25V
	3	µA	V _R = 30V
C _T Max. Junction Capacitance	10	pF	V _R = 5V _{DC} (test signal range 100KHz to 1Mhz), T _J = 25°C
dv/dt Max. Voltage Rate of Change (Rated V _R)	10000	V/µs	

(1) Pulse Width < 300µs, Duty Cycle < 2%

Thermal-Mechanical Specifications

Parameters	Value	Units	Conditions
T _J Max. Junction Temperature Range(*)	-65 to 150	°C	
T _{stg} Max. Storage Temperature Range	-65 to 150	°C	
R _{th(j-a)} Max. Thermal Resistance Junction to Ambient	500	°C/W	Mounted on PC board FR4 with minimum pad size
Wt Approximate Weight	0.008	gr	
Case Style	SOT23		
Device Marking	HYWLC		

(*) $\frac{dP_{tot}}{dT_j} < \frac{1}{R_{th(j-a)}}$ thermal runaway condition for a diode on its own heatsink

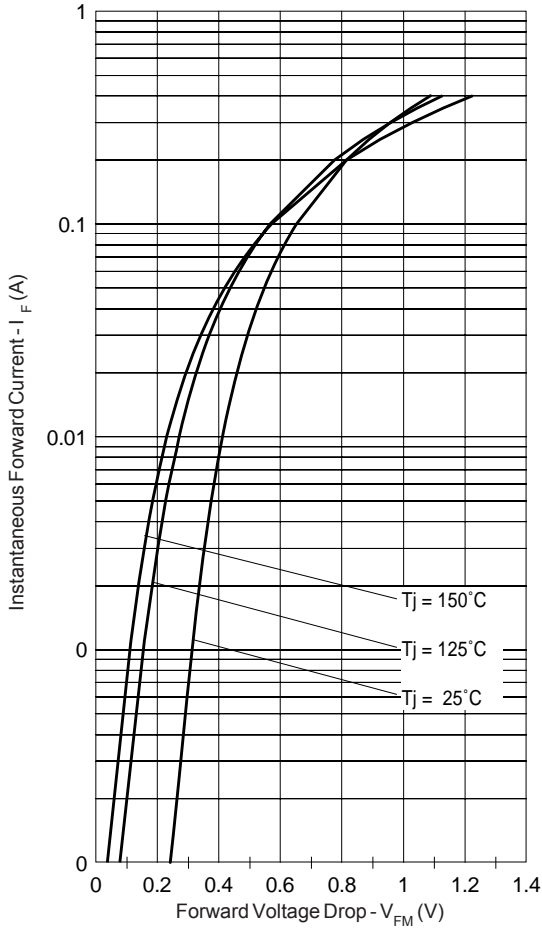

Fig. 1 - Max. Forward Voltage Drop Characteristics (Per Leg)

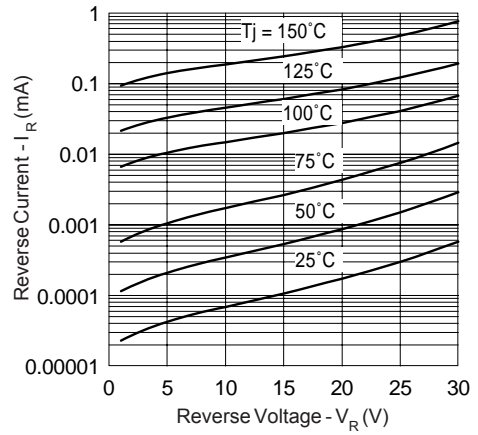

Fig. 2 - Typical Values Of Reverse Current Vs. Reverse Voltage (Per Leg)

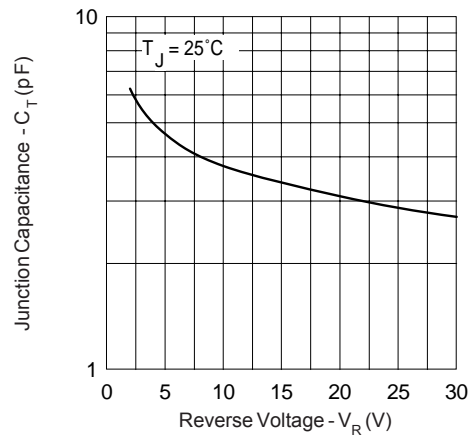

Fig. 3 - Typical Junction Capacitance Vs. Reverse Voltage (Per Leg)

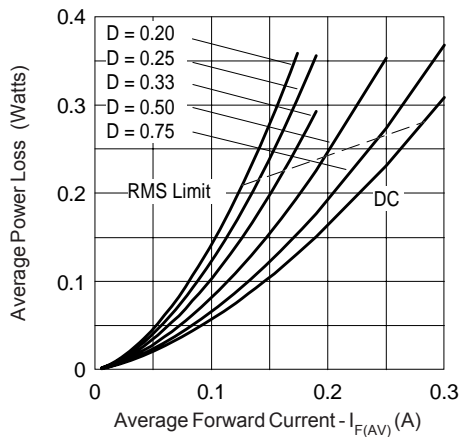

Fig. 4 - Forward Power Loss Characteristics

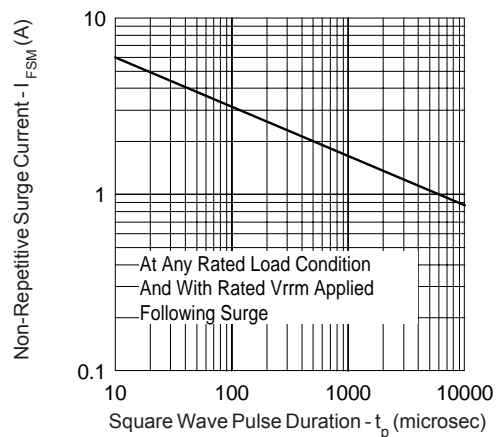
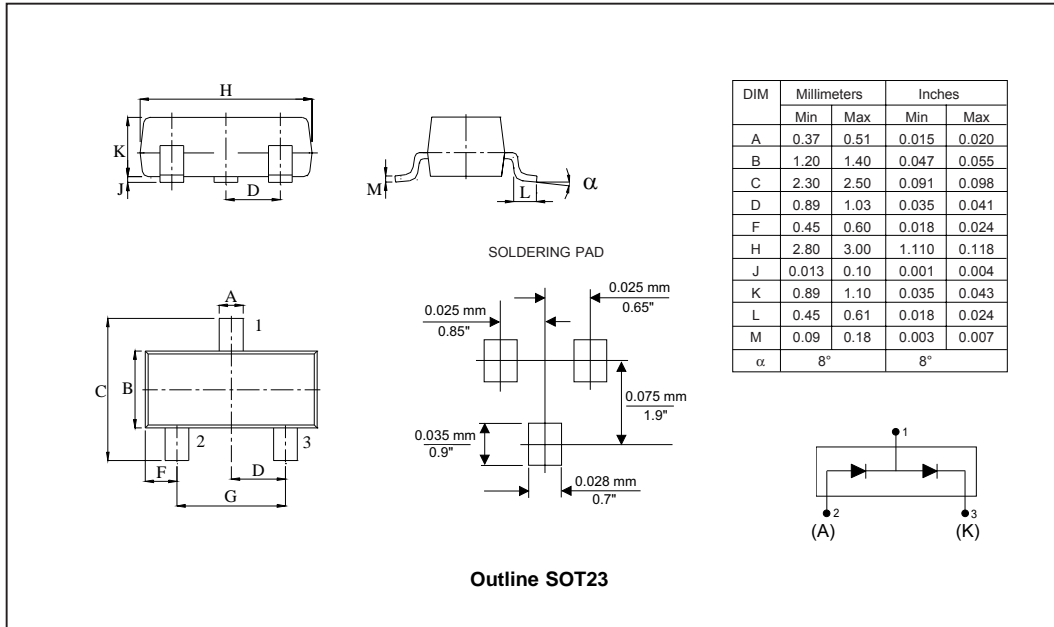
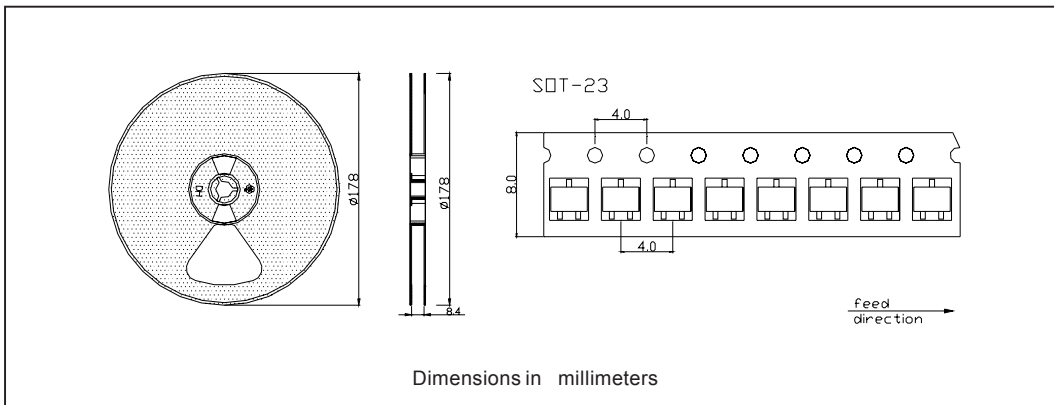

Fig. 5 - Max. Non-Repetitive Surge Current

Outline Table



Tape & Reel Information



Ordering Information Table

Device	Package	Marking	Configuration	Base qty	Delivery mode
BAT54S	SOT-23	HYWLC	Dual Series	3000	Tape & Reel

Data and specifications subject to change without notice.
This product has been designed and qualified for Industrial Level.
Qualification Standards can be found on IR's Web site.

International
IOR Rectifier

IR WORLD HEADQUARTERS: 233 Kansas St., El Segundo, California 90245, USA Tel: (310) 252-7105
TAC Fax: (310) 252-7309
Visit us at www.irf.com for sales contact information. 04/06