

# FS70VS-06

HIGH-SPEED SWITCHING USE

## FS70VS-06



- 10V DRIVE
- V<sub>DSS</sub> ..... 60V
- r<sub>DS (ON)</sub> (MAX) ..... 7.5mΩ
- I<sub>D</sub> ..... 70A
- Integrated Fast Recovery Diode (TYP.) ..... 85ns

## OUTLINE DRAWING

Dimensions in mm

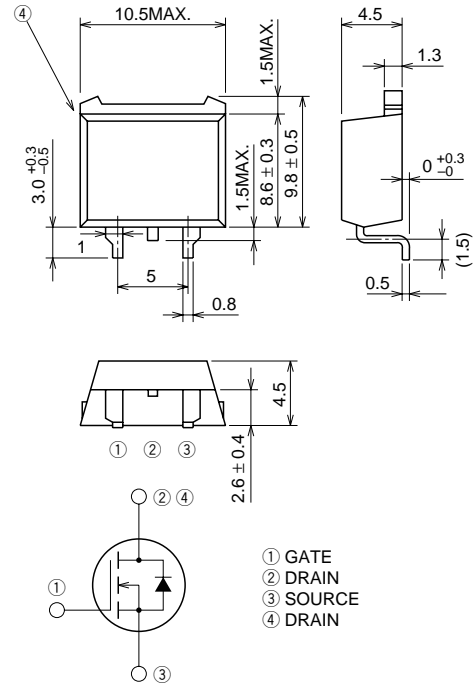

TO-220S

## APPLICATION

Motor control, Lamp control, Solenoid control  
DC-DC converter, etc.

## MAXIMUM RATINGS (T<sub>c</sub> = 25°C)

Symbol	Parameter	Conditions	Ratings	Unit
V <sub>DSS</sub>	Drain-source voltage	V <sub>GS</sub> = 0V	60	V
V <sub>GSS</sub>	Gate-source voltage	V <sub>DS</sub> = 0V	±20	V
I <sub>D</sub>	Drain current		70	A
I <sub>DM</sub>	Drain current (Pulsed)		280	A
I <sub>DA</sub>	Avalanche drain current (Pulsed)	L = 100μH	70	A
I <sub>S</sub>	Source current		70	A
I <sub>SM</sub>	Source current (Pulsed)		280	A
P <sub>D</sub>	Maximum power dissipation		125	W
T <sub>ch</sub>	Channel temperature		-55 ~ +150	°C
T <sub>stg</sub>	Storage temperature		-55 ~ +150	°C
—	Weight	Typical value	4.8	g

**ELECTRICAL CHARACTERISTICS** (Tch = 25°C)

Symbol	Parameter	Test conditions	Limits			Unit
			Min.	Typ.	Max.	
V(BR)DSS	Drain-source breakdown voltage	Id = 1mA, VGS = 0V	60	—	—	V
IGSS	Gate-source leakage current	VGS = ±20V, VDS = 0V	—	—	±0.1	μA
IDSS	Drain-source leakage current	VDS = 60V, VGS = 0V	—	—	0.1	mA
VGS(th)	Gate-source threshold voltage	Id = 1mA, VDS = 10V	2.0	3.0	4.0	V
rDS(ON)	Drain-source on-state resistance	Id = 35A, VGS = 10V	—	5.7	7.5	mΩ
VDS(ON)	Drain-source on-state voltage	Id = 35A, VGS = 10V	—	0.200	0.263	V
yfs	Forward transfer admittance	Id = 35A, VDS = 10V	50	70	—	S
Ciss	Input capacitance	VDS = 10V, VGS = 0V, f = 1MHz	—	6540	—	pF
Coss	Output capacitance		—	1640	—	pF
Crss	Reverse transfer capacitance		—	790	—	pF
td(on)	Turn-on delay time	VDD = 30V, Id = 35A, VGS = 10V, RGEN = RGS = 50Ω	—	95	—	ns
tr	Rise time		—	195	—	ns
td(off)	Turn-off delay time		—	290	—	ns
tf	Fall time		—	210	—	ns
VSD	Source-drain voltage	IS = 35A, VGS = 0V	—	1.0	1.5	V
Rth(ch-c)	Thermal resistance	Channel to case	—	—	1.0	°C/W
trr	Reverse recovery time	IS = 70A, dis/dt = -100A/μs	—	85	—	ns

**PERFORMANCE CURVES**

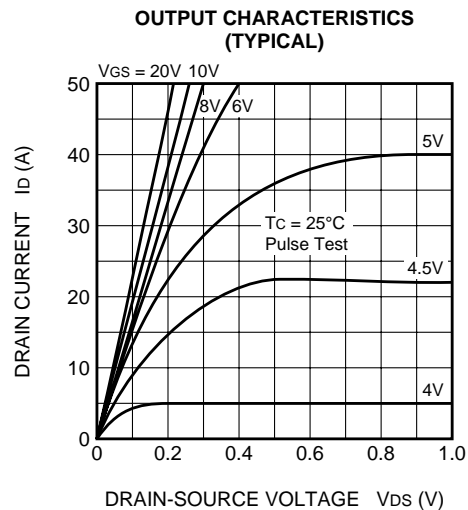
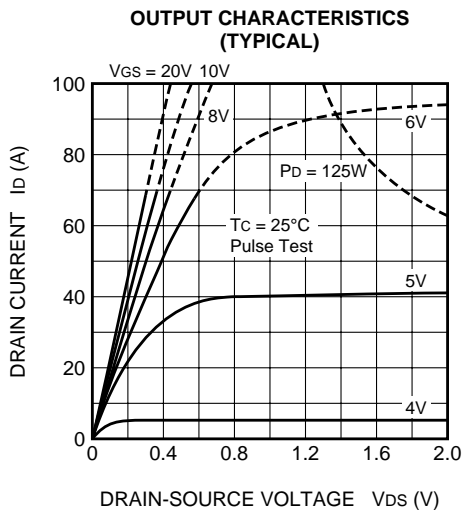
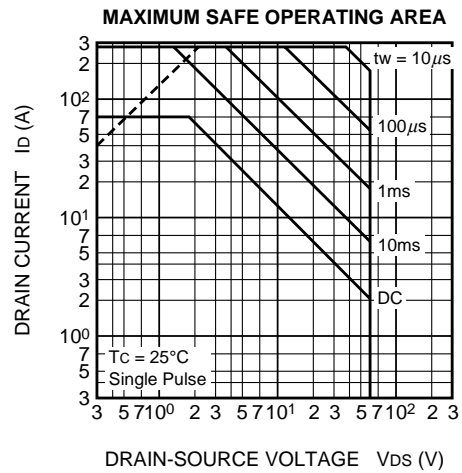
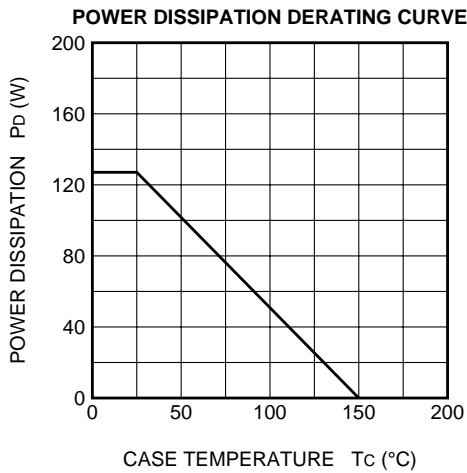

ON-STATE VOLTAGE VS. GATE-SOURCE VOLTAGE (TYPICAL)

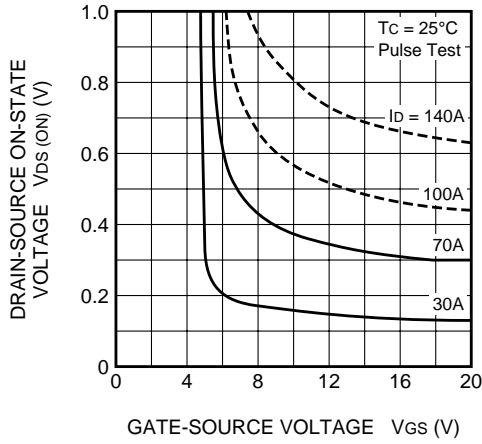

ON-STATE RESISTANCE VS. DRAIN CURRENT (TYPICAL)

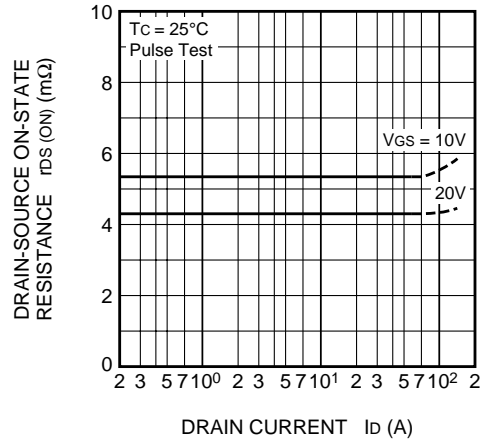

TRANSFER CHARACTERISTICS (TYPICAL)

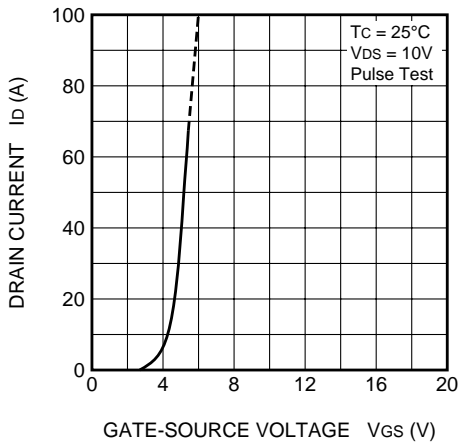

FORWARD TRANSFER ADMITTANCE VS. DRAIN CURRENT (TYPICAL)

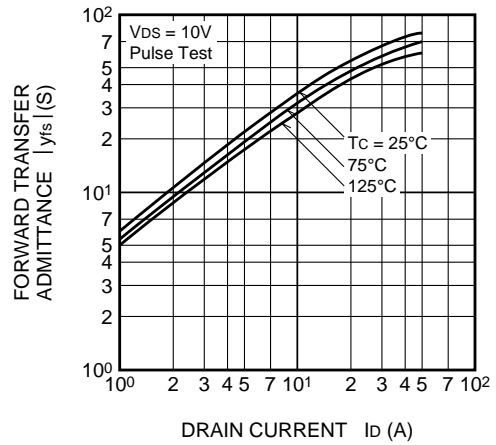

CAPACITANCE VS. DRAIN-SOURCE VOLTAGE (TYPICAL)

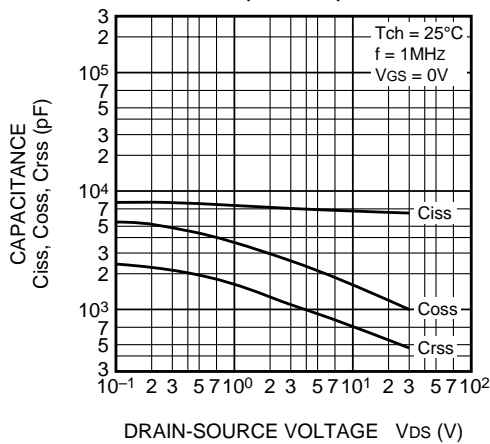

SWITCHING CHARACTERISTICS (TYPICAL)

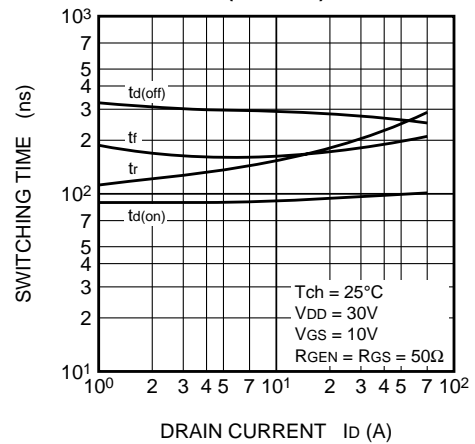

**GATE-SOURCE VOLTAGE VS. GATE CHARGE (TYPICAL)**

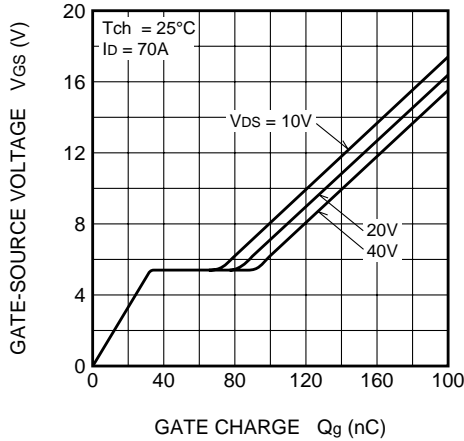

**SOURCE-DRAIN DIODE FORWARD CHARACTERISTICS (TYPICAL)**

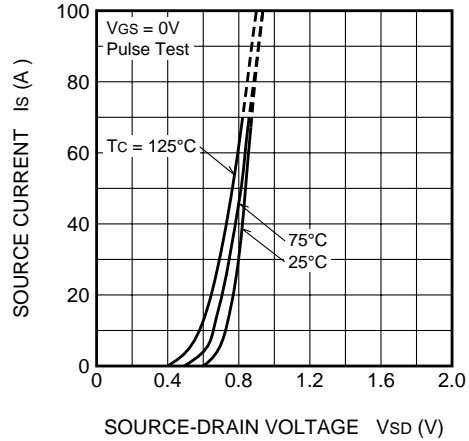

**ON-STATE RESISTANCE VS. CHANNEL TEMPERATURE (TYPICAL)**

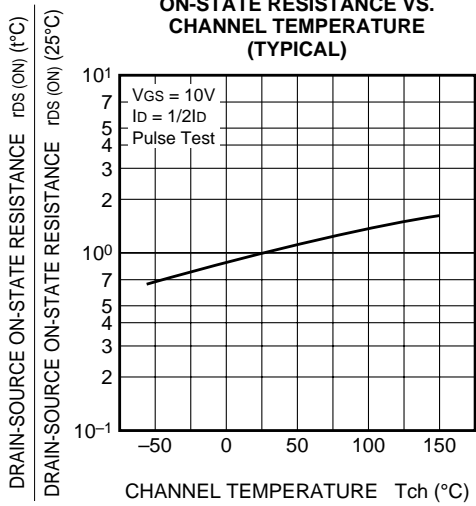

**THRESHOLD VOLTAGE VS. CHANNEL TEMPERATURE (TYPICAL)**

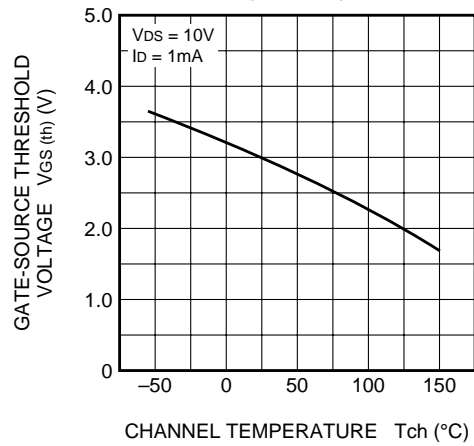

**BREAKDOWN VOLTAGE VS. CHANNEL TEMPERATURE (TYPICAL)**

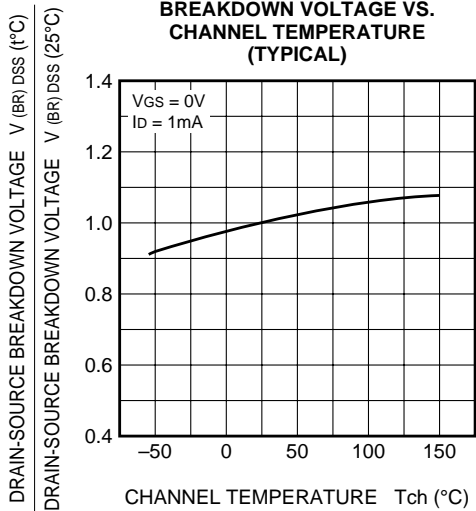

**TRANSIENT THERMAL IMPEDANCE CHARACTERISTICS**

