

NTC Thermistor

NTC THERMISTOR

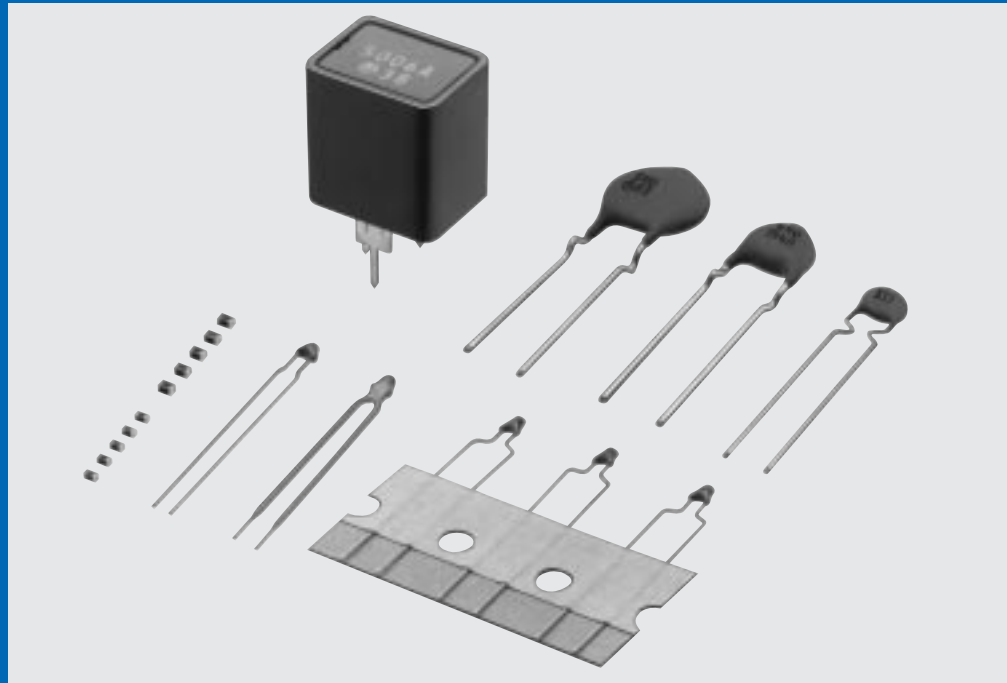

- For Temperature compensation
 - 0603/0805 size, Ni barriered SMD NTH5G1M/2M series
- For Temperature Sensor
 - Small High Precision NTH4G series
- For surge Current Suppression
 - Disc Radial type NTH7D to 22D series
 - Case type NTH5000 series
- For Temperature compensation
 - Disc Radial type NTH5D series

muRata

*Innovator
in Electronics*

Murata
Manufacturing Co., Ltd.

Cat.No.R44E-2

■ CONTENT

- Basic Characteristics2
- For temperature compensation
 - 0603/0805 size, Ni barriered SMD NTH5G1M/2M series.....3-6
- For Temperature Sensor
 - Small High Precision NTH4G Series7-10
- For Surge Current Suppression
 - Disc Radial Type
 - NTH7D to 22D Series11, 12
 - Case Type
 - NTH5000 Series13-15
- For Temperature Compensation
 - Disc Radial type NTH5D Series.....16, 17

■ BASIC CHARACTERISTICS

1. Zero-power resistance of Thermistor : R
 $R=R_0 \exp B(1/T-1/T_0)$ (1)
 R : Resistance in ambient temperature T(K)
 (K : absolute temperature)
 R₀ : Resistance in ambient temperature T₀(K)
 B : B-constant of Thermistor
2. B-constant
 as (1) formula
 $B= \ell n(R/R_0)/(1/T-1/T_0)$ (2)
3. Thermal dissipation Constant
 When spend electric power P(mW)in ambient temperature T₁, if Thermistor's temperature rises T₂, there is a formula as follows
 $P=C(T_2-T_1)$ (3)
 C : Thermal dissipation constant(mW/°C)
 Thermal dissipation constant change by dimensions,measure, measured condition etc.
4. Thermal Time Constant
 Period in which Thermistor's temperature will change 63.2% of its temperature difference from ambient temperature T₀ (°C) to T (°C).

■ RESISTANCE VS. TEMPERATURE

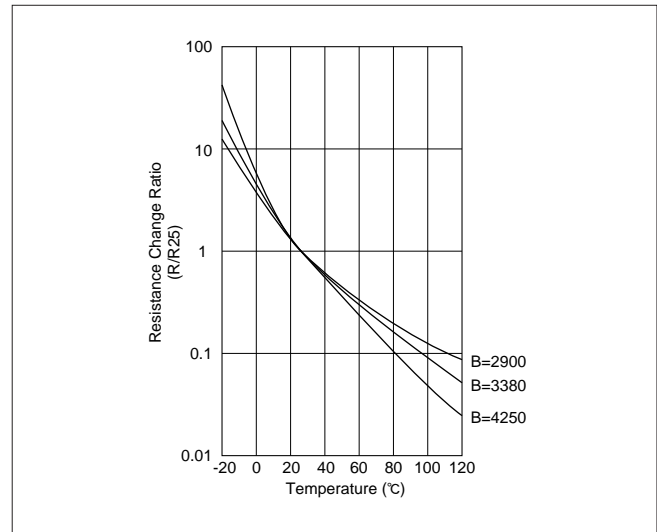

■ THERMAL TIME CONSTANT

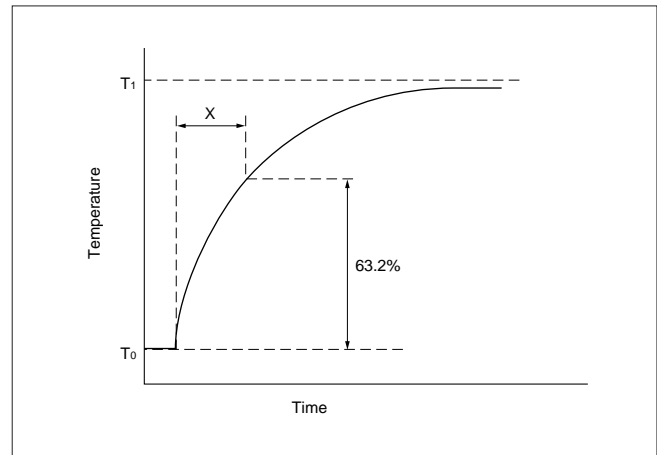

■ PERFORMANCE

Item	Condition
Resistance	It measures by zero-power in specified ambient temperature.
B-constant	It calculates between two specified ambient temperature by next formula. T and T ₀ is absolute temperature(K). $B= \frac{\ell n(R/R_0)}{1/T-1/T_0}$
Thermal Dissipation constant	It shows necessary electric power that Thermistor's temperature rises 1°C by self heating. It calculates by next formula.(mW/°C) $C= \frac{W}{T-T_0}$
Rated Electric Power	It shows necessary electric power that Thermistor's temperature rises 10°C by self heating in ambient temperature 25°C.
Max. Current	It shows maximum current that is able to apply to Thermistor continuously in specified ambient temperature.
Max. Operating Current	It is possible to keep Thermistor's temperature rising max. 1°C

Please inquire about test condition and Ratings.

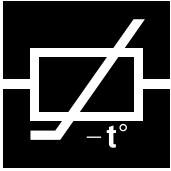

NTC THERMISTOR



Chip NTC Thermistor NTH5G1M/2M Series

Chip NTC Thermistor NTH5G1M/2M Series for Temperature Compensation and Sensing

0603/0805 sized Chip NTC Thermistor NTH5G1M/2M Series have Ni barrier termination and offers high stability in environment and wide resistance range in a constant size by unique inner construction.

FEATURES

1. High humidity resistant due to unique inner construction.
2. Excellent long time aging stability.
3. High accuracy : Tolerance of $\pm 5\%$ in resistance and $\pm 3\%$ in B-constant available.
4. Reflow/flow soldering possible.
5. 0603/0805 both size available.

APPLICATIONS

- Temperature compensation of transistor, IC, crystal oscillator of mobile communications equipments.
- Temperature sensor for rechargeable batteries
- Temperature compensation of LCD.
- Temperature compensation and sensing of car audio equipments(CD,MD,Tuner)
- Temperature compensation of several kinds of circuits.

PART NUMBERING

(*Please specify the part number when ordering.)

(Ex.)

NTH	5G	2	M	35A	472	K	04	TE
①	②	③	④	⑤	⑥	⑦	⑧	⑨

- ① NTC Thermistor
- ② Chip
- ③ Size (1 : 1.6X0.8mm, 2 : 2.0X1.25mm)
- ④ Ni barriered electrode
- ⑤ B-constant (3500 : 35A, 4050 : 40B)
- ⑥ Resistance (4.7k Ω : 472, 47k Ω : 473)
- ⑦ Resistance Tolerance (J : $\pm 5\%$ K : $\pm 10\%$)
- ⑧ Suffix
- ⑨ Packaging (TH : Paper Tape, TE : Plastic Tape)

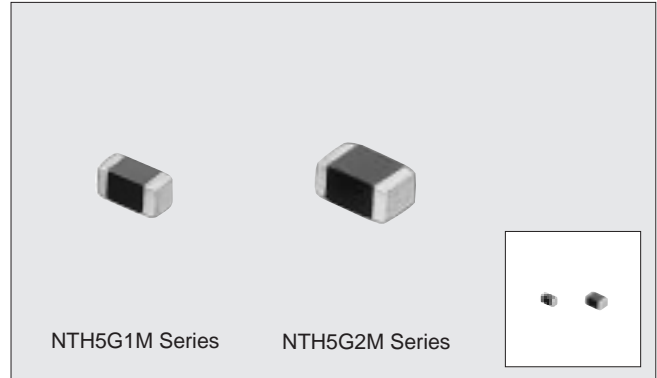

DIMENSIONS

Series	Dimensions (mm)			
	L	W	T	e
NTH5G1M	1.6 \pm 0.2	0.8 \pm 0.2	0.8 \pm 0.2	0.1 min.
NTH5G2M	2.0 \pm 0.3	1.25 \pm 0.3	0.9 \pm 0.3	0.1 min.

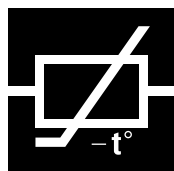

NTC THERMISTOR

Chip NTC Thermistor NTH5G1M/2M Series

RATINGS

NTH5G1M Series

Part Number	Resistance 25°C	B-constant 25/50°C(K)	Max. Current (mA) 25°C, in still air	Max. Operating Current (mA) 25°C, in still air(*)
NTH5G1M29A221□04TH	220Ω	2900	7.80	2.10
NTH5G1M31A471□04TH	470Ω	3100	5.40	1.40
NTH5G1M31B102□04TH	1.0kΩ	3150	3.70	1.00
NTH5G1M39B222□04TH	2.2kΩ	3950	2.60	0.67
NTH5G1M35A472□04TH	4.7kΩ	3500	1.70	0.46
NTH5G1M33B103□04TH	10kΩ	3380	1.20	0.31
NTH5G1M39B153□04TH	15kΩ	3950	1.00	0.25
NTH5G1M39B223□04TH	22kΩ	3950	0.83	0.21
NTH5G1M40B473□04TH	47kΩ	4050	0.57	0.14
NTH5G1M42B104□04TH	100kΩ	4250	0.39	0.10

NTH5G2M Series

Part Number	Resistance 25°C	B-constant 25/50°C(K)	Max. Current (mA) 25°C, in still air	Max. Operating Current (mA) 25°C, in still air(*)
NTH5G2M29A221□04TE	220Ω	2900	11.10	3.00
NTH5G2M29A331□04TE	330Ω	2900	9.10	2.40
NTH5G2M29B471□04TE	470Ω	2950	7.60	2.00
NTH5G2M31B102□04TE	1.0kΩ	3150	5.30	1.40
NTH5G2M39B152□04TE	1.5kΩ	3950	4.50	1.10
NTH5G2M39B222□04TE	2.2kΩ	3950	3.70	0.90
NTH5G2M39B332□04TE	3.3kΩ	3950	3.00	0.77
NTH5G2M35A472□04TE	4.7kΩ	3500	2.40	0.65
NTH5G2M36B103□04TE	10kΩ	3650	1.70	0.44
NTH5G2M39B153□04TE	15kΩ	3950	1.40	0.36
NTH5G2M39B223□04TE	22kΩ	3950	1.10	0.30
NTH5G2M40B333□04TE	33kΩ	4050	0.97	0.24
NTH5G2M40B473□04TE	47kΩ	4050	0.81	0.20
NTH5G2M42B104□04TE	100kΩ	4250	0.56	0.14

- : Resistance Tolerance (J : ±5%, K : ±10%)
 - Thermal Dissipation Constant : NTH5G1M Series around 1.0mW/°C (25°C, in still air)
NTH5G2M Series around 2.0mW/°C (25°C, in still air)
 - Rated Electric Power : NTH5G1M Series 10mW (25°C, in still air)
NTH5G2M Series 20mW (25°C, in still air)
 - Operating Temperature Range : -40 to +125°C
 - B-Constant Tolerance : ±3%
- (*) : Use Thermistor in current less than 1/10 of Maximum Operating Current.

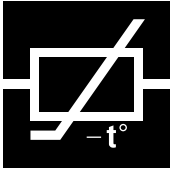

NTC THERMISTOR



Chip NTC Thermistor NTH5G1M/2M Series

■ DIMENSIONS OF TAPE

NTH5G1M Series (Paper Tape)

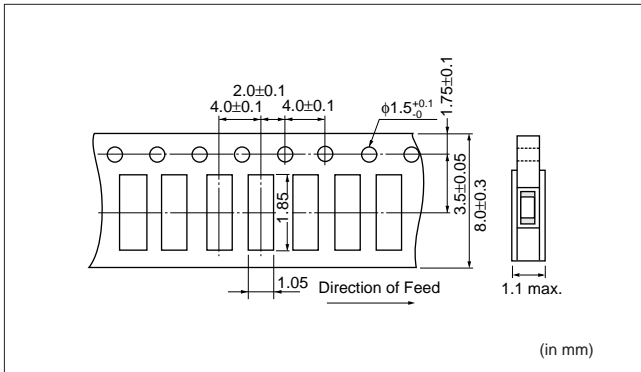

NTH5G2M Series (Plastic Tape)

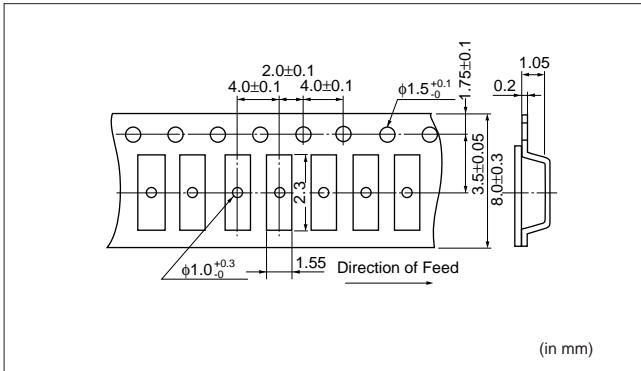

■ DIMENSIONS OF REEL

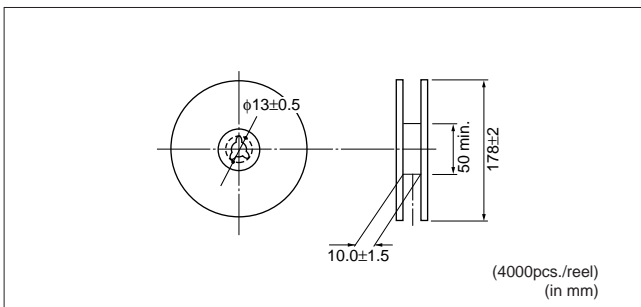

■ STANDARD LAND PATTERN

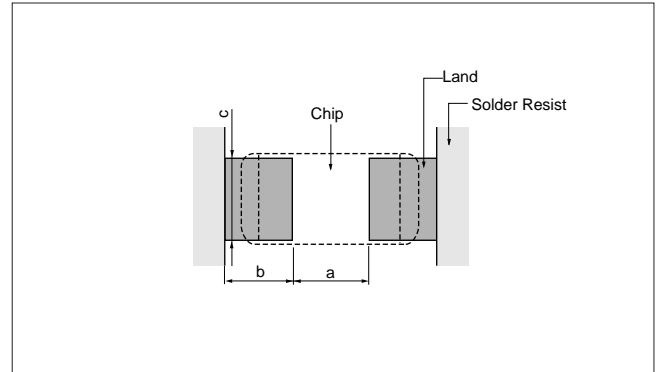

Reflow Soldering

(in mm)

Series	a	b	c
NTH5G1M	0.6-0.8	0.6-0.7	0.6-0.8
NTH5G2M	1.0-1.1	0.6-0.7	1.0-1.2

Flow Soldering

(in mm)

Series	a	b	c
NTH5G1M	0.6-1.0	0.8-0.9	0.6-0.8
NTH5G2M	1.0-1.1	0.9-1.0	1.0-1.2

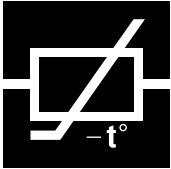

NTC THERMISTOR



Chip NTC Thermistor NTH5G1M/2M Series

■ SOLDERING TEMPERATURE AND TIME

The product is designed for reflow and flow soldering. Follow the soldering conditions specified by the slanted lines in the following graph. When soldering is repeated, the allowed soldering time is the accumulated time.

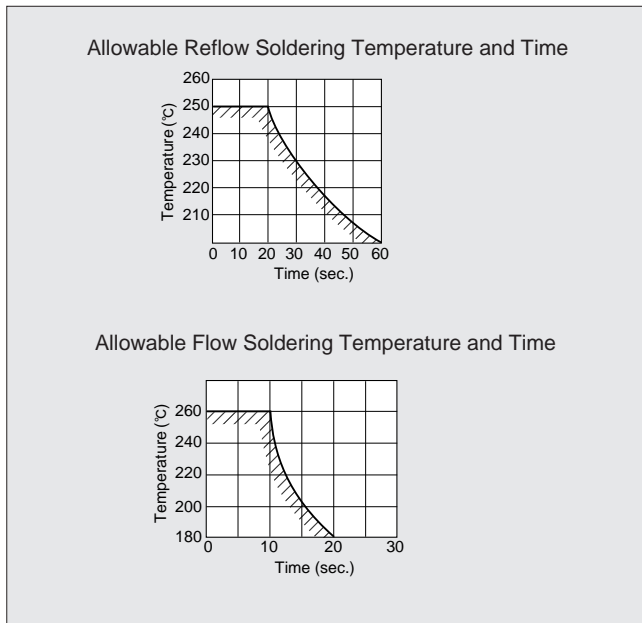

■ STANDARD SOLDERING CONDITIONS

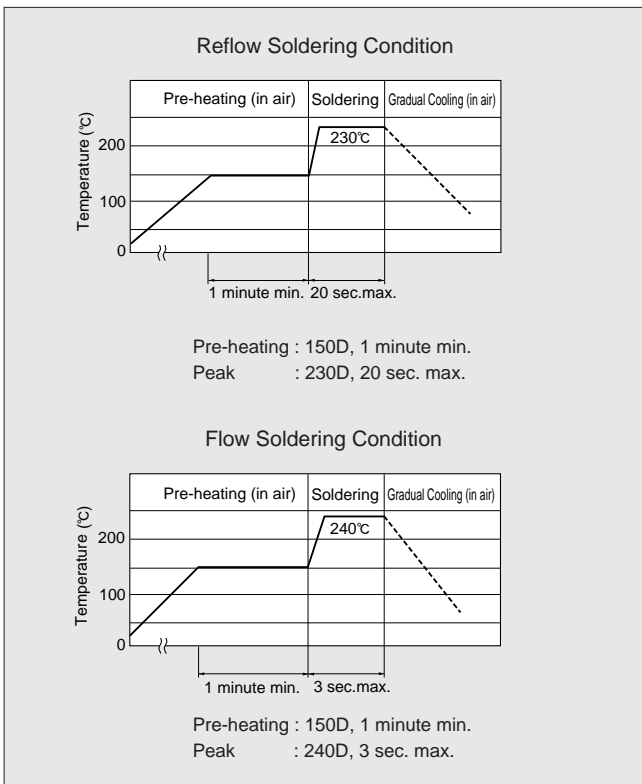

■ CLEANING CONDITION

1. When cleaning for removing flux is applied, pay attention as follows to avoid the decline of element characteristic or the deteriorate of electrode material.

Solvent	Dipping Cleaning	Ultrasonic Cleaning
Isopropyl Alcohol	Less than 5 min. at room temperature or Less than 2 min. 40D max.	Less than 1 min. 20W/ℓ Frequency of several 10 kHz to several 100kHz

2. A sufficient cleaning shall be applied to remove flux completely.
3. After cleaning, dry this product promptly.
4. Please contact us before using other solvents.

■ PRECAUTION

Applying the power exceeding Rated Electric Power may result to deterioration of characteristics, destruction of product or in the worst case, to catching fire. Do not apply the power exceeding Rated Electric Power.

■ NOTICE

1. Do not use the product under dewing condition or in liquid.
2. Storage Conditions

To keep solderability and characteristic of product from declining, following storage condition is recommended.

- ① Storage Condition
Temperature : -10 to +40D
Humidity : less than 75%RH (not dewing condition)
- ② Term
Please use thermistor within 6 months after shipment by first-in, first-out stocking system.
- ③ Handling after Unpackaging
After unpackaging reseal it promptly or store it inside a sealed container with a drying agent.
- ④ Place
Do not store this product in corrosive gas(SOx, Cl, etc.)or under sun-light.

■ MINIMUM QUANTITY (order in sets only)

4,000 pcs.

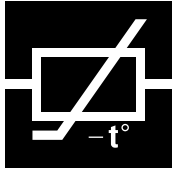

NTC THERMISTOR



Resin Coated Lead Type Thermistor NTH4G Series

Miniaturized and High-accuracy NTC Thermistor

NTH4G Series is sensor type NTC Thermistor to be useful in the normal temperature range developed by the unique ceramic technology and the automatic assembly.

FEATURES

1. High-accuracy of $\pm 1\%$
 $\pm 1\%$ of resistance and B-Constant tolerance is realized due to uniform thickness by the precise sheet forming method.
2. Quick response
 NTH4G provides faster response time due to its smaller size.
3. Taping type is available.(standard series)
4. Strong lead strength
 Original lead-wiring technique assures reliable connection. It can be formed and bent flexibly according to the mounting condition.
5. Lead Coating Series
 The lead wires of Lead coating series are coated with strong and flexible resin.

APPLICATIONS

1. Temperature sensor for rechargeable batteries
2. Temperature sensor for battery charging circuits
3. Temperature sensor for head of printers
4. Temperature sensor for DC fan motors
5. Temperature sensor for home appliance equipments

PART NUMBERING

(*Please specify the part number when ordering.)

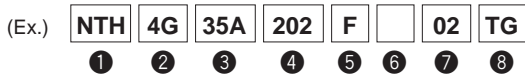

- ① NTC Thermistor
- ② Resin Coated Lead Type
- ③ B-Constant (35A:3500K, 40B:4050K)
- ④ Resistance at 25°C R (2k Ω :202, 20k Ω :203)
- ⑤ Resistance Tolerance at 25°C (F: $\pm 1\%$, E: $\pm 3\%$)
- ⑥ Lead Wires Variation (Q:Lead Coating Series, None:Standard Series)
- ⑦ Suffix
- ⑧ Taping Type

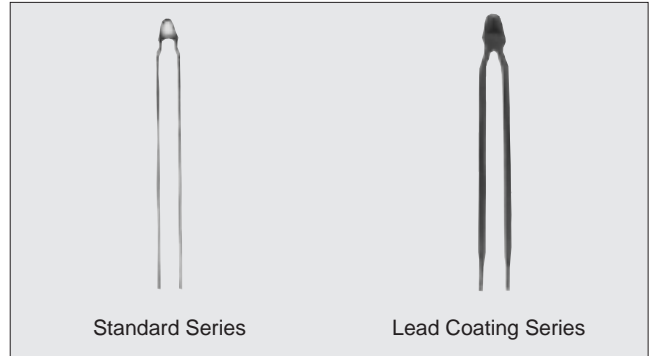

DIMENSIONS

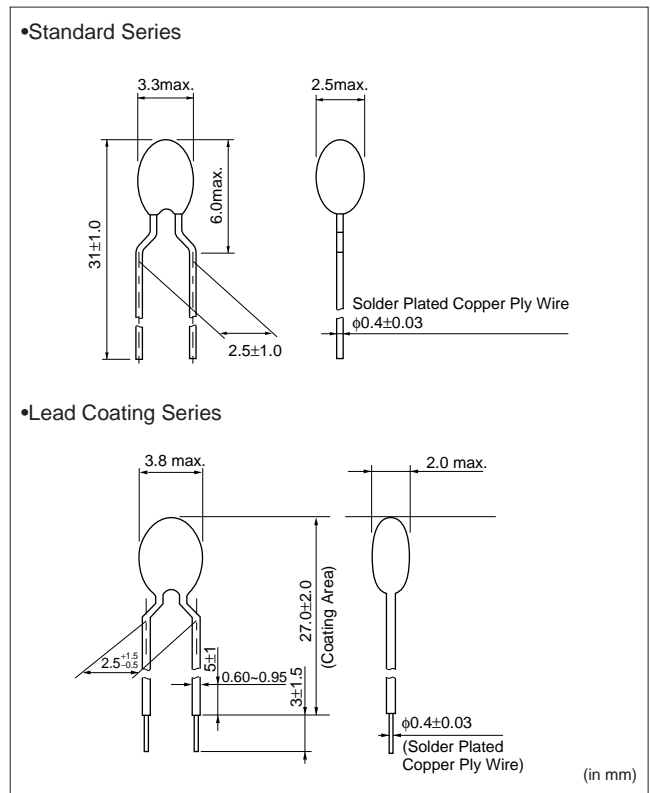

Note1 : Please design I/O pattern so that the impedance matches 50 Ω including land pattern. Note2 : The material of PCB is the epoxy resin of glass fabric base. ($\epsilon_r=4.8$) Thickness is 1.0 mm.

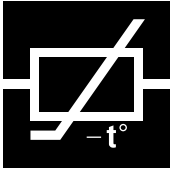

NTC THERMISTOR



Resin Coated Lead Type Thermistor NTH4G Series

RATINGS

Standard Series

Part Number	Resistance 25°C	B-Constant		Max. Current 25°C (in still air)	Max. Operating Current* 25°C (in still air)
		25/50°C	25/85°C (reference value)		
NTH4G35A202F02	2kΩ±1%	3500K±1%	3525K	3.84mA	1.05mA
NTH4G37A502F02	5kΩ±1%	3700K±1%	3738K	2.46mA	0.68mA
NTH4G39A103F02	10kΩ±1%	3900K±1%	3935K	1.76mA	0.46mA
NTH4G33B103F01	10kΩ±1%	3380K±1%	3435K	1.70mA	0.45mA
NTH4G40B203F01	20kΩ±1%	4050K±1%	4080K	1.25mA	0.31mA
NTH4G41A303F01	30kΩ±1%	4100K±1%	4131K	1.02mA	0.26mA
NTH4G41B503F01	50kΩ±1%	4150K±1%	4213K	0.79mA	0.20mA
NTH4G42B104F01	100kΩ±1%	4250K±1%	4315K	0.56mA	0.14mA

- Resistance Tolerance ±3% available
- Thermal Dissipation Constant : 2.1mW/°C (at 25°C, in still air)
- Thermal Time Constant : less than 7sec. (in still air)

- Rated Electric Power : 21mW (at 25°C, in still air)
- Operating Temperature : -40 to +125°C
- Lead wires cut variation is available. Please consult us when it is necessary.

Lead Coating Series

Part Number	Resistance 25°C	B-Constant		Max. Current 25°C (in still air)	Max. Operating Current* 25°C (in still air)
		25/50°C	25/85°C (reference value)		
NTH4G33B103FQ10	10kΩ±1%	3380K±1%	3435K	1.70mA	0.45mA
NTH4G42B104FQ10	100kΩ±1%	4250K±1%	4315K	0.56mA	0.14mA

- Other characteristics correspond to Standard Series.
- * Use Thermistor in current less than 1/10 of maximum operating current.

TAPING DIMENSIONS

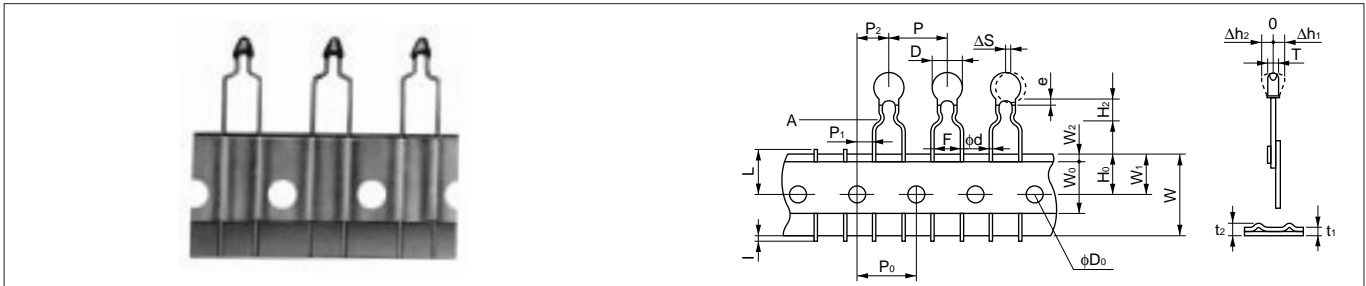

Item	Code	Dimension(mm)
Pitch of Component	P	12.7
Pitch of Sprocket Hole	P ₀	12.7±0.3
Lead Spacing	F	5.0 ^{+0.2} _{-0.2}
Lead Length from Hole Center to Component Center	P ₂	6.35±1.3
Lead Length from Hole Center to Lead	P ₁	3.85±0.8
Body Diameter	D	MAX. 3.3
Deviation along Tape, Left or Right	ΔS	0±2.0
Carrier Tape Width	W	18.0±0.5
Position of Sprocket Hole	W ₁	9.0±0.5
Lead Distance between Reference and Bottom Planes	H ₀	16.0±1.0
Height of Component	H ₂	MAX. 4.0
Overflow of Lead	l	+0.5 to -1.0
Diameter of Sprocket Hole	D ₀	4.0±0.1
Lead Diameter	d	0.4±0.03
Total Tape Thickness	t ₁	0.6±0.3
Total Thickness (Tape and Lead Wire)	t ₂	MAX. 1.5
Deviation Across Tape	Δh ₁ , h ₂	MAX. 1.0
Portion to Cut in Case of Defect	L	11.0 ^{+0.2} _{-0.2}
Hole Down Tape Width	W ₀	MIN. 11.0
Hole Down Tape Position	W ₂	1.5±1.5
Coating Extension on Lead	e	to line A
Thickness	T	MAX. 2.5

- Taping type is available for standard series only.

MINIMUM QUANTITY (order in sets only)

- Standard Series, Lead Coating Series : 100pcs.
- Taping type : 2500pcs./flat pack

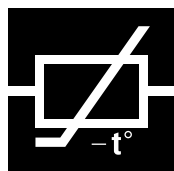

NTC THERMISTOR



Resin Coated Lead Type Thermistor NTH4G Series

■ TEMPERATURE VS. RESISTANCE CHARACTERISTICS

Temp. (°C)	NTH4G35A202F Type			NTH4G37A502F Type			NTH4G39A103F Type			NTH4G33B103F Type		
	Resistance(kΩ)			Resistance(kΩ)			Resistance(kΩ)			Resistance(kΩ)		
	Low	Center	High	Low	Center	High	Low	Center	High	Low	Center	High
-40	42.859	44.657	46.526	118.390	123.484	128.781	332.325	347.808	363.977	188.021	195.652	203.573
-35	32.249	33.505	34.807	88.747	92.295	95.975	238.323	248.591	259.275	142.788	148.171	153.741
-30	24.504	25.388	26.302	67.127	69.614	72.185	173.098	179.973	187.102	109.522	113.347	117.294
-25	18.777	19.402	20.046	51.112	52.860	54.662	127.191	131.832	136.629	84.823	87.559	90.374
-20	14.516	14.961	15.417	39.246	40.480	41.748	94.524	97.679	100.930	66.270	68.237	70.255
-15	11.327	11.644	11.969	30.400	31.275	32.172	70.962	73.119	75.334	52.229	53.650	55.104
-10	8.906	9.133	9.365	23.718	24.339	24.975	53.820	55.301	56.817	41.477	42.506	43.557
-5	7.035	7.198	7.363	18.710	19.154	19.607	41.237	42.257	43.299	33.147	33.892	34.651
0	5.600	5.716	5.834	14.831	15.148	15.469	31.878	32.582	33.298	26.678	27.219	27.767
5	4.489	4.571	4.655	11.741	11.964	12.189	24.839	25.324	25.815	21.630	22.021	22.417
10	3.623	3.682	3.741	9.365	9.520	9.677	19.514	19.847	20.183	17.643	17.926	18.210
15	2.946	2.987	3.029	7.526	7.624	7.742	15.453	15.679	15.907	14.472	14.674	14.877
20	2.409	2.437	2.466	6.086	6.160	6.234	12.326	12.478	12.630	11.938	12.081	12.224
25	1.980	2.000	2.020	4.950	5.000	5.050	9.900	10.000	10.100	9.900	10.000	10.100
30	1.632	1.651	1.671	4.034	4.082	4.131	7.971	8.068	8.166	8.217	8.315	8.413
35	1.352	1.371	1.389	3.308	3.354	3.401	6.459	6.552	6.645	6.854	6.948	7.043
40	1.126	1.143	1.161	2.729	2.773	2.816	5.267	5.353	5.440	5.745	5.834	5.923
45	0.942	0.958	0.974	2.259	2.299	2.340	4.320	4.399	4.479	4.834	4.917	5.001
50	0.792	0.807	0.822	1.877	1.914	1.952	3.563	3.635	3.708	4.084	4.161	4.239
55	0.670	0.683	0.697	1.573	1.607	1.641	2.954	3.020	3.086	3.464	3.535	3.607
60	0.569	0.582	0.594	1.325	1.356	1.387	2.462	2.521	2.582	2.949	3.014	3.081
65	0.485	0.497	0.508	1.121	1.149	1.177	2.062	2.115	2.170	2.526	2.586	2.647
70	0.415	0.426	0.436	0.953	0.978	1.003	1.736	1.783	1.832	2.173	2.228	2.283
75	0.358	0.367	0.377	0.811	0.834	0.857	1.467	1.510	1.553	1.875	1.925	1.976
80	0.309	0.318	0.326	0.693	0.714	0.734	1.245	1.284	1.323	1.623	1.669	1.715
85	0.268	0.276	0.284	0.594	0.612	0.631	1.061	1.096	1.131	1.411	1.452	1.495
90	0.233	0.240	0.247	0.510	0.527	0.544	0.908	0.939	0.971	1.230	1.268	1.307
95	0.203	0.210	0.216	0.441	0.456	0.471	0.781	0.808	0.837	1.075	1.110	1.145
100	0.178	0.183	0.189	0.383	0.396	0.410	0.674	0.698	0.724	0.942	0.974	1.006
105	0.156	0.161	0.166	0.333	0.345	0.358	0.583	0.605	0.628	0.829	0.858	0.888
110	0.137	0.142	0.147	0.291	0.302	0.313	0.507	0.527	0.547	0.732	0.758	0.785
115	0.121	0.125	0.130	0.255	0.264	0.275	0.442	0.460	0.479	0.647	0.671	0.696
120	0.107	0.111	0.115	0.223	0.232	0.241	0.386	0.403	0.420	0.574	0.596	0.619
125	0.096	0.099	0.103	0.197	0.205	0.213	0.339	0.354	0.369	0.511	0.531	0.552

■ RESISTANCE TOLERANCE VS. TEMPERATURE (Resistance Tolerance ±1% at 25°C)

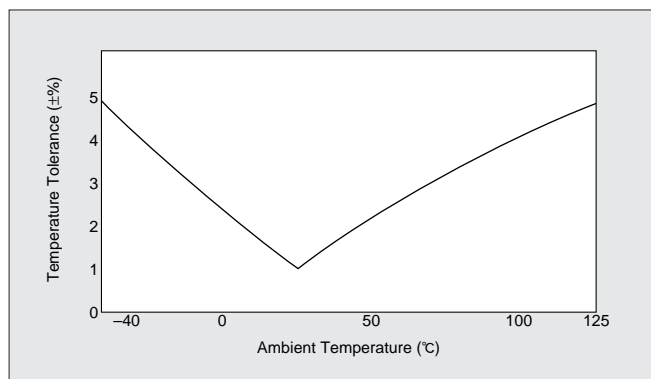

■ TEMPERATURE TOLERANCE VS. TEMPERATURE (Resistance Tolerance ±1% at 25°C)

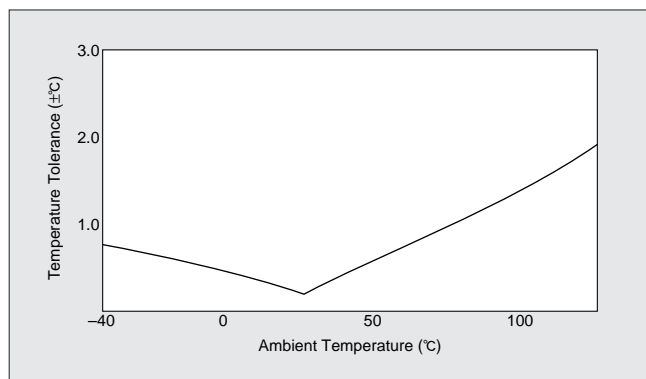

Above graph expresses tolerance of resistance and temperature against a center value at each ambient temperature. According to above graph, NTH4G with resistance tolerance ±1% at 25°C provides temperature detection within ±2°C between -40°C and +125°C.

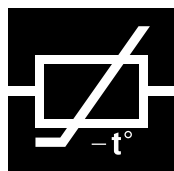

NTC THERMISTOR

Resin Coated Lead Type Thermistor NTH4G Series

■ TEMPERATURE VS. RESISTANCE CHARACTERISTICS

Temp. (°C)	NTH4G40B203F Type			NTH4G41A303F Type			NTH4G41B503F Type			NTH4G42B104F Type		
	Resistance(kΩ)			Resistance(kΩ)			Resistance(kΩ)			Resistance(kΩ)		
	Low	Center	High	Low	Center	High	Low	Center	High	Low	Center	High
-40	700.008	733.007	767.485	1097.262	1149.500	1204.104	1859.709	1948.575	2041.484	4059.035	4256.752	4463.654
-35	502.881	524.831	547.685	785.054	819.651	855.688	1328.527	1387.289	1448.506	2876.261	3005.888	3141.042
-30	365.460	380.184	395.462	568.281	591.391	615.380	960.265	999.456	1040.143	2062.776	2148.514	2237.591
-25	267.924	277.845	288.106	415.020	430.529	446.573	702.528	728.895	756.177	1497.800	1555.020	1614.264
-20	198.531	205.260	212.196	306.393	316.870	327.672	519.195	537.039	555.440	1098.895	1137.312	1176.955
-15	149.036	153.642	158.374	229.194	236.337	243.678	387.052	399.167	411.621	813.431	839.314	865.934
-10	112.855	116.016	119.254	172.958	177.842	182.864	291.216	299.469	307.927	607.840	625.338	643.275
-5	85.960	88.125	90.336	131.298	134.630	138.033	220.570	226.186	231.921	457.312	469.127	481.198
0	66.039	67.522	69.032	100.542	102.816	105.131	168.570	172.393	176.285	347.243	355.224	363.353
5	51.154	52.168	53.197	77.635	79.183	80.755	130.250	132.857	135.503	266.643	272.045	277.529
10	39.927	40.617	41.314	60.411	61.460	62.521	101.322	103.089	104.875	206.172	209.803	213.477
15	31.382	31.847	32.315	47.342	48.045	48.754	79.248	80.430	81.621	160.304	162.713	165.141
20	24.843	25.151	25.461	37.369	37.834	38.300	62.423	63.201	63.982	125.545	127.117	128.696
25	19.800	20.000	20.200	29.700	30.000	30.300	49.500	50.000	50.500	99.000	100.000	101.000
30	15.819	16.014	16.210	23.663	23.955	24.240	39.338	39.825	40.315	78.240	79.215	80.193
35	12.718	12.902	13.088	18.972	19.249	19.528	31.458	31.918	32.382	62.232	63.150	64.075
40	10.286	10.457	10.630	15.304	15.560	15.819	25.308	25.733	26.163	49.803	50.649	51.505
45	8.371	8.527	8.686	12.423	12.657	12.894	20.489	20.877	21.270	40.116	40.885	41.664
50	6.851	6.993	7.137	10.142	10.354	10.569	16.683	17.034	17.390	32.503	33.195	33.898
55	5.643	5.771	5.901	8.334	8.525	8.719	13.615	13.929	14.249	26.396	27.014	27.643
60	4.674	4.789	4.906	6.887	7.058	7.232	11.159	11.439	11.725	21.531	22.079	22.639
65	3.889	3.992	4.097	5.717	5.869	6.025	9.236	9.485	9.741	17.740	18.226	18.724
70	3.251	3.343	3.437	4.769	4.905	5.044	7.684	7.906	8.133	14.693	15.124	15.566
75	2.727	2.809	2.893	3.992	4.113	4.237	6.417	6.614	6.816	12.217	12.598	12.990
80	2.298	2.371	2.446	3.356	3.463	3.574	5.383	5.558	5.738	10.205	10.542	10.890
85	1.955	2.020	2.087	2.849	2.945	3.044	4.531	4.686	4.846	8.554	8.852	9.160
90	1.671	1.729	1.789	2.430	2.516	2.605	3.829	3.967	4.109	7.200	7.463	7.736
95	1.424	1.476	1.529	2.067	2.143	2.222	3.250	3.373	3.499	6.088	6.321	6.562
100	1.217	1.264	1.312	1.764	1.832	1.903	2.770	2.878	2.991	5.167	5.374	5.588
105	1.044	1.085	1.128	1.510	1.571	1.633	2.368	2.465	2.565	4.401	4.585	4.775
110	0.898	0.935	0.973	1.297	1.350	1.407	2.032	2.118	2.207	3.762	3.925	4.094
115	0.779	0.812	0.847	1.123	1.171	1.222	1.751	1.828	1.908	3.231	3.376	3.527
120	0.679	0.708	0.739	0.976	1.019	1.065	1.514	1.583	1.655	2.785	2.913	3.048
125	0.590	0.617	0.644	0.846	0.886	0.927	1.312	1.374	1.438	2.405	2.520	2.640

■ PRECAUTION

- Applying the power exceeding rated electric power may result to deterioration of characteristics, destruction of product, or in the worst case, to catch fire.
Do not apply the power exceeding rated electrical power.

■ NOTICE

- Do not use the product under dewing condition or in liquid.
- Storage Condition
To keep solderability and characteristic of product from declining, following storage condition is recommended.
 - Storage condition
Temperature: -10°C to 40°C
Humidity: less than 75% RH
(not dewing condition)
 - Term
Please use thermistor within 3 month after shipment

by first-in first-out stocking system.

- Handling after unpacking
After unpacking of the minimum package, reseal it promptly or store it inside sealed container with a drying agent.
- Place
Do not store this product in corrosive gas(SOX,Cl etc.) or under sun-light.
- Do not touch the body by soldering iron.
The soldering point shall be 5 mm away from the top of the body.(In case of Lead Coating Series,do not touch the lead coating area by soldering iron.)
- Do not apply an excessive force(more than 2.5N) to the lead. Otherwise, it may cause break off of junction between lead and element, or may crack element.
Therefore, hold of body side lead wire when cutting or bending leadwires.

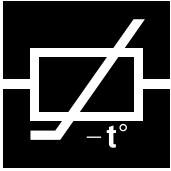

NTC THERMISTOR



NTH7D to 22D Series for surge Current Suppression

Extremely Effective in Suppressing Surge Current

NTH7D to 22D series NTC Thermistor effectively suppress surge current which are generated when switching power regulators or similar switches are turned on.

FEATURES

1. Lead-type Thermistor occupy a very small area and allow high-density packaging.
2. Most suitable for switching power supplies less than 100W.
3. Excellent recovery characteristics due to resin coating with excellent heat characteristics.
4. highly reliable.

APPLICATIONS

- Switching power supplies •CRT monitors •Color televisions
- VCR-Power supplies •Other power circuits

PART NUMBERING

(*Please specify the part number when ordering.)



- ① Murata Thermistor
- ② Diameter of element
- ③ Resistance at 25D(8Ω : 8R0, 12Ω : 120)
- ④ Resistance tolerance at 25D(L : ±15%)
- ⑤ Suffix

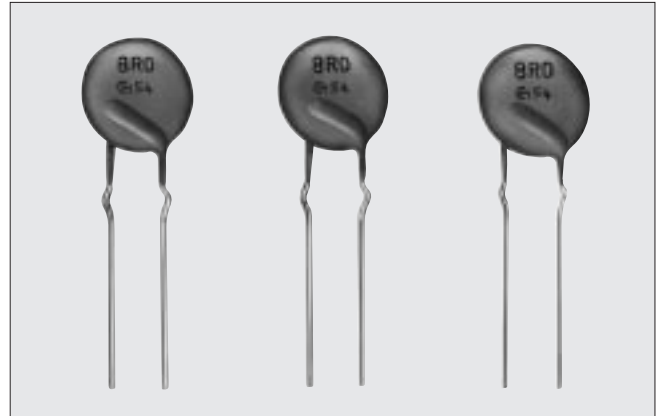

DIMENSIONS

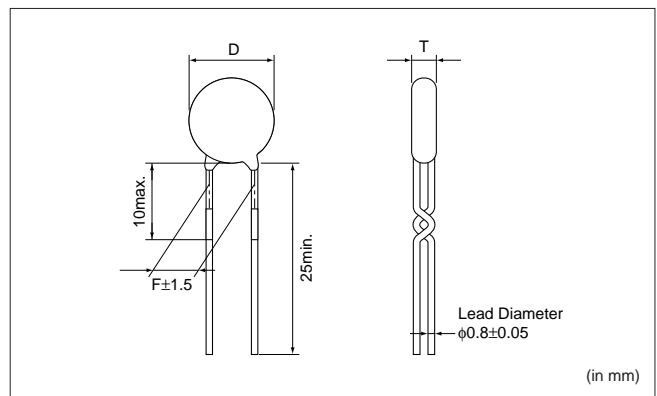

RATINGS

Part Number	Resistance (25°C)	Max. Current(Arms)		Typical Dissipation Constant (mw/°C)	Max. Capacity of Capacitor (μF) at 100V	Dimension(mm)		
		25°C	55°C			D max.	T max.	F
NTH22D3ROLA	3Ω±15%	5.1	4.5	23.3	5000	25	8	10
NTH22D4ROLA	4Ω±15%	4.4	3.9	22.3	5000	25	8	10
NTH22D6ROLA	6Ω±15%	3.6	3.2	23.8	5000	25	8	10
NTH18D4ROLA	4Ω±15%	3.7	3.3	16.7	1800	20	7	10
NTH18D6ROLA	6Ω±15%	3.3	2.9	18.4	1800	20	7	10
NTH18D8ROLA	8Ω±15%	2.8	2.5	18.2	1800	20	7	10
NTH13D8ROLA	8Ω±15%	2.7	2.4	16.4	1200	16	5.5	7.5
NTH13D12OLA	12Ω±15%	2.2	1.9	17.1	1200	16	5.5	7.5
NTH13D16OLA	16Ω±15%	2.0	1.7	14.5	1200	16	5.5	7.5
NTH11D5ROLA	5Ω±15%	2.8	2.5	12.6	600	14	6	7.5
NTH11D8ROLA	8Ω±15%	2.4	2.1	12.9	600	14	6	7.5
NTH9D100LA	10Ω±15%	1.9	1.6	10.8	200	11	6	7.5
NTH9D160LA	16Ω±15%	1.4	1.2	10.0	200	11	6	7.5
NTH7D220LA	22Ω±15%	1.1	1.0	9.0	300	9.5	6	7.5

- Operating Temp. Range : -30°C to +160°C
- NTH7D to NTH13D type : Taping type available.

MINIMUM QUANTITY (order in sets only)
100pcs (bulk)

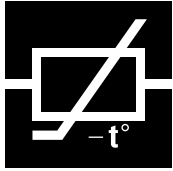

NTC THERMISTOR



For Inrush Current Suppression **NTH5000** Series

Extremely Effective in Suppressing Inrush Current

NTH5000 series NTC Thermistor effectively suppress rush currents which arise when switching power regulators or similar switches are turned on.

FEATURES

1. Case type structure maintains lower surface temperature.
2. Low surface temperature reduces the thermal effect on peripheral components contacting it, thus allowing high density assembling.
3. The case type structure is ideal for large current applications.
4. The absence of soldering and resin coating on the NTC element ensures long life.
5. Capable of withstanding abnormal current caused by the failure of other circuit components.

APPLICATIONS

- Switching power regulators•Monitor television sets
- Color television sets •Other power circuits

INTERNAL CONNECTION

- 1) Single element models :
An NTC element is connected between two terminals.
- 2) Dual element models :
Two NTC elements are connected between terminals 1 and 2, and between terminals 2 and 3.



DIMENSIONS

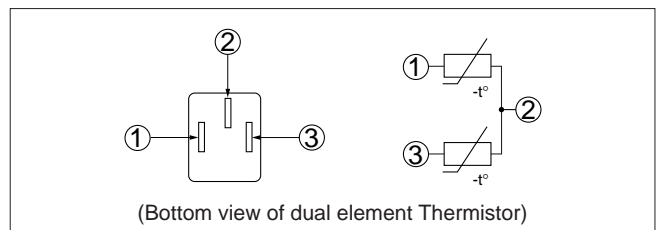
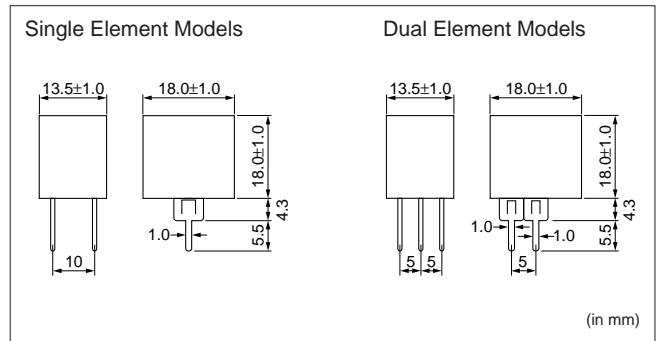

RATINGS

Single Element Models

Part Number	Resistance (25°C)	Max. Current(Arms)		Typical Dissipation Constant(mw/°C)	Operating Temp Range	Max. Capacity of Capacitor (μF)at 100V
		25°C	55°C			
NTH5046	8Ω±15%	2.8	2.5	8.7	-10 to +130°C	1200
NTH5004A	11Ω±15%	2.5	2.2	8.7		1200
NTH5005A	16Ω±15%	2.5	2.2	8.7		1200
NTH5047	22Ω±15%	2.2	2.0	8.7		1200

Dual Element Models

Part Number	Resistance (25°C)	Max. Current(Arms)		Typical Dissipation Constant(mw/°C)	Operating Temp Range	Max. Capacity of Capacitor (μF)at 100V
		25°C	55°C			
NTH5049	4Ω±15%	4.5	4.0	17.0	-10 to +130°C	1200
NTH5006A	8Ω±15%	3.9	3.5	17.0		1200

*Parallel resistance value of dual elements.

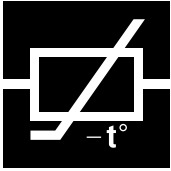

NTC THERMISTOR



For Inrush Current Suppression NTH5000 Series

APPLICATION CIRCUIT

The max. capacity of capacitor in RATINGS shows the max. value of smoothing capacitor in the below figure.

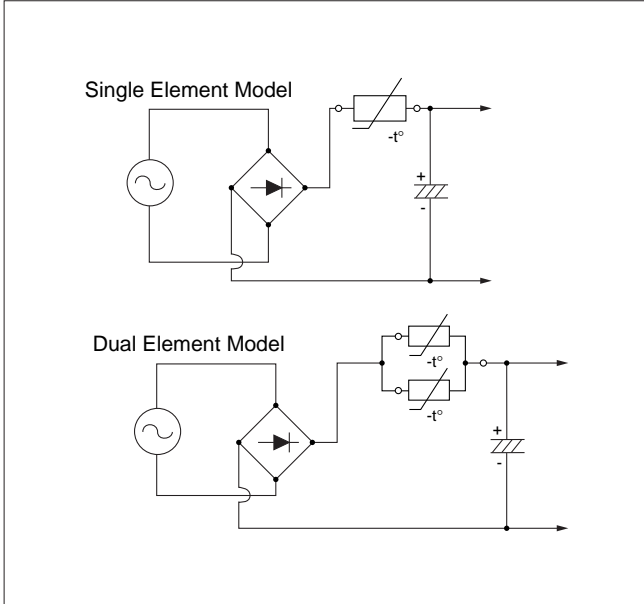

LIFE CHARACTERISTICS

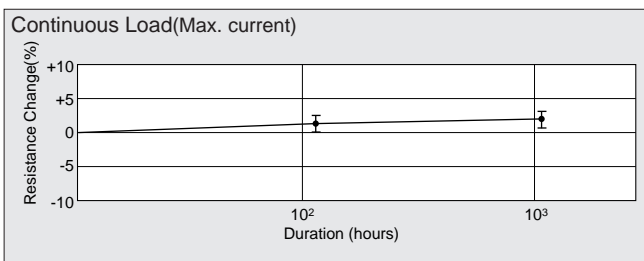
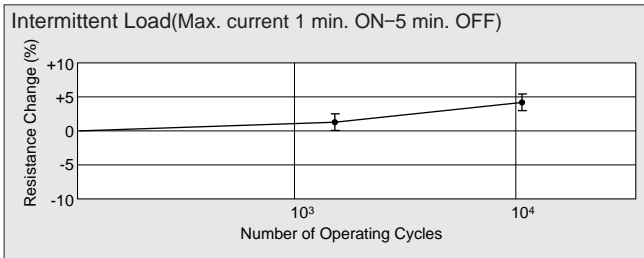

DETERMINATION OF ALLOWABLE CURRENT

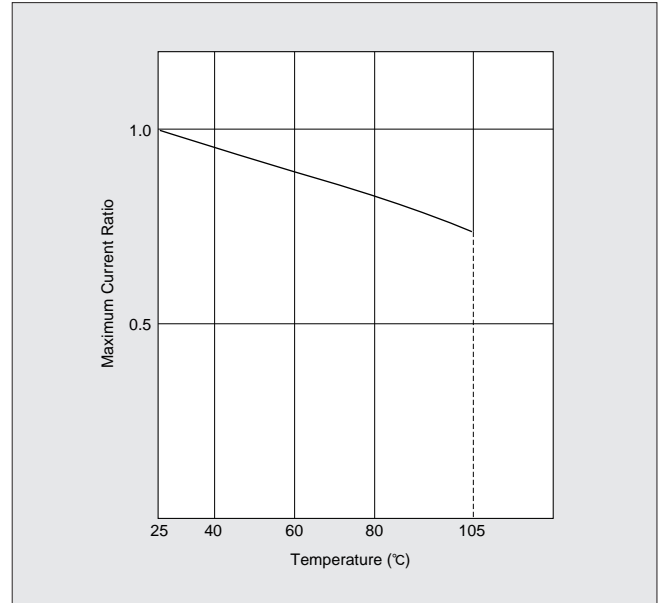

PRECAUTION

1. The product is designed for switching regulators with smoothing capacitors. Other application of the product may result to catching fire in the worst case.
2. Use the product within the specified maximum current. Otherwise it may catch fire in the worst case.
3. Use the product with smoothing capacitor within the specified maximum capacitance value. Otherwise it may catch fire in the worst case.

NOTICE

1. Do not use the product under dewing condition or in liquid.
2. To keep solderability and characteristics of the product from declining, following storage condition is recommended.
 - (1)Storage condition Temperature: -10 to 40D
Humidity: less than 75% RH
(not dewing condition)
 - (2)Term Please use the product within 3 months after shipment by first-in, first-out stocking system.
 - (3)Handling after After unpackaging of the minimum package, reseal it promptly or store it inside a sealed container agent.
 - unpackaging
 - (4)Place Do not store the product in corrosive gas (SOx, Cl, etc)or under sun-light.
3. When more than one piece of the product are used, connect them in series. Parallel connection must be avoided to prevent fire or destruction of the product.

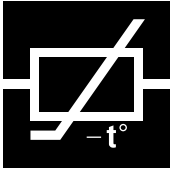

NTC THERMISTOR

muRata

For Inrush Current Suppression **NTH5000** Series

4.The temperature of the product at the maximum current reaches to about 130D.

Pay attention to the surrounding parts or material not to generate any harmful gas which may deteriorate characteristics of the product.

5. Following condition at soldering must be kept in order to avoid deterioration of the product.

(1)Use rosin type flux or non-activated flux.

(2)Flux must not invate in the plastic case of the product.

6. Do not wash the product with water or any solvent.

7. Do not apply an excessive force (more than 24.5N) to the lead.

Otherwise it may cause break off of junction between lead and element, or may crack element.

Therefore, hold the body side lead wire when cutting or bending lead wires.

■ **MINIMUM QUANTITY** (order in sets only)
900pcs

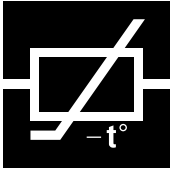

NTC THERMISTOR



Disc Type NTC Thermistor NTH5D Series

Disc Type NTC Thermistor NTH5D Series for Temperature Compensation

The NTH5D series of NTC Thermistor provides a wide range of resistance and B-constant.

This makes them perfect for use in various applications as devices for temperature compensation.

FEATURES

1. Thermally stable with consistent performance.
2. High reliability.

APPLICATIONS

1. Temperature compensation of Transistor, IC circuits.
2. Temperature compensation of measuring equipments and various circuits.
3. Temperature control for home appliances.

PART NUMBERING

(*Please specify the part number when ordering.)

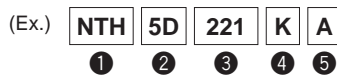

- ① NTC Thermistor
- ② Diameter of element
- ③ Resistance at 25°C (10kΩ : 103)
- ④ Resistance tolerance
- ⑤ Suffix

RATINGS

Part Number	Resistance 25°C(Ω)	B Constant 25/50°C(K)	Resistance Temp.Coeff. (reference value) 25°C(%/°C)
NTH5D221KA	220	3,300	-3.7
NTH5D331KA	330	3,300	-3.7
NTH5D471KA	470	3,500	-3.9
NTH5D681KA	680	3,500	-3.9
NTH5D102KA	1,000	3,800	-4.3
NTH5D152KA	1,500	3,800	-4.3
NTH5D222KA	2,200	3,900	-4.4
NTH5D332KA	3,300	3,900	-4.4
NTH5D472KA	4,700	3,900	-4.4

- B-constant deviation : ±10%
- Rated Electric power : 56mW (25°C, in still air)
- Typical dissipation constant : 5.6mW (25°C, in still air)
- Thermal time constant : 20sec.
- Operating temp.range : -30 to + 125°C

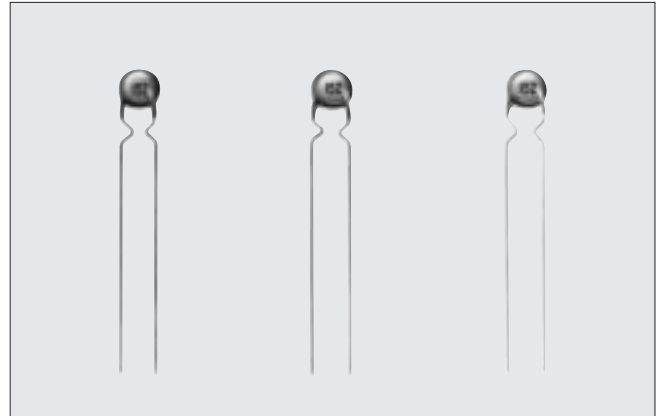

DIMENSIONS

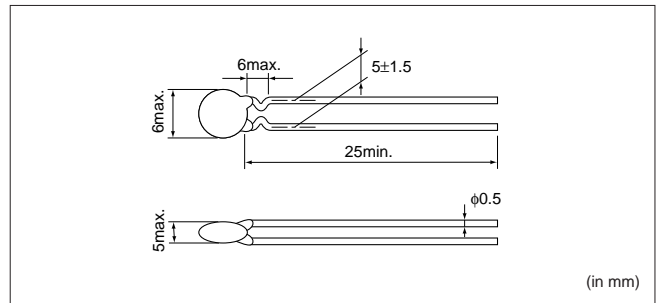

Part Number	Resistance 25°C(Ω)	B Constant 25/50°C(K)	Resistance Temp.Coeff. (reference value) 25°C(%/°C)
NTH5D682KA	6,800	4,100	-4.6
NTH5D103KA	10,000	4,100	-4.6
NTH5D153KA	15,000	4,100	-4.6
NTH5D223KA	22,000	4,200	-4.7
NTH5D333KA	33,000	4,200	-4.7
NTH5D473KA	47,000	4,200	-4.7
NTH5D683KA	68,000	4,400	-4.9
NTH5D104KA	100,000	4,400	-4.9
NTH5D154KA	150,000	4,400	-4.9

⚠ Note:**1. Export Control**

⟨For customers outside Japan⟩

Murata products should not be used or sold for use in the development, production, stockpiling or utilization of any conventional weapons or mass-destructive weapons (nuclear weapons, chemical or biological weapons, or missiles), or any other weapons.

⟨For customers in Japan⟩

For products which are controlled items subject to the "Foreign Exchange and Foreign Trade Law" of Japan, the export license specified by the law is required for export.

2. Please contact our sales representatives or product engineers before using our products listed in this catalog for the applications listed below which require especially high reliability for the prevention of defects which might directly cause damage to the third party's life, body or property, or when intending to use one of our products for other applications than specified in this catalog.

① Aircraft equipment

② Aerospace equipment

③ Undersea equipment

④ Medical equipment

⑤ Transportation equipment (vehicles, trains, ships, etc.)

⑥ Traffic signal equipment

⑦ Disaster prevention / crime prevention equipment

⑧ Data-processing equipment

⑨ Application of similar complexity and/or reliability requirements to the applications listed in the above

3. Product specifications in this catalog are as of Jun 1996. They are subject to change or our products in it may be discontinued without advance notice. Please check with our sales representatives or product engineers before your ordering. If there are any questions, please contact our sales representatives or product engineers.**4. The parts numbers and specifications listed in this catalog are for information only. You are requested to approve our product specification or to transact the approval sheet for product specification, before your ordering.****5. Please note that unless otherwise specified, we shall assume no responsibility whatsoever for any conflict or dispute that may occur in connection with the effect of our and/or third party's intellectual property rights and other related rights in consideration of your using our products and/or information described or contained in our catalogs. In this connection, no representation shall be made to the effect that any third parties are authorized to use the rights mentioned above under licenses without our consent.****6. None of ozone depleting substances (ODS) under the Montreal Protocol is used in manufacturing process of us.**