

## Contents

Features .....	1
Pin Assignment .....	1
Block Diagram .....	1
Instruction Set .....	2
Absolute Maximum Ratings .....	2
Recommended Operating Conditions ...	2
DC Electrical Characteristics .....	3
Rewriting Times .....	3
Pin Capacitance .....	3
AC Electrical Characteristics .....	4
Operation .....	5
Dimensions .....	7
Ordering Informations .....	8
Characteristics .....	9

The S-2900A is a wide operating voltage range, low power consumption 512-bit E<sup>2</sup>PROM. The organization is 64-word × 8-bit, and can be read or written serially. It is easily interfaced with a serial port because the instruction is composed of eight-bit units.

■ Features

- Operating voltage
  - Read : 1.5 to 5.5 V
  - Write : 2.7 to 5.5 V
- Power consumption
  - Standby : 1 μA max.
  - Read : 1.4 mA max. (V<sub>CC</sub> = 5.5 V)
  - 0.4 mA max. (V<sub>CC</sub> = 1.5 V)
- Operating Frequency 2 MHz (V<sub>CC</sub> = 4.5 V to 5.5 V)
- 500 kHz (V<sub>CC</sub> = 2.7 V to 4.5 V)
- 100 kHz (V<sub>CC</sub> = 1.5 V to 2.7 V)
- Memory configuration 512 bits (64-word × 8-bit)
- Byte writing/Byte reading
- Data retention: 10 years
- Package : 8-pin DIP/SOP
  - SOT-89-5
  - Bare chip

■ Pin Assignment

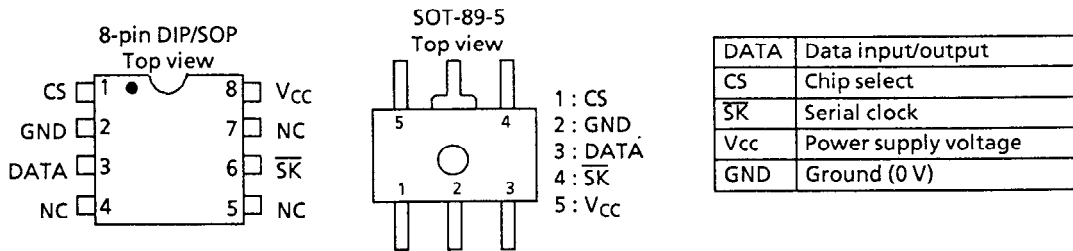

Figure 1

■ Block Diagram

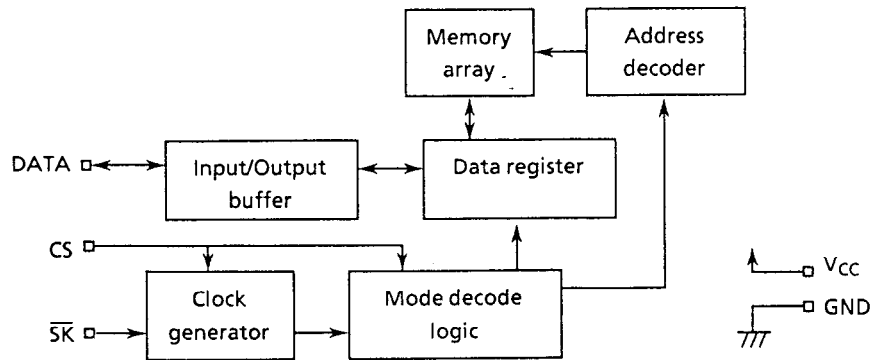

Figure 2

■ Instruction Set

Table 1

Instruction	Op code	Address	Data
READ (Read data)	10	A <sub>5</sub> to A <sub>0</sub>	D <sub>7</sub> to D <sub>0</sub> output
PROGRAM (Program)	01	A <sub>5</sub> to A <sub>0</sub>	D <sub>7</sub> to D <sub>0</sub> input
PEN (Program enable)	00	000000	—
STRD (Status read)	11	111111	output

■ Absolute Maximum Ratings

Table 2

Parameter	Symbol	Ratings	Unit
Power supply voltage	V <sub>CC</sub>	-0.3 to +7.0	V
Input voltage	V <sub>IN</sub>	-0.3 to V <sub>CC</sub> + 0.3	V
Output voltage	V <sub>OUT</sub>	-0.3 to V <sub>CC</sub>	V
Storage temperature under bias	T <sub>bias</sub>	-50 to +95	°C
Storage temperature	T <sub>stg</sub>	-65 to +150	°C

■ Recommended Operating Conditions

Table 3

Parameter	Symbol	Conditions	— Min.	Typ.	Max.	Unit
Power supply voltage	V <sub>CC</sub>	Read	1.5	—	5.5	V
		Write	2.7	—	5.5	V
High level input voltage	V <sub>IH</sub>	V <sub>CC</sub> = 2.7 to 5.5 V	0.8 × V <sub>CC</sub>	—	V <sub>CC</sub>	V
		V <sub>CC</sub> = 1.5 to 2.7 V	0.85 × V <sub>CC</sub>	—	V <sub>CC</sub>	V
Low level input voltage	V <sub>IL</sub>	V <sub>CC</sub> = 2.7 to 5.5 V	0.0	—	0.2 × V <sub>CC</sub>	V
		V <sub>CC</sub> = 1.5 to 2.7 V	0.0	—	0.15 × V <sub>CC</sub>	V
Operating temperature	T <sub>opr</sub>		-40	—	+85	°C

■ DC Electrical Characteristics

Table 4

(Ta = -40°C to 85°C)

Parameter	Smb1	Conditions	Read/Write operations						Read operation			Unit
			V <sub>CC</sub> = 5.0 V ± 10 %			V <sub>CC</sub> = 3 V ± 10 %			V <sub>CC</sub> = 1.5 to 2.7 V			
			Min.	Typ.	Max.	Min.	Typ.	Max.	Min.	Typ.	Max.	
Current consumption (READ)	I <sub>CC1</sub>	DO unloaded	—	—	1.4	—	—	0.7	—	—	0.4	mA
Current consumption (PROGRAM)	I <sub>CC2</sub>	D <sub>O</sub> unloaded	—	—	3.0	—	—	1.0	—	—	—	mA

Table 5

(Ta = -40°C to 85°C)

Parameter	Smb1	Conditions	Read/Write operations						Read operation			Unit
			V <sub>CC</sub> = 5.0 V ± 10 %			V <sub>CC</sub> = 2.7 to 4.5 V			V <sub>CC</sub> = 1.5 to 2.7 V			
			Min.	Typ.	Max.	Min.	Typ.	Max.	Min.	Typ.	Max.	
Standby current consumption	I <sub>SB</sub>	Input: V <sub>CC</sub> or GND	—	—	1.0	—	—	1.0	—	—	1.0	μA
Input leakage current	I <sub>LI</sub>	V <sub>IN</sub> = GND to V <sub>CC</sub>	—	0.1	1.0	—	0.1	1.0	—	0.1	1.0	μA
Output leakage current	I <sub>LO</sub>	V <sub>OUT</sub> = GND to V <sub>CC</sub>	—	0.1	1.0	—	0.1	1.0	—	0.1	1.0	μA
Low level output voltage	V <sub>OL</sub>	CMOS I <sub>OL</sub> = 100 μA	—	—	0.1	—	—	0.1	—	—	0.1	V
		TTL I <sub>OL</sub> = 2.1 mA	—	—	0.45	—	—	—	—	—	—	V
High level output voltage	V <sub>OH</sub>	CMOS V <sub>CC</sub> = 2.7 to 5.5 V: I <sub>OH</sub> = -100 μA V <sub>CC</sub> = 1.5 to 2.7 V: I <sub>OH</sub> = -10 μA	V <sub>CC</sub> -0.7	—	—	V <sub>CC</sub> -0.7	—	—	V <sub>CC</sub> -0.3	—	—	V
		TTL, I <sub>OH</sub> = -400 μA	2.4	—	—	—	—	—	—	—	—	V

■ Rewriting Times

Table 6

(Ta = -40°C to +85°C)

Parameter	Symbol	Min.	Typ.	Max.	Unit
Rewriting times	N <sub>W</sub>	10 <sup>5</sup>	—	—	times/word

■ Pin Capacitance

Table 7

(Ta = 25°C, f = 1.0 MHz, V<sub>CC</sub> = 5 V)

Parameter	Symbol	Conditions	Min.	Typ.	Max.	Unit
Input capacitance	C <sub>IN</sub>	V <sub>IN</sub> = 0 V	—	—	8	pF
Input/Output capacitance	C <sub>I/O</sub>	V <sub>I/O</sub> = 0 V	—	—	10	pF

■ AC Electrical Characteristics

Table 8 Measuring conditions

Input voltage level	$0.1 \times V_{CC}$ to $0.9 \times V_{CC}$
Output voltage level	$0.5 \times V_{CC}$
Output load	100 pF

Table 9

(Ta = -40°C to 85°C)

Parameter	Symbol	Read / Write operations						Read operations			Unit
		$V_{CC} = 5.0 \text{ V} \pm 10\%$			$V_{CC} = 2.7 \text{ to } 4.5 \text{ V}$			$V_{CC} = 1.5 \text{ to } 2.7 \text{ V}$			
		Min.	Typ.	Max.	Min.	Typ.	Max.	Min.	Typ.	Max.	
CS setup time	$t_{CSS}$	0.2	—	—	1.0	—	—	2.0	—	—	$\mu\text{s}$
CS hold time	$t_{CSH}$	0.2	—	—	1.0	—	—	2.0	—	—	$\mu\text{s}$
CS deselect time	$t_{CDS}$	0.2	—	—	0.2	—	—	1.0	—	—	$\mu\text{s}$
Data setup time	$t_{DS}$	0.25	—	—	1.0	—	—	2.0	—	—	$\mu\text{s}$
Data hold time	$t_{DH}$	0.25	—	—	1.0	—	—	2.0	—	—	$\mu\text{s}$
1 data output delay	$t_{PD1}$	—	—	0.4	—	—	1.0	—	—	8.0	$\mu\text{s}$
0 data output delay	$t_{PD0}$	—	—	0.4	—	—	1.0	—	—	8.0	$\mu\text{s}$
Clock frequency	$f_{SK}$	0.0	—	2.0	0.0	—	0.5	0.0	—	0.1	MHz
Clock pulse width	$t_{SKH}, t_{SKL}$	0.25	—	—	1.0	—	—	5.0	—	—	$\mu\text{s}$
Output disable time	$t_{HZ1}, t_{HZ2}$	0	50	200	0	—	1000	0	—	2000	ns
Program time	$t_{PR}$	—	4.0	10	—	4.0	10	—	—	—	ms

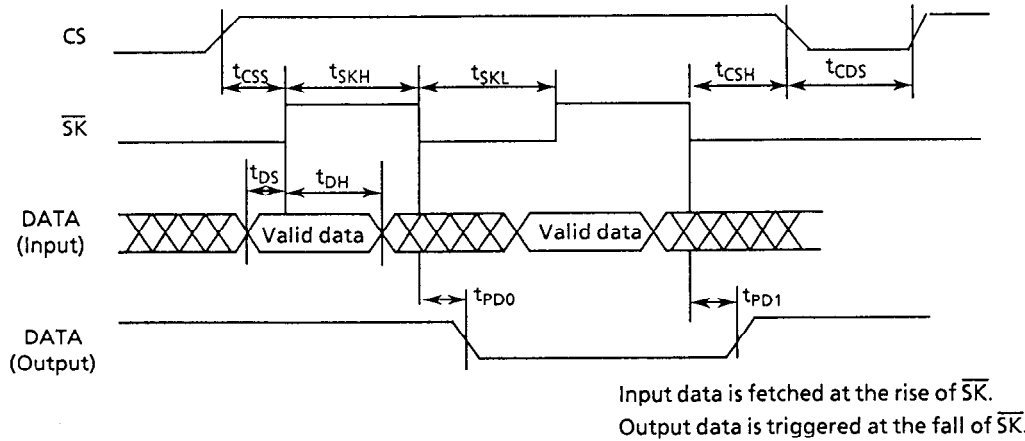

Figure 3 Timing chart

■ Operation

(1) Read (READ) mode

After changing CS from "L" to "H", this mode inputs the op code and address into DATA, synchronized with the rise of  $\overline{SK}$ . When A0 is input at the rise of the eighth  $\overline{SK}$  clock cycle, eight-bit data in the specified address is output from the DATA pin, synchronized with the falling of  $\overline{SK}$ .

The DATA pin changes to high impedance after CS changes to "L".

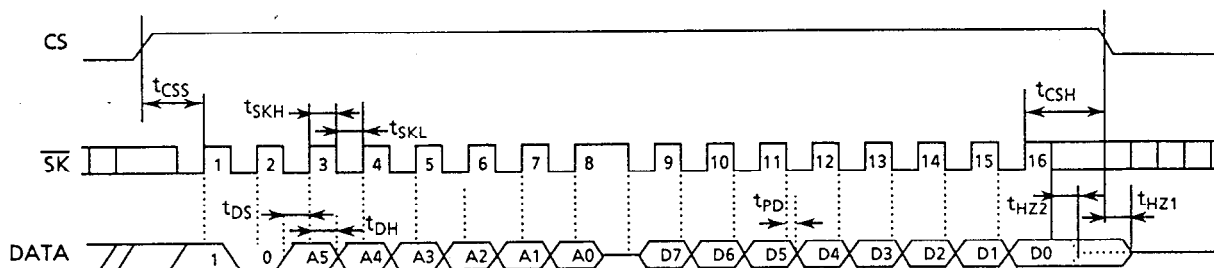

Figure 4

(2) Write (PROGRAM) mode

After changing CS from "L" to "H", this mode inputs the op code, address, and data (eight-bit) into DATA, synchronized with the rise of  $\overline{SK}$ . After data is input, by changing CS from "H" to "L" again, data is written to the chip (the write operation). The write operation time is decided by the timer inside of the IC (10 ms max.).

After the write operation, The S-2900A is automatically in program disable mode. Therefore, the S-2900A must be in program enable mode through executing the PEN instruction before the write operation.

For confirming completion of the write operation, check the status read mode described later.

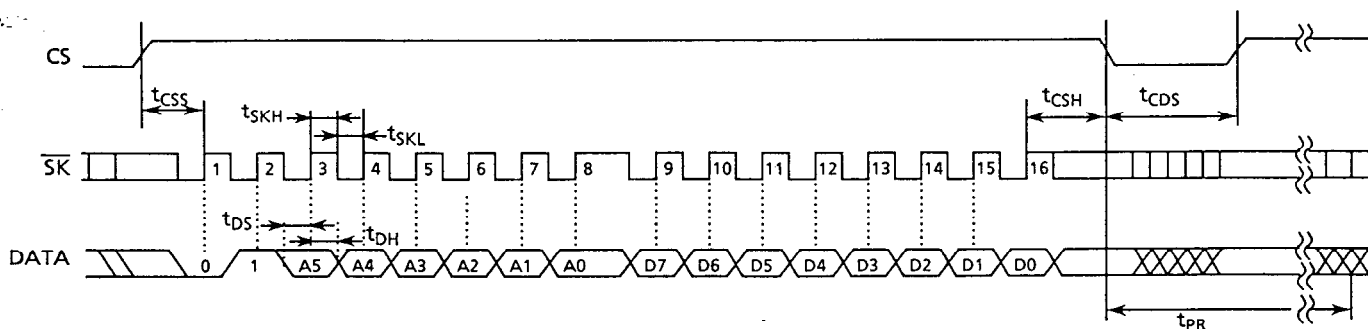

Figure 5

(3) Program enable (PEN) mode

After being in program enable mode through executing the PEN instruction, data can be written (programmed). Before executing a program instruction, the PEN instruction must be executed.

After changing CS from "L" to "H", this mode inputs the op code and address "00H" into DATA, synchronized with the rise of  $\overline{SK}$ . When instruction is received at the rise of the eighth  $\overline{SK}$  clock cycle, the S-2900A is in program enable mode.

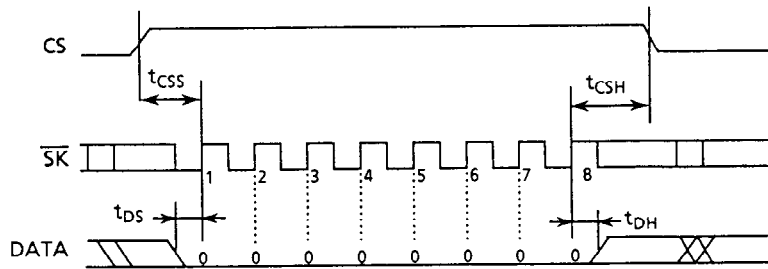

Figure 6

(4) Status read (STRD) mode

STRD confirms whether or not the write operation has been completed. During the write (Busy) operation, low level is output from DATA, and after completing the write operation (Ready status), high level is output.

After changing CS from "L" to "H", this mode inputs the op code and address "3FH" into DATA, synchronized with the rise of  $\overline{SK}$ . From the falling edge of the eighth  $\overline{SK}$  clock cycle, the S-2900A outputs the write operation status.

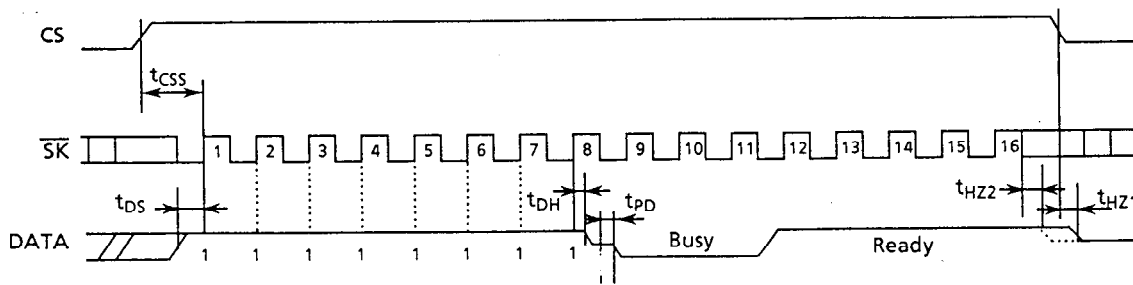

Figure 7

■ Dimensions (Unit:mm)

1. 8-pin DIP

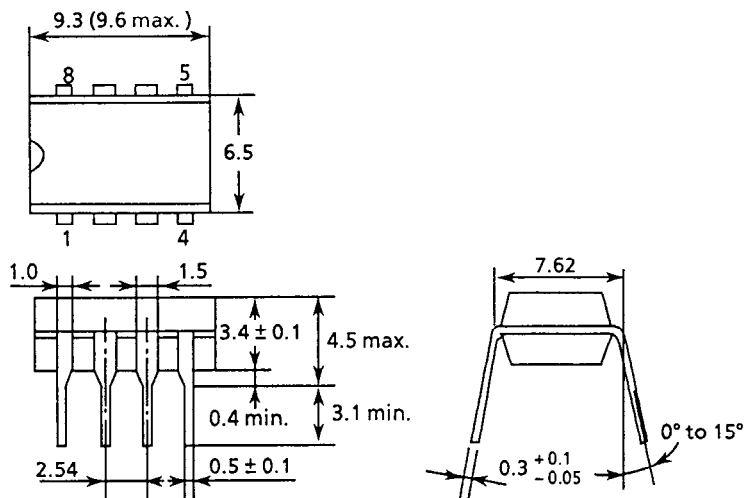

Figure 8

2. 8-pin SOP

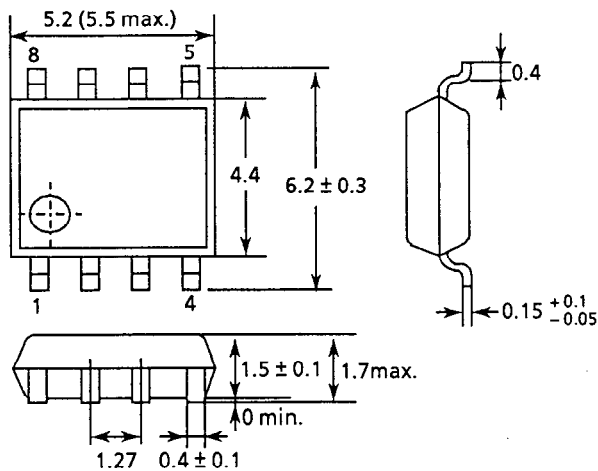

Figure 9



3. SOT-89-5

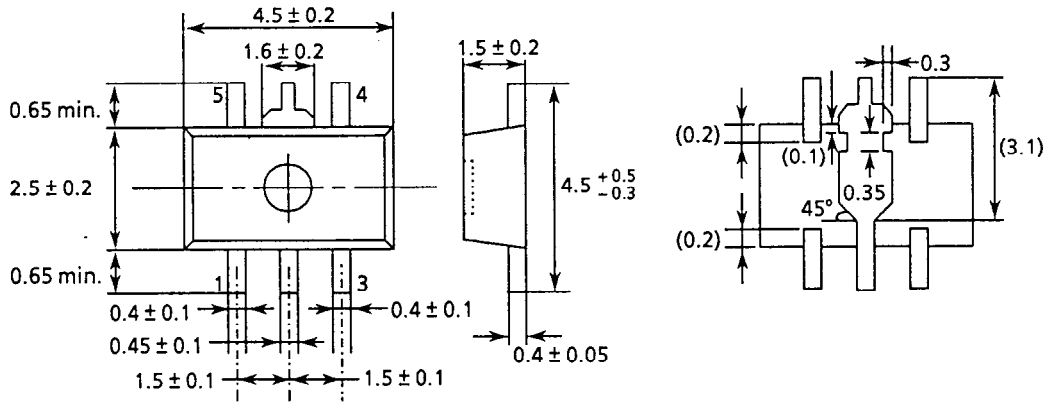
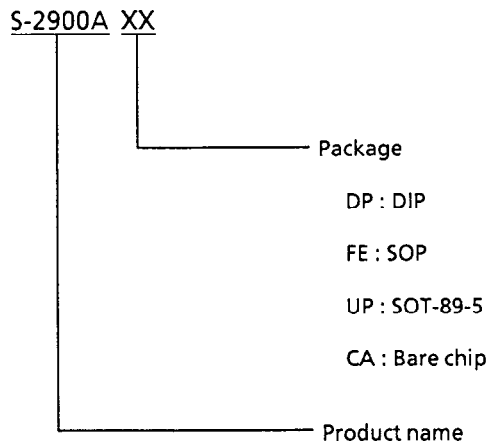

Figure 10

■ Ordering Information



Note : Each bit is set to 1 before delivery (except bare chip) .

■ Characteristics

1. DC characteristics

1.1 Current consumption (READ)  $I_{CC1}$  – Ambient temperature  $T_a$

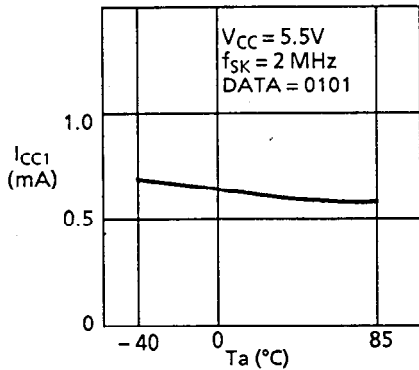

1.2 Current consumption (READ)  $I_{CC1}$  – Ambient temperature  $T_a$

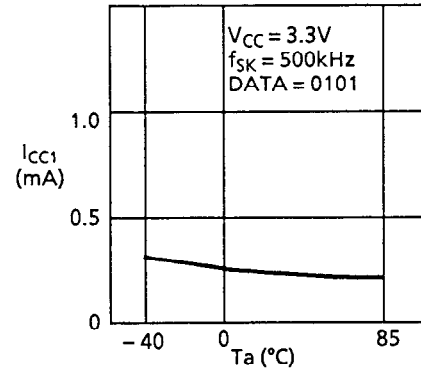

1.3 Current consumption (READ)  $I_{CC1}$  – Power supply voltage  $V_{CC}$

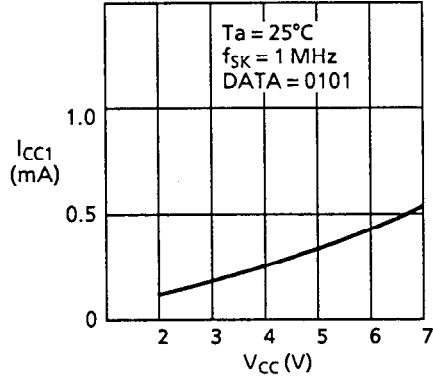

1.4 Current consumption (READ)  $I_{CC1}$  – Clock frequency  $f_{SK}$

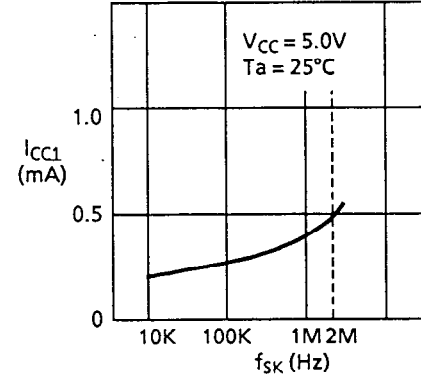

1.5 Current consumption (PROGRAM)  $I_{CC2}$  – Ambient temperature  $T_a$

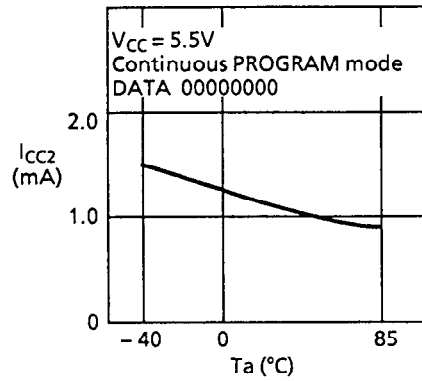

1.6 Current consumption (PROGRAM)  $I_{CC2}$  – Ambient temperature  $T_a$

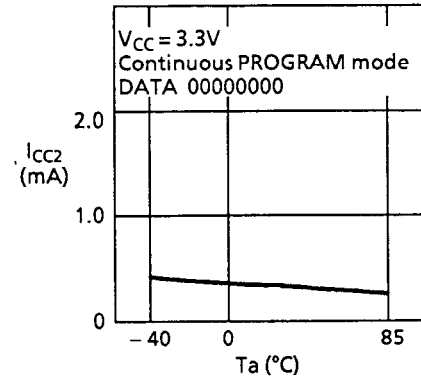

1.7 Current consumption (PROGRAM)  $I_{CC2}$  – Power supply voltage  $V_{CC}$

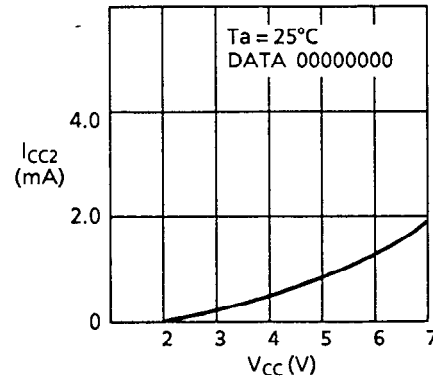

1.8 Standby current consumption  $I_{SB}$  – Ambient temperature  $T_a$

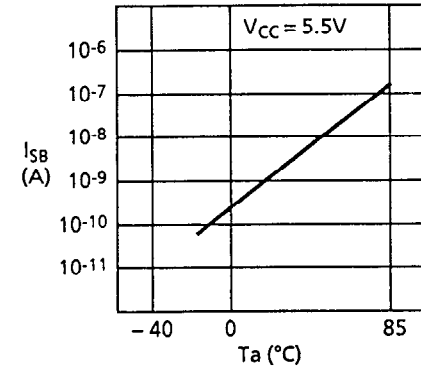

1.9 Input leakage current  $I_{LI}$  – Ambient temperature  $T_a$

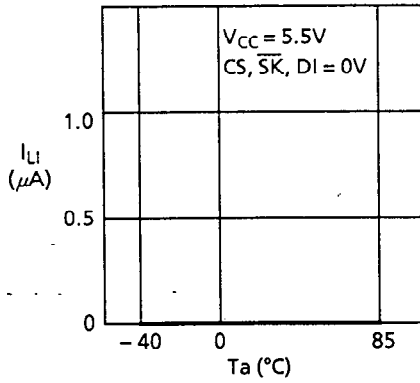

1.10 Input leakage current  $I_{LI}$  – Ambient temperature  $T_a$

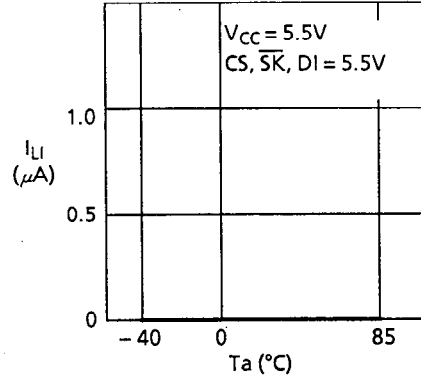

1.11 Output leakage current  $I_{LO}$  – Ambient temperature  $T_a$

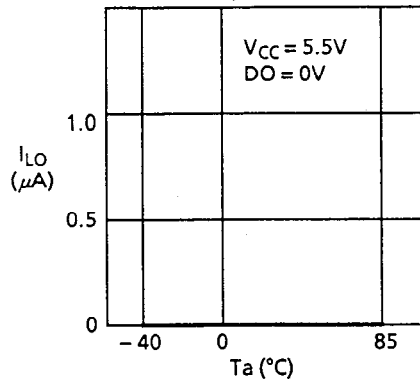

1.12 Output leakage current  $I_{LO}$  – Ambient temperature  $T_a$

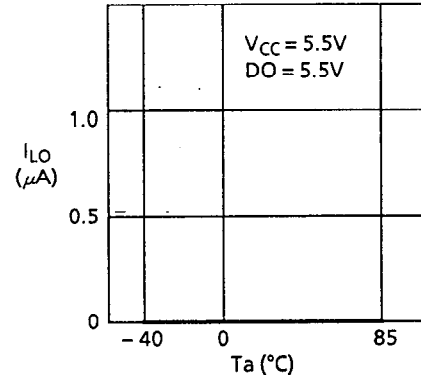

1.13 High level output voltage  $V_{OH}$  – Ambient temperature  $T_a$

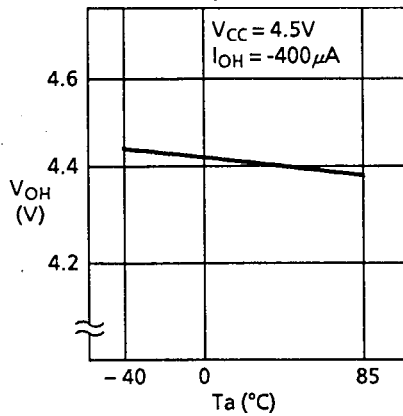

1.14 High level output voltage  $V_{OH}$  – Ambient temperature  $T_a$

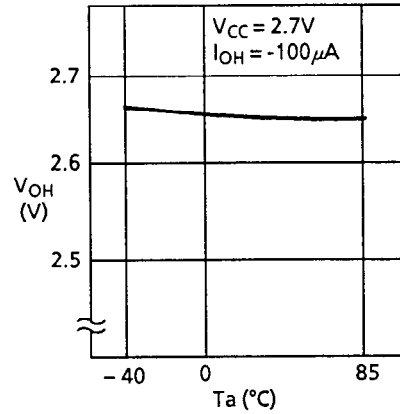

1.15 Low level output voltage  $V_{OL}$  – Ambient temperature  $T_a$

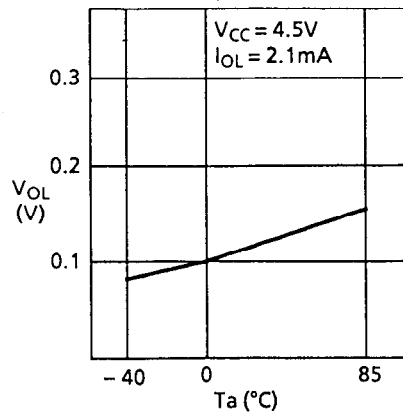

1.16 Low level output voltage  $V_{OL}$  – Ambient temperature  $T_a$

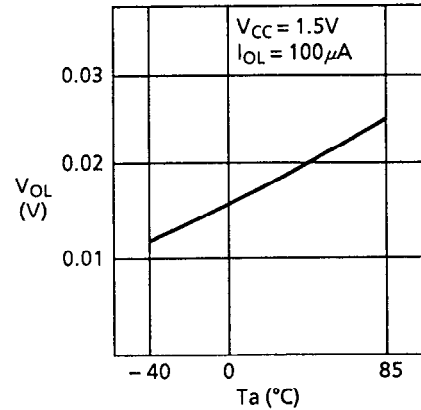

1.17 High level output current  $I_{OH}$  – Ambient temperature  $T_a$

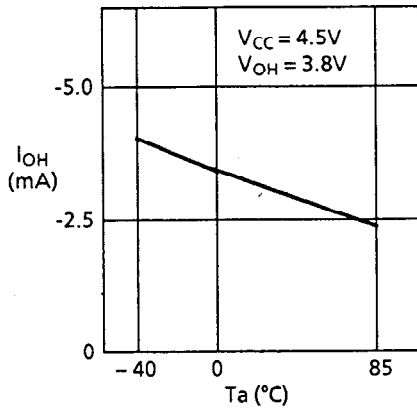

1.18 High level output current  $I_{OH}$  – Ambient temperature  $T_a$

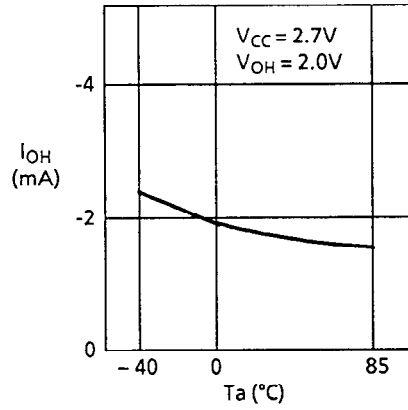

1.19 Low level output current  $I_{OL}$  – Ambient temperature  $T_a$

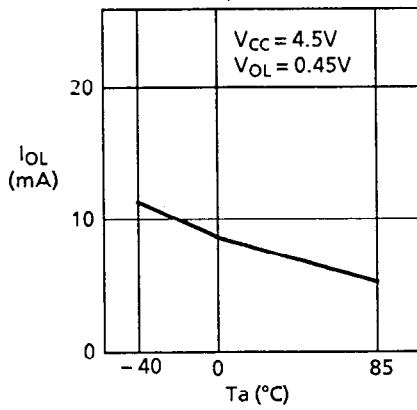

1.20 Low level output current  $I_{OL}$  – Ambient temperature  $T_a$

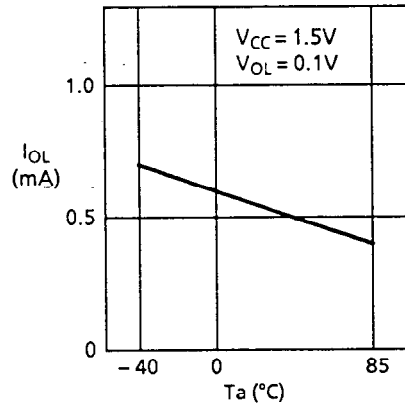

1.21 Input reversal voltage  $V_{INV}$  – Power supply voltage  $V_{CC}$

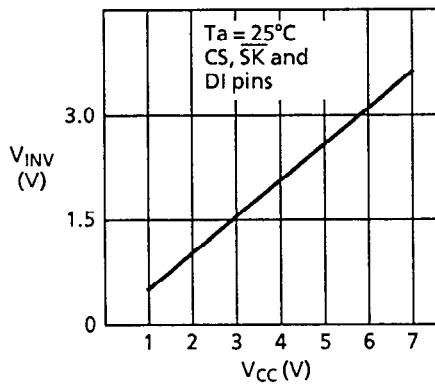

1.22 Input reversal voltage  $V_{INV}$  – Ambient temperature  $T_a$

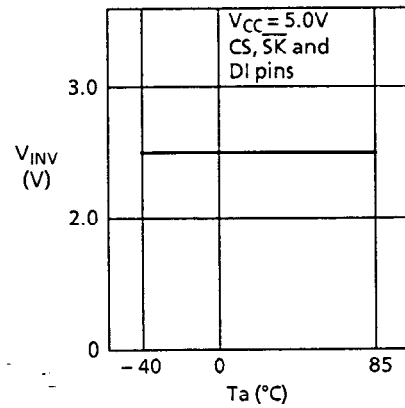

2. AC characteristics

2.1 Maximum operating frequency  $f_{max}$  – Power supply voltage  $V_{CC}$

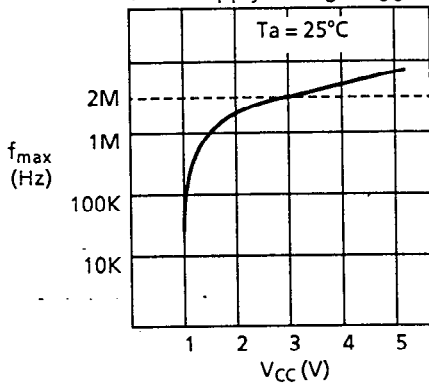

2.2 Program time  $t_{PR}$  – Power supply voltage  $V_{CC}$

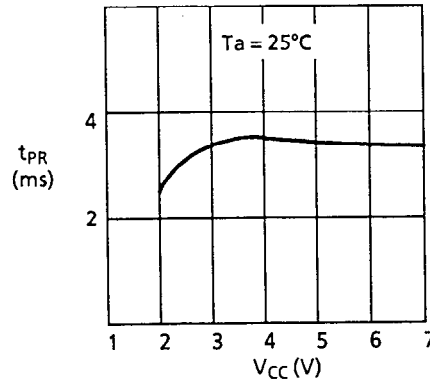

2.3 Program time  $t_{PR}$  – Ambient temperature  $T_a$

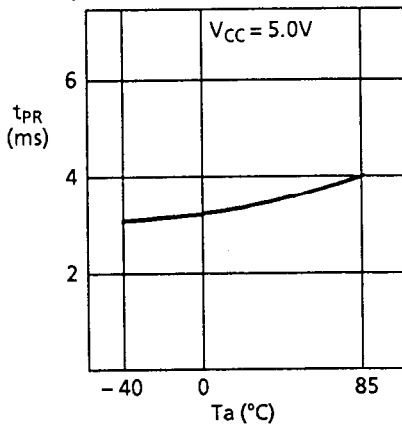

2.4 Program time  $t_{PR}$  – Ambient temperature  $T_a$

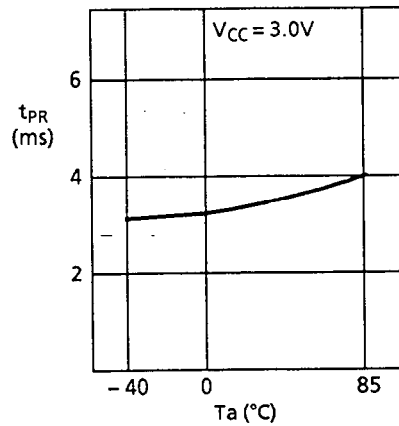

2.5.1 data output delay time  $t_{PD1}$  – Ambient temperature  $T_a$

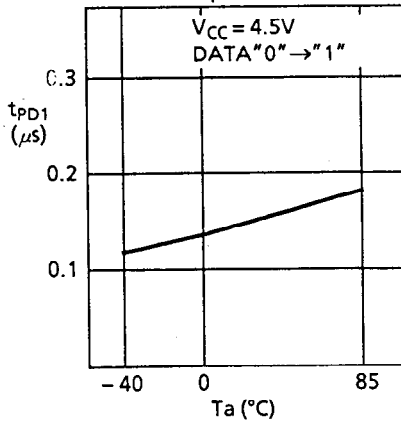

2.6.1 data output delay time  $t_{PD1}$  – Ambient temperature  $T_a$

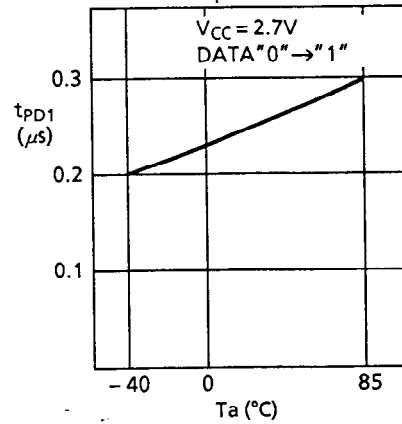

2.7.0 data output delay time  $t_{PD0}$  – Ambient temperature  $T_a$

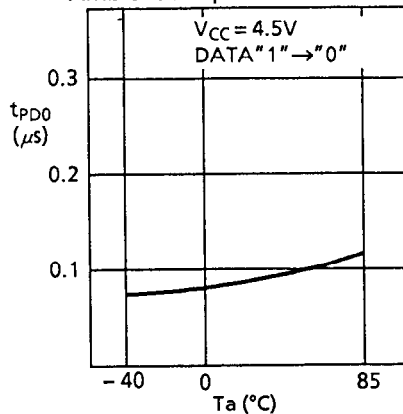

2.8.0 data output delay time  $t_{PD0}$  – Ambient temperature  $T_a$

