



FP106

TR:PNP Epitaxial Planar Silicon Transistor
SBD:Schottky Barrier Diode

DC-DC Converter Applications

Features

- Complex type with a PNP transistor and a Schottky barrier diode in one package, facilitating high-density mounting.
- The FP106 is composed of 2 chips, one being equivalent to the 2SA1898 and the other the SB10-05C.

Package Dimensions

unit:mm

2088A

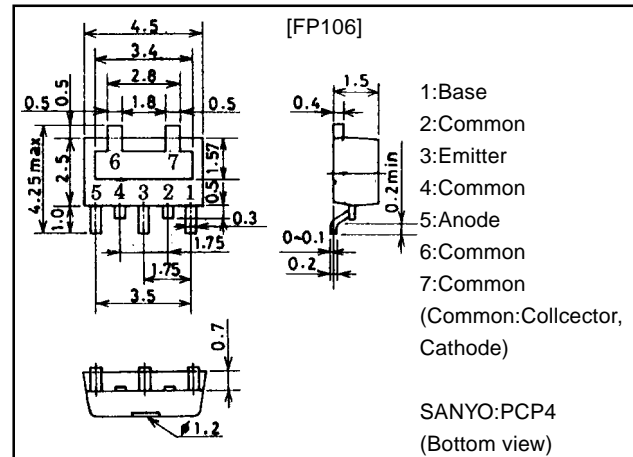

Specifications

Absolute Maximum Ratings at Ta = 25°C

Parameter	Symbol	Conditions	Ratings	Unit
[TR]				
Collector-to-Base Voltage	V_{CBO}		-15	V
Collector-to-Emitter Voltage	V_{CEO}		-15	V
Emitter-to-Base Voltage	V_{EBO}		-5	V
Collector Current	I_C		-3	A
Collector Current (Pulse)	I_{CP}		-5	A
Base Current	I_B		-600	mA
Collector Dissipation	P_C	Mounted on ceramic board (250mm ² ×0.8mm)	1.3	W
Junction Temperature	T_j		150	°C
Storage Temperature	T_{stg}		-55 to +150	°C
[SBD]				
Repetitive Peak Reverse Voltage	V_{RRM}		15	V
Non-repetitive Peak Reverse Surge Voltage	V_{RSM}		17	V
Average Rectified Current	I_O		1	A
Surge Forward Current	I_{FSM}	50Hz sine wave, 1cycle	8	A
Junction Temperature	T_j		-55 to +125	°C
Storage Temperature	T_{stg}		-55 to +125	°C

Marking:106

Continued on next page.

Electrical Connection

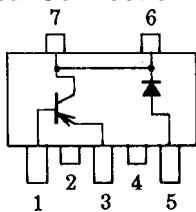

- 1:Base
2:Common
3:Emitter
4:Common
5:Anode
6:Common
7:Common
(Common:Collector, Cathode)

SANYO Electric Co.,Ltd. Semiconductor Business Headquarters

TOKYO OFFICE Tokyo Bldg., 1-10, 1 Chome, Ueno, Taito-ku, TOKYO, 110-8534 JAPAN

FP106

Continued from preceding page.

Electrical Characteristics at Ta=25°C

Parameter	Symbol	Conditions	Ratings			Unit
			min	typ	max	
[TR]						
Collector Cutoff Current	I_{CBO}	$V_{CB}=-12V, I_E=0$			-1	μA
Emitter Cutoff Current	I_{EBO}	$V_{EB}=-3V, I_C=0$			-1	μA
DC Current Gain	h_{FE1}	$V_{CE}=-2V, I_C=-0.5A$	100		280	
	h_{FE2}	$V_{CE}=-2V, I_C=-3A$	50			
Gain-Bandwidth Product	f_T	$V_{CE}=-2V, I_C=-0.3A$		300		MHz
Output Capacitance	C_{ob}	$V_{CE}=-10V, f=1MHz$		28		pF
C-E Saturation Voltage	$V_{CE(sat)}$	$I_C=-1.5A, I_B=-75mA$		-0.25	-0.5	V
B-E Saturation Voltage	$V_{BE(sat)}$	$I_C=-1.5A, I_B=-75mA$		-0.95	-1.2	V
C-B Breakdown Voltage	$V_{(BR)CBO}$	$I_C=-10\mu A, I_E=0$	-15			V
C-E Breakdown Voltage	$V_{(BR)CEO}$	$I_C=-1mA, R_{BE}=\infty$	-15			V
E-B Breakdown Voltage	$V_{(BR)EBO}$	$I_E=-10\mu A, I_C=0$	-5			V
Turn-ON Time	t_{on}	See specified Test Circuit		30		ns
Storage Time	t_{stg}	See specified Test Circuit		100		ns
Fall Time	t_f	See specified Test Circuit		120		ns
[SBD]						
Reverse Voltage	V_R	$I_R=300\mu A$	15			V
Forward Voltage	V_F	$I_F=1A$			0.55	V
Reverse Current	I_R	$V_R=7.5V$			50	μA
Interterminal Capacitance	C	$V_R=10V, f=1MHz$		30		pF
Reverse Recovery Time	t_{rr}	$I_F=I_R=100mA$, See specified Test Circuit			10	ns
Thermal Resistance	R_{thj-a}	Mounted on ceramic board (250mm ² ×0.8mm)		120		°C/W

Switching Time Test Circuit

(TR)

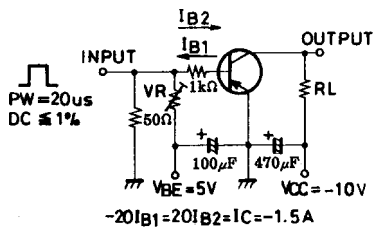

(SBD)

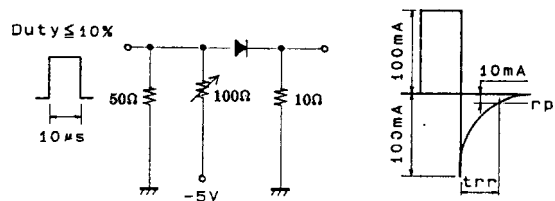

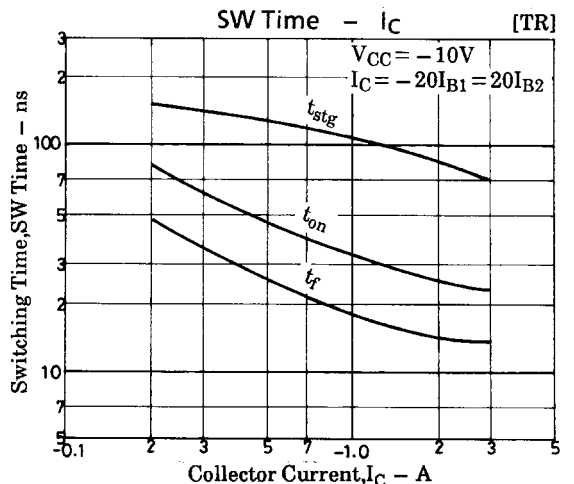
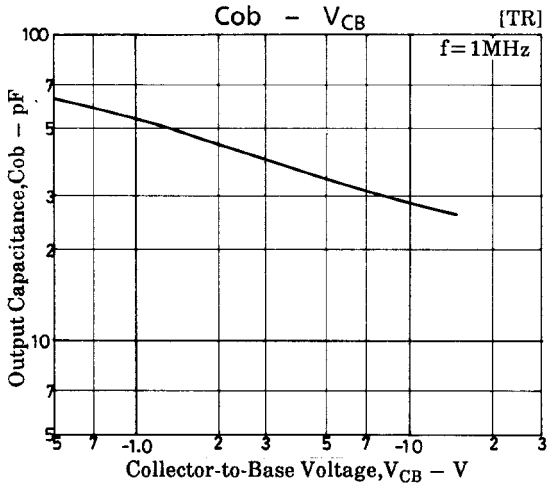
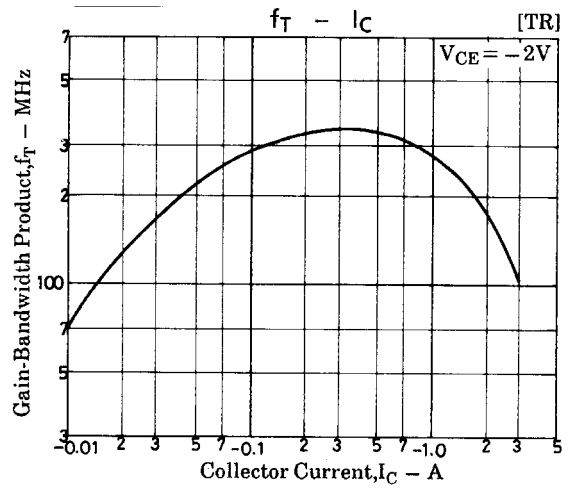
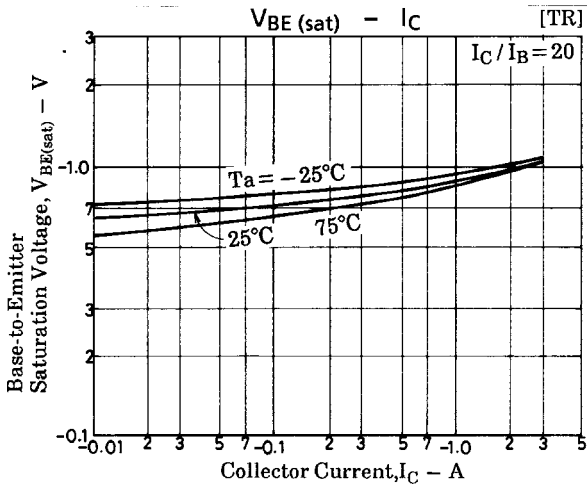
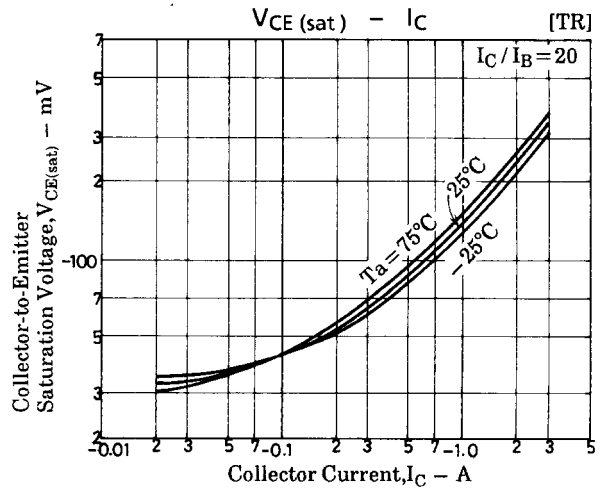
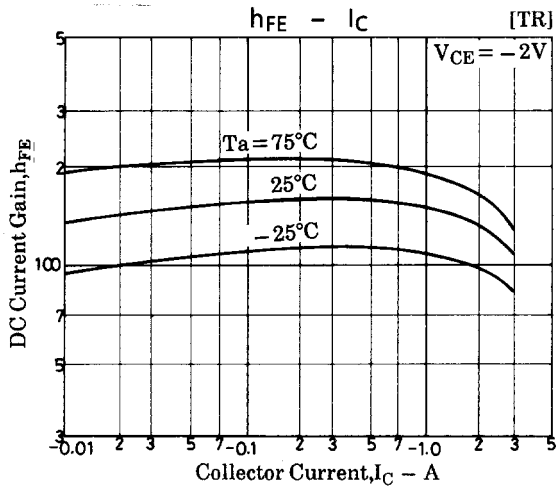
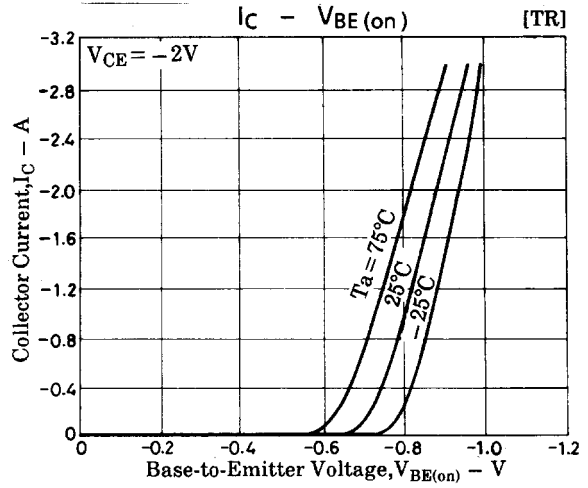
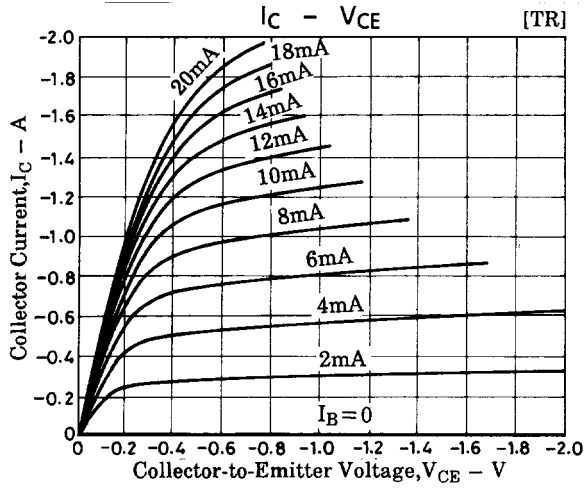

FP106

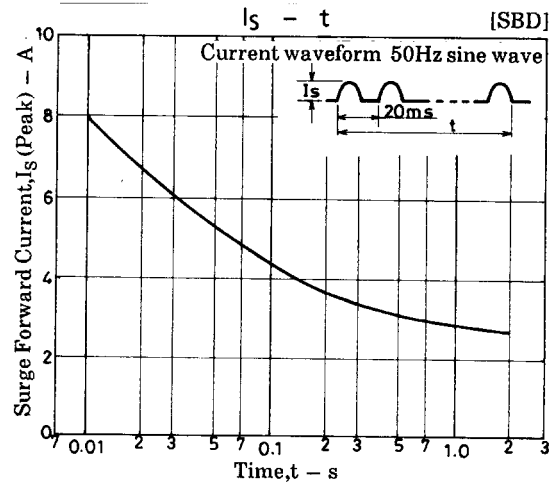
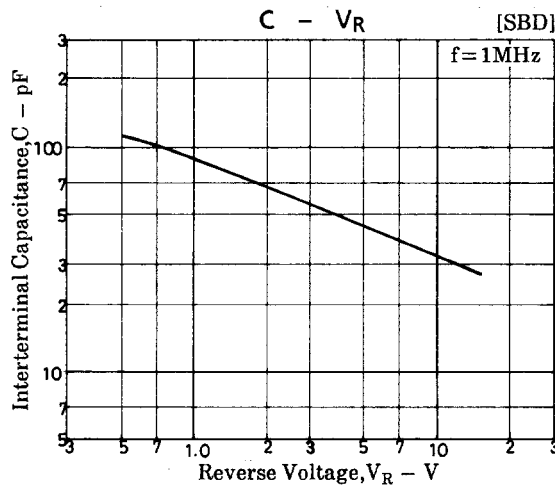
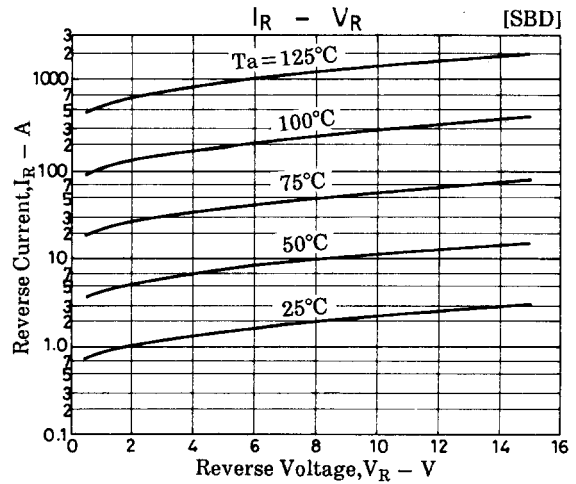
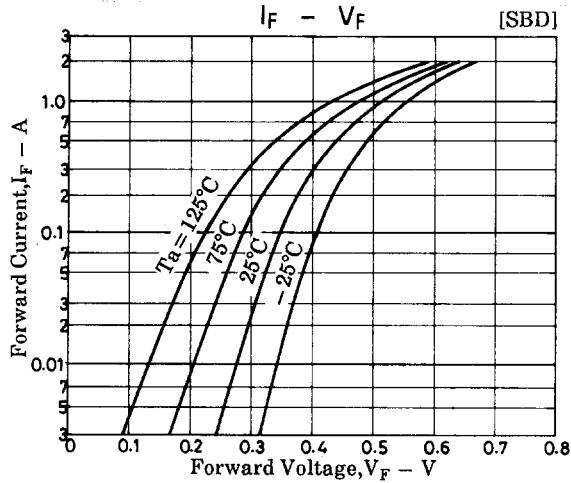
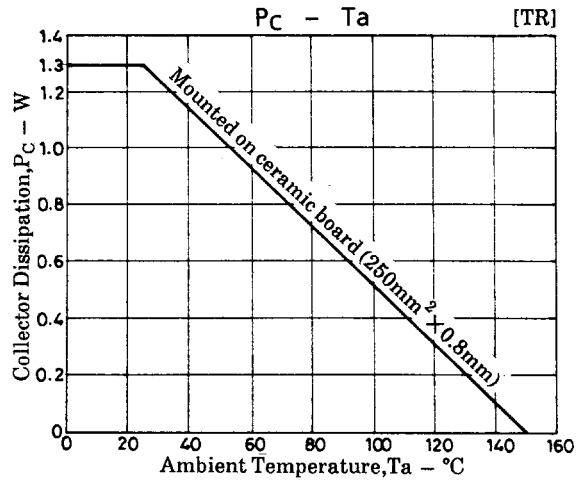
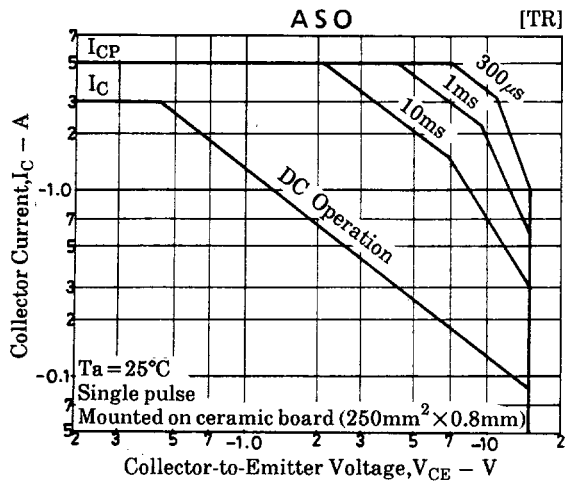

■ No products described or contained herein are intended for use in surgical implants, life-support systems, aerospace equipment, nuclear power control systems, vehicles, disaster/crime-prevention equipment and the like, the failure of which may directly or indirectly cause injury, death or property loss.

■ Anyone purchasing any products described or contained herein for an above-mentioned use shall:

- ① Accept full responsibility and indemnify and defend SANYO ELECTRIC CO., LTD., its affiliates, subsidiaries and distributors and all their officers and employees, jointly and severally, against any and all claims and litigation and all damages, cost and expenses associated with such use:
- ② Not impose any responsibility for any fault or negligence which may be cited in any such claim or litigation on SANYO ELECTRIC CO., LTD., its affiliates, subsidiaries and distributors or any of their officers and employees jointly or severally.

■ Information (including circuit diagrams and circuit parameters) herein is for example only; it is not guaranteed for volume production. SANYO believes information herein is accurate and reliable, but no guarantees are made or implied regarding its use or any infringements of intellectual property rights or other rights of third parties.

This catalog provides information as of May, 1998. Specifications and information herein are subject to change without notice.