

XC6376/6377 Series



PWM Controlled, PWM/PFM Switchable Step - down DC/DC Converters

- ◆ P-Channel Power MOSFET Built-in
- ◆ Maximum Output Current : 500mA
- ◆ Output Voltage Range : 1.5~6.0V
- ◆ Oscillator Frequency : 300kHz
- ◆ Maximum Duty Ratio : 100%
- ◆ High Efficiency : 95%
- ◆ SOP-8 Package

General Description

The XC6376/77 series are step-down DC/DC converters with built-in P-channel power MOSFETs. A highly efficient DC/DC converter with output currents of 500mA can be realised using only four peripherals - a coil, a diode and 2 capacitors.

Output voltage can be internally set-up in 0.1V increments ($\pm 2.5\%$) between 1.5V and 6.0V (V_{OUT} type). Alternatively, output voltage can be set-up at will using a 1.0V internal reference voltage source and peripherals (FB type). It is possible to reduce the size of the peripherals used since the switching frequency is 300kHz.

The PWM/PFM switchable XC6377 operates in PFM mode during light loads and is highly efficient from light loads to large output currents.

Required values for soft start time can be regulated via the external capacitor and the stand-by function reduces supply current to less than 2.5 μ A.

U.V.L.O and protection are built-in.

Applications

- Electronic Information Organizers
- Palmtops
- Cellular and portable phones
- Portable Audio Systems
- Various Multi-function Power Supplies

Features

- Input voltage range** : 1.8V~10V
- Output voltage range** : 1.5V~6.0V programmable in 0.1V steps ($\pm 2.5\%$)
- Oscillator frequency** : 300kHz ($\pm 1.5\%$)
: Custom products for 180, 500kHz
- Max. output current** : 500mA (min.) $V_{IN}=3.6V$, $V_{OUT}=3.0V$
- High Efficiency** : 95% (typ.)
- Stand-by capability** : $I_{STB}=2.5\mu A$ (max.)
- Soft-start time set-up externally type**
- U.V.L.O, Pch boost, V_{OUT} reset functions available**
- Internally set-up output voltage type (V_{OUT})**
- Externally set-up output voltage type (FB)**
- Pchannel Power MOSFET built-in**
- Package** : SOP-8

Typical Application Circuit

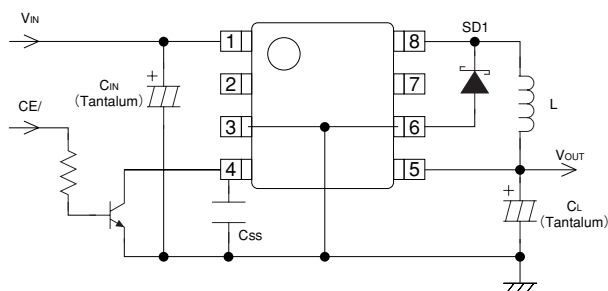

Typical Performance Characteristic

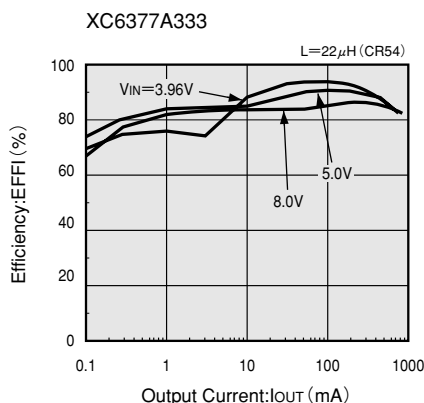

Pin Configuration

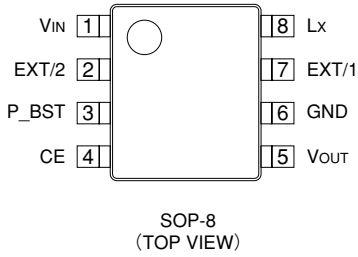

Pin Assignment

PIN NUMBER	PIN NAME	FUNCTION
1	V _{IN}	Power supply input
2	EXT/2	External drive pin 2 ("L" when Pch MOSFET ON)
3	P_BST	P-ch gate boost
4	CE	Chip enable Soft-start capacitor connection
5	V _{OUT} (FB)	Output voltage monitor (FB=externally set-up type)
6	GND	Ground
7	EXT/1	External drive pin 1 ("L" when P-ch MOSFET ON)
8	LX	P-ch power MOSFET switch

5

Product Classification

● Selection Guide

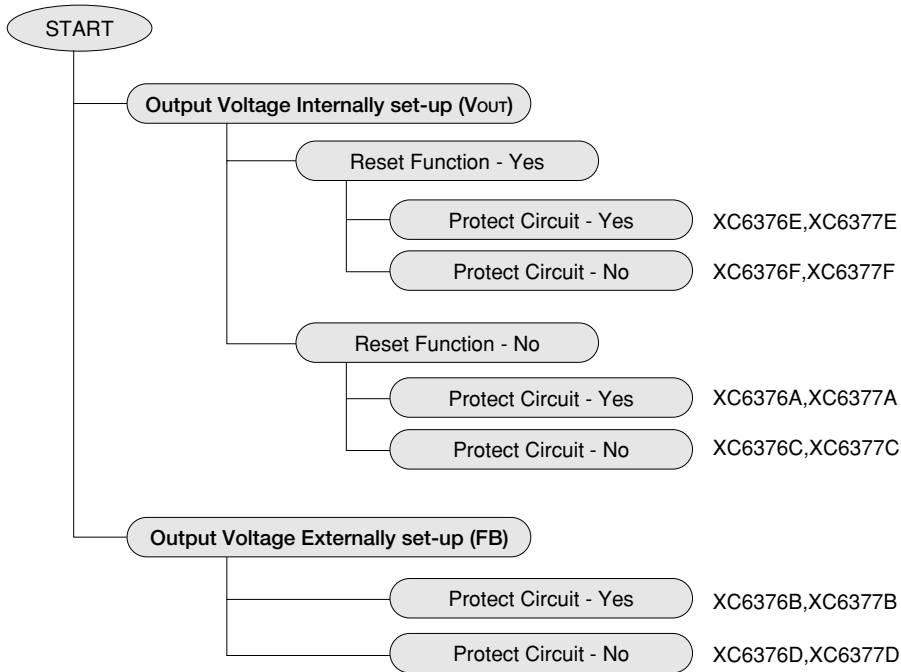

●Ordering Information

XC6376①②③④⑤⑥

XC6376 Series PWM Control

SYMBOL		V _{OUT} /FB	V _{OUT} RESET FUNCTION	INTEGRAL CIRCUIT PROTECTION
①	A	V _{OUT}	NO	YES
	B	FB	-	YES
	C	V _{OUT}	NO	NO
	D	FB	-	NO
	E	V _{OUT}	YES	YES
	F	V _{OUT}	YES	NO
② ③	Output voltage e.g. 3.0V output : (②=3, ③=0) FB products (B,D types) : (②=1, ③=0)			
④	3	Oscillator frequency 300kHz		
	5	Oscillator frequency 500kHz		
	2	Oscillator frequency 180kHz		
⑤	S	Package SOP-8		
⑥	R	Embossed Tape : Standard Feed		
	L	: Reverse Feed		

5

XC6377①②③④⑤⑥

XC6377 Series PWM/PFM switching control
(same as XC6376 series)

■Packaging Information

●SOP-8

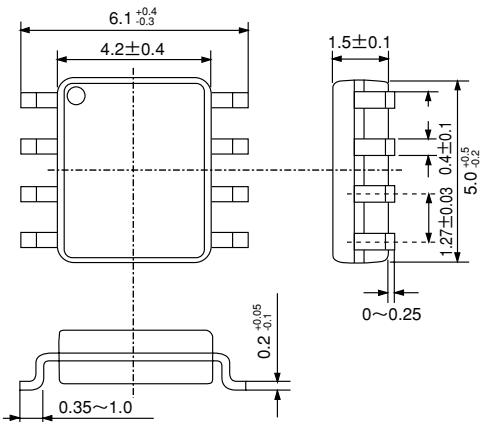

Marking

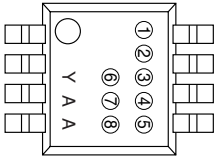

SOP-8
(TOP VIEW)

①②③④⑤⑥⑦⑧

EX : XC6376A303SR

LOGO MARK		7	6	A	3	0	3
①	②	③	④	⑤	⑥	⑦	⑧

MarkY : Year code

Represents the single digit of Dominical Year

MarkAA: Assembly Lot

Denotes the production lot number 0 to 9, A to Z repeated(G.I.I.O.Q.W excepted)

Higher order zero is not represented.

Block Diagram

XC6376, XC6377 Series A,C types (Vout)

5

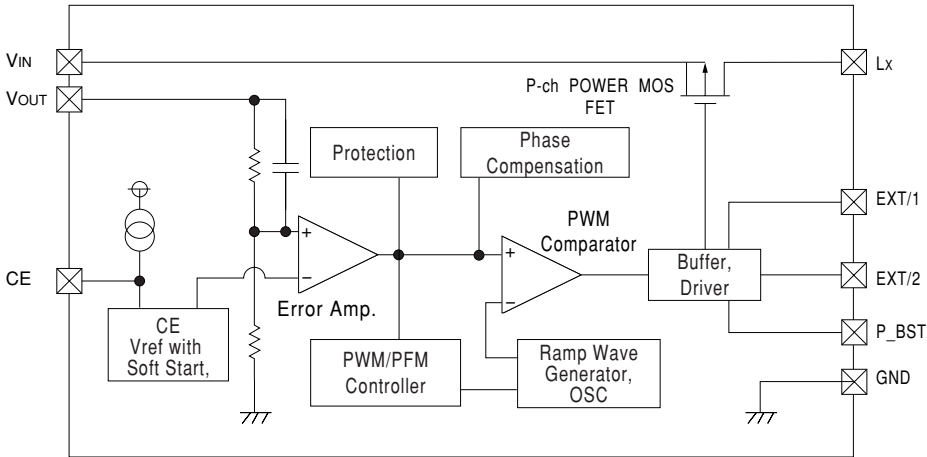

XC6376, XC6377 Series B,D types (FB)

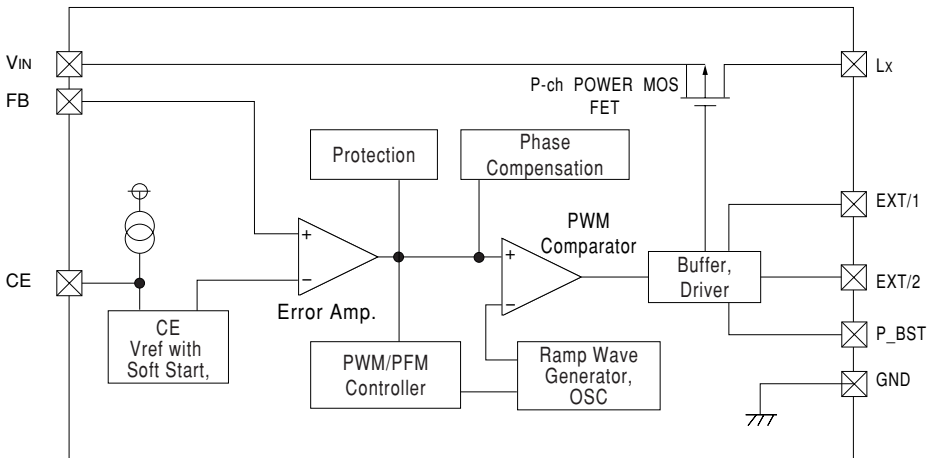

XC6376, XC6377 Series E,F types (V_{OUT}, V_{OUT} rest function)

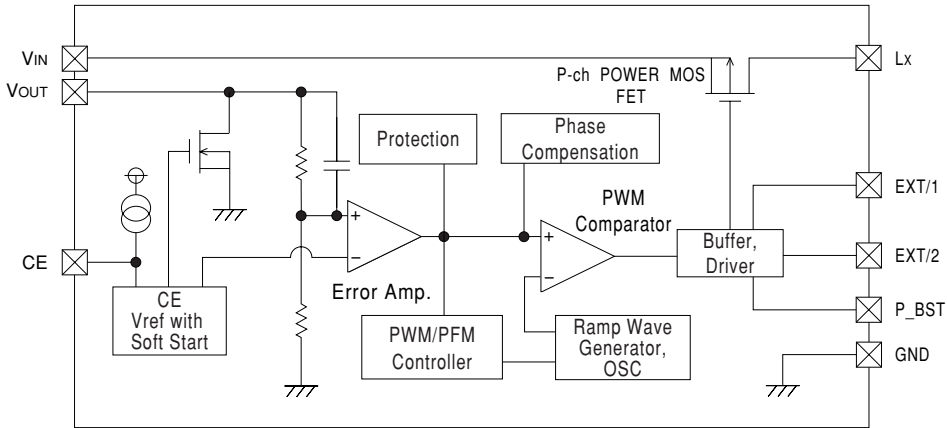

Absolute Maximum Ratings

T_a=25°C

PARAMETER	SYMBOL	RATINGS	UNITS
V _{IN} Pin Voltage	V _{IN}	-0.3 ~ 12	V
V _{OUT} Pin Voltage (FB Pin Voltage)	V _{OUT} (V _{FB})	-0.3 ~ 12 (-0.3 ~ V _{IN} +0.3)	V
L _x Pin Voltage	V _{LX}	V _{IN} -12 ~ V _{IN} +0.3	V
P_BST Pin Voltage	P_BST	V _{IN} -12 ~ V _{IN} +0.3	V
Other Pin Voltage	V~	-0.3 ~ V _{IN} +0.3	V
L _x Pin Current	I _{LX}	700	mA
EXT/1,2 Pin Current	I _{EXT/1,2}	±50	mA
Continuous Total Power Dissipation	P _d	300	mW
Operating Ambient Temperature	T _{opr}	-30 ~ +80	°C
Storage Temperature	T _{stg}	-40 ~ +125	°C

Electrical Characteristics

XC6376A333SR, XC6377A333SR

(V_{OUT}=3.3V, F_{OSC}=300kHz)

T_a=25°C

PARAMETER	SYMBOL	CONDITIONS	MIN	TYP	MAX	UNITS
Output Voltage	V _{OUT1}	External components connected, V _{IN} =output programmed voltage x 1.2, I _{OUT} =132mA	3.218	3.300	3.383	V
Output Voltage2	V _{OUT2}	External components connected, V _{IN} =output programmed voltage x 1.6, (when V _{IN} ≤ 3.0V, V _{IN} =3.0V)	V _{OUT1} -0.5%		V _{OUT1} +1.5%	V
Maximum Input Voltage	V _{IN}		10			V
Maximum Output Current	I _{OUTMAX}	External components connected, V _{IN} =output programmed voltage x 1.2,	600			mA
Input Current	I _{IN}	External components connected, XC6376		1.480	2.190	mA
		V _{IN} =V _{OUT} x 1.05, No load. XC6377		55	86	μA
Supply Current (oscillation stopped)	I _{DD}	Only C _{SS} connected, V _{IN} = output programmed voltage x 1.2, V _{OUT} = V _{IN} , V _{LX} =V _{IN}		26	39	μA
Stand-by Current	I _{STB}	Same as I _{DD} . CE=0V		1.5	2.5	μA
Lx SW ON Resistance	R _{SWON}	Same as I _{DD} except V _{OUT} =output programmed voltage x0.9, V _{LX} =V _{IN} -0.2V, pull down LX to 10Ω, CE=V _{IN}		0.64	0.85	Ω
Lx Leak Current	I _{LXL}	Same as I _{STB} except V _{LX} =0V			2.0	μA
Oscillator Frequency (Note1)	F _{OSC}	External components connected, measuring of EXT/1 waveform, V _{IN} =V _{OUT1} +0.3V, I _{OUT} =20mA	255	300	345	kHz
Maximum Duty Ratio	MAXDTY		100			%
PFM Duty Ratio (Note2)	PFMDTY	External components connected, No load.	15	25	35	%
Efficiency (Note3)	EFFI	Same as V _{OUT} 1		95		%
Minimum Operating Voltage (UVLO Voltage)	V _{UVLO}	Only C _{SS} connected, V _{IN} = output programmed voltage x 0.9, CE= V _{IN} , LX OFF voltage when V _{IN} drops.	0.9		1.8	V
Soft-Start Time	T _{SS}		6.0	10.0	16.0	msec
Circuit Protect Integration Time	T _{PRO}	Only C _{SS} connected, V _{IN} = output programmed voltage x 1.2, Time taken for CE to become "L" when V _{OUT} changes to 0V	3.0	5.0	8.0	msec
CE "High" Voltage	V _{CEH}	Only C _{SS} connected, V _{IN} = output programmed voltage x 1.2, V _{OUT} =0V, Apply voltage to CE and measure EXT/1,2 "L"	0.65			V
CE "Low" Voltage	V _{CEL}	Only C _{SS} connected, V _{IN} = output programmed voltage x 1.2, V _{OUT} =0V, Apply voltage to CE and measure EXT/1,2 "H"			0.20	V
EXT/1,2 "H" ON Resistance	R _{EXTBH}	Only C _{SS} connected, V _{IN} = output programmed voltage x 1.2, CE=0V, V _{OUT} =V _{IN} , EXT/1,2 pull down to 200Ω, V _{EXT/1,2} =V _{IN} - 0.4V		35	47	Ω
EXT/1,2 "L" ON Resistance	R _{EXTBL}	Only C _{SS} connected, V _{IN} = output programmed voltage x 1.2, CE=V _{IN} , V _{OUT} =output programmed voltage x 0.9, EXT/1,2 pull up to 200Ω, V _{EXT/1,2} =0.4V		29	37	Ω

Note 1: Refers to the oscillation frequency during PWM control.

Note 2: Applies to the XC6377 series only (duty ratio when control changes to PFM)

Note 3: EFFI = { [(output voltage) x (output current)] ÷ [(input voltage) x (input current)] } x100

XC6376E, XC6376F, XC6377E, XC6377F

The following parameter is to be added:

PARAMETER	SYMBOL	CONDITIONS	MIN	TYP	MAX	UNITS
V _{OUT} Sink Current	I _{VOUTL}	Same as I _{STB} , V _{OUT} =1.0V	1.45			mA

XC6376C, XC6376F, XC6377C, XC6377F

The following parameter is to be excluded: Circuit Protect Integration Time (T_{PRO})

XC6376A503SR, XC6377A503SR

(V_{OUT}=5.0V, F_{OSC}=300kHz)

T_a=25°C

PARAMETER	SYMBOL	CONDITIONS	MIN	TYP	MAX	UNITS	
Output Voltage	V _{OUT1}	External components connected, V _{IN} =output programmed voltage x 1.2, I _{OUT} =200mA	4.875	5.000	5.125	V	
Output Voltage2	V _{OUT2}	External components connected, V _{IN} =output programmed voltage x 1.6, (when V _{IN} ≤ 3.0V, V _{IN} =3.0V)	V _{OUT1} -0.5%		V _{OUT1} +1.5%	V	
Maximum Input Voltage	V _{IN}		10			V	
Maximum Output Current	I _{OUTMAX}	External components connected, V _{IN} =output programmed voltage x 1.2,	600			mA	
Input Current	I _{IN}	External components connected, V _{IN} =V _{OUT} x 1.05, No load.	XC6376		2.540	3.740	mA
			XC6377		71	110	µA
Supply Current (oscillation stopped)	I _{DD}	Only C _{SS} connected, V _{IN} = output programmed voltage x 1.2, V _{OUT} = V _{IN} , V _{LX} =V _{IN}		26	39	µA	
Stand-by Current	I _{STB}	Same as I _{DD} . CE=0V		1.5	2.5	µA	
Lx SW ON Resistance	R _{SWON}	Same as I _{DD} except V _{OUT} =output programmed voltage x 0.9, V _{LX} =V _{IN} -0.2V, pull down LX to 10Ω, CE=V _{IN}		0.44	0.58	Ω	
Lx Leak Current	I _{LXL}	Same as I _{STB} except V _{LX} =0V			2.0	µA	
Oscillator Frequency (Note1)	F _{OSC}	External components connected, measuring of EXT/1 waveform, V _{IN} =V _{OUT1} +0.3V, I _{OUT} =20mA	255	300	345	kHz	
Maximum Duty Ratio	MAXDTY		100			%	
PFM Duty Ratio (Note2)	PFMDTY	External components connected, No load.	15	25	35	%	
Efficiency (Note3)	EFFI	Same as V _{OUT} 1		95		%	
Minimum Operating Voltage (UVLO Voltage)	V _{UVLO}	Only C _{SS} connected, V _{IN} = output programmed voltage x 0.9, CE= V _{IN} , LX OFF voltage when V _{IN} drops.	0.9		1.8	V	
Soft-Start Time	T _{SS}		6.0	10.0	16.0	msec	
Circuit Protect Integration Time	T _{PRO}	Only C _{SS} connected, V _{IN} = output programmed voltage x 1.2, Time taken for CE to become "L" when V _{OUT} changes to 0V	3.0	5.0	8.0	msec	
CE "High" Voltage	V _{CEH}	Only C _{SS} connected, V _{IN} = output programmed voltage x 1.2, V _{OUT} =0V, Apply voltage to CE and measure EXT/1,2 "L"	0.65			V	
CE "Low" Voltage	V _{CEL}	Only C _{SS} connected, V _{IN} = output programmed voltage x 1.2, V _{OUT} =0V, Apply voltage to CE and measure EXT/1,2 "H"			0.20	V	
EXT/1,2 "H" ON Resistance	R _{EXTBH}	Only C _{SS} connected, V _{IN} = output programmed voltage x 1.2, CE=0V, V _{OUT} =V _{IN} , EXT/1,2 pull down to 200Ω, V _{EXT/1,2} =V _{IN} - 0.4V		24	32	Ω	
EXT/1,2 "L" ON Resistance	R _{EXTBL}	Only C _{SS} connected, V _{IN} = output programmed voltage x 1.2, CE=V _{IN} , V _{OUT} =output programmed voltage x 0.9, EXT/1,2 pull up to 200Ω, V _{EXT/1,2} =0.4V		20	26	Ω	

Note 1: Refers to the oscillation frequency during PWM control.
 Note 2: Applies to the XC6377 series only (duty ratio when control changes to PFM)
 Note 3: EFFI = { [(output voltage) x (output current)] ÷ [(input voltage) x (input current)] } x100

XC6376E, XC6376F, XC6377E, XC6377F

The following parameter is to be added:

PARAMETER	SYMBOL	CONDITIONS	MIN	TYP	MAX	UNITS
V _{OUT} Sink Current	I _{VOUTL}	Same as I _{STB} , V _{OUT} =1.0V	1.85			mA

XC6376C, XC6376F, XC6377C, XC6377F

The following parameter is to be excluded: Circuit Protect Integration Time (T_{PRO})

5

XC6376B103SR, XC6377B103SR

(V_{OUT}=3.0V(when programmed), F_{OSC}=300kHz)

T_a=25°C

PARAMETER	SYMBOL	CONDITIONS	MIN	TYP	MAX	UNITS	
Output Voltage	V _{OUT1}	External components connected, V _{IN} =3.6V, I _{OUT} =120mA	2.940	3.000	3.060	V	
Output Voltage2	V _{OUT2}	External components connected, V _{IN} =4.8V	V _{OUT1} -0.5%		V _{OUT1} +1.5%	V	
Maximum Input Voltage	V _{IN}		10			V	
Maximum Output Current	I _{OUTMAX}	External components connected, V _{IN} =3.6V	500			mA	
Input Current	I _{IN}	External components connected, V _{IN} =V _{OUT} x 1.05, No load.	XC6376		1.320	1.950	mA
			XC6377		52	82	μA
Supply Current (oscillation stopped)	I _{DD}	Only C _{SS} connected, V _{IN} = 3.6V FB= 1.2V, V _{LX} =V _{IN}		26	39	μA	
Stand-by Current	I _{STB}	Same as I _{DD} . CE=0V		1.5	2.5	μA	
Lx SW ON Resistance	R _{SWON}	Only C _{SS} connected, V _{IN} =3.6V, CE=V _{IN} , LX pull down to 10Ω V _{LX} =V _{IN} - 0.2V, FB=0.9V		0.69	0.94	Ω	
Lx Leak Current	I _{LXL}	Same as I _{STB} except V _{LX} =0V			2.0	μA	
Oscillator Frequency (Note1)	F _{OSC}	External components connected, measuring of EXT/1 waveform, V _{IN} =V _{OUT1} +0.3V, I _{OUT} =20mA	255	300	345	kHz	
Maximum Duty Ratio	MAXDTY		100			%	
PFM Duty Ratio (Note2)	PFMDTY	External components connected, No load.	15	25	35	%	
Efficiency (Note3)	EFFI	Same as V _{OUT} 1		95		%	
Minimum Operating Voltage (UVLO Voltage)	V _{UVLO}	Only C _{SS} connected. CE= V _{IN} , FB=0.9V, LX OFF voltage when V _{IN} drops.	0.9		1.8	V	
Soft-Start Time	T _{SS}		6.0	10.0	16.0	msec	
Circuit Protect Integration Time	T _{PRO}	Only C _{SS} connected, V _{IN} = 3.6V Time taken for CE to become "L" when V _{OUT} changes to 0V	3.0	5.0	8.0	msec	
CE "High" Voltage	V _{CEH}	Only C _{SS} connected, V _{IN} = 3.6V, FB=0V, Apply voltage to CE and measure EXT/1,2 "L"	0.65			V	
CE "Low" Voltage	V _{CEL}	Only C _{SS} connected, V _{IN} = 3.6V, FB=0V, Apply voltage to CE and measure EXT/1,2 "H"			0.20	V	
EXT/1,2 "H" ON Resistance	R _{EXTBH}	Only C _{SS} connected, CE=0V, V _{IN} =3.6V, FB=1.2V, EXT/1,2 pull down to 200Ω, V _{EXT/1,2} =V _{IN} - 0.4V		38	52	Ω	
EXT/1,2 "L" ON Resistance	R _{EXTBL}	Only C _{SS} connected, CE=V _{IN} , V _{IN} =3.6V, FB=0.9V, EXT/1,2 pull up to 200Ω, V _{EXT/1,2} =0.4V		31	41	Ω	

Peripherals: R_{Fb1}=400kΩ, R_{Fb2}=200kΩ, C_{Fb}=100pF

Note 1: Refers to the oscillation frequency during PWM control.

Note 2: Applies to the XC6377 series only (duty ratio when control changes to PFM)

Note 3: EFFI = { [(output voltage) x (output current)] ÷ [(input voltage) x (input current)] } x100

XC6376D, XC6376D

The following parameter is to be excluded: Circuit Protect Integration Time (T_{PRO})

Typical Application Circuits

1. Output Voltage Internally Set-up Type (V_{OUT})

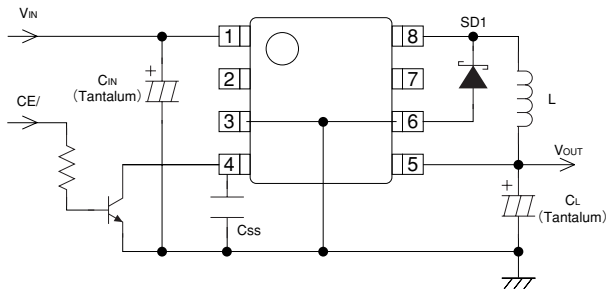

External Components :

- L : 22 μ H (Sumida CR54, Fosc=300kHz)
47 μ H (Sumida CR75, Fosc=180kHz)
10 μ H (Sumida CR54, Fosc=500kHz)
- SD1 : MA2Q735 (Schottky Diode, Matsushita)
- CL : 10V 47 μ F (Tantalum capacitor, Nichicon MCE)
- CSS : 4700pF (Ceramic capacitor, Fosc=300kHz, 180kHz)
0.01 μ F (Ceramic capacitor, Fosc=500kHz)
- CIN : 16V 10 μ F (Tantalum capacitor, Nichicon MCE)

Note : Please increase capacitance value (C_{IN}) when necessary

2. Output Voltage Externally Set-up Type (FB)

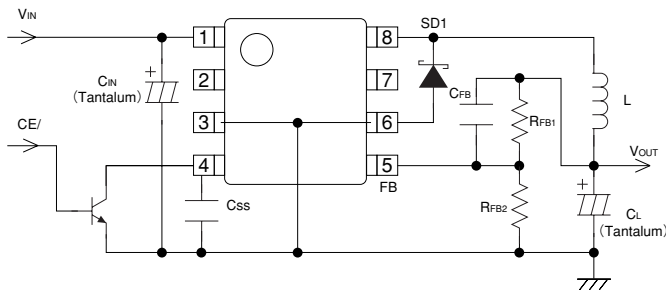

External Components :

- L : 22 μ H (Sumida CR54, Fosc=300kHz)
47 μ H (Sumida CR75, Fosc=180kHz)
10 μ H (Sumida CR54, Fosc=500kHz)
- SD1 : MA2Q735 (Schottky Diode, Matsushita)
- CL : 10V 47 μ F (Tantalum capacitor, Nichicon MCE)
- CSS : 4700pF (Ceramic capacitor, Fosc=300kHz, 180kHz)
0.01 μ F (Ceramic capacitor, Fosc=500kHz)
- CIN : 16V 10 μ F (Tantalum capacitor, Nichicon MCE)
- RFB : Please set-up so that $R_{FB1} \div R_{FB2} = V_{OUT} - 1$ (V_{OUT} = set-up output voltage) and ensure that $R_{FB1} + R_{FB2} \leq 2M\Omega$. N.B. In actual operation please set-up so that the FB pin will be equal to 1.0V
- C_{FB} : Please set-up so that $\{ f = 1 \div (2\pi \times C_{FB} \times R_{FB1}) \}$ will be in the range of 1 ~ 20kHz (5kHz normal)
e.g. If $V_{OUT} = 3.0V$ then $R_{FB1} = 400k\Omega$, $R_{FB2} = 200k\Omega$, $C_{FB} = 100pF$

Note : Please increase capacitance value (C_{IN}) when necessary

Directions for use

Notes

1. Maximum Output Current I_{OUTMAX}

The maximum output current of a step-down DC/DC converter can be calculated from the values of the switching transistor's ON resistance (R_{SWON}), the DC resistance of the coil (DCR) and the wiring resistance between the input and output pins (RETC).

$$I_{OUTMAX} = (V_{IN} - V_{OUT}) / (R_{SWON} + DCR + RETC)$$

The coil's DCR value will be 0.18Ω(max.) with the CR54 22μH (catalog value).

If output current should exceed the above calculated value for I_{OUTMAX} a condition of maximum duty will exist.

Please use coils and Schottky diodes that have an ample output current (I_{OUT}) margin over the stated approved currents and check the coil's current frequency in actual operation.

2. Board Wiring

Peripherals should be located as close as possible to the IC and should be connected with low impedance traces.

Note that high current levels flow through the V_{IN} - IC - coil - V_{OUT} line. Make the ground pattern as large as possible and connect capacitor C_L between the ground pin and the V_{OUT} pin with a low impedance.

3. Integral Circuit Protection

Should the output voltage drop as a result of overload, the IC will operate in a maximum duty state. If the TPRO time (5 msec typ.) is exceeded the CE pin will be reset to ground level and the soft-start routine will resume.

If the overload condition continues then the following steps will be repeated.

Circuit protection activates - CE pin reset - soft-start routine resumes - circuit protection activates - etc.

As stated, when the current drawn exceeds the maximum output current (I_{OUTMAX}) as calculated above, maximum duty will exist. When the input/output voltage differential is minimal even a comparatively small output current will trigger the protection circuit so please be careful.

For those customers who require the P-channel power MOSFET to be enabled at any time and the protect circuit to not operate during low V_{IN} periods, versions of the series without protection are also available (XC6376C, D, F types and XC6377C, D, F types)

Note :

Integral circuit protection performs the basic function of informing external components of the existence of a continuous state of overload in connection with temporary drops in the level of V_{OUT} (CE). Therefore, should output short to ground level and a state of overload continue, ample circuit protection cannot be provided. In such cases, as there is the possibility that the IC and/or the peripherals may be damaged, it is recommended that output be switched off via the CE pin.

4. Soft-start, Chip Enable Circuits (CE Pin)

In order to charge the soft-start capacitor (C_{SS}) at the CE pin, a fixed current of about 1μA has been internally set-up. Therefore, when using the CE function (stand-by operations) please be aware of the possibilities of leak current from the transistor's open collector (or open drain) connection. We recommend that a capacitor of at least 100pF be connected. Although the IC will still function with C_{SS} omitted and the CE pin connected to the V_{IN} pin, there exists the possibility that large overshoot input voltages and/or rush currents will occur when the power is switched on which may cause instability.

The same problem may also arise if the CE pin is driven from a CMOS output, so it is recommended that the CE pin be driven from an open collector (or open drain). Should the CE pin be driven from a CMOS output however, a resistor should be fitted between the CE pin and the output and a soft-start capacitor (C_{SS}) should be connected. Measuring operational stability is also necessary.

Note :

Even if the CE function is not being used, a soft-start capacitor (C_{SS}) of more than 100pF should still be connected.

5. P-Channel Boost Circuit

Attaching a capacitor (C_{BST}) and a diode (SD2) as displayed in the figure right, allows the gate voltage of an internal P-ch power MOSFET to be driven to a negative voltage value.

Since L_X SW ON resistance (R_{SWON}) becomes smaller, the efficiency at high output currents can be improved. On the other hand, efficiency during light loads will drop due to losses as a result of C_{BST}'s charging and discharging.

C_{BST} : 2200pF (ceramic capacitor)

SD2 : MA729 (Schottky diode, Matsushita)

Note :

The voltage between V_{IN} and P-BST should not exceed 10V (absolute max. 12V).

With higher V_{IN} values, take such countermeasures as clamping or using a 9V Zener diode.

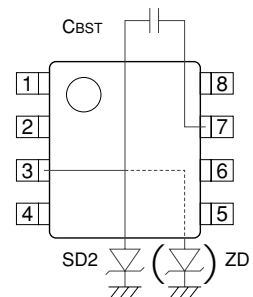

6. EXT / 1, EXT / 2 Pins

As the EXT / 1 and EXT / 2 pins are provided, external transistor drives and various application circuits can be handled.

EXT / 1 follows the same timing pattern as a P-channel power MOSFET ("L" in the ON mode) whereas EXT / 2 functions in a 100 nsec blank clock timing pattern (N.B. EXT / 2 changes from "H to L" 100 nsec before EXT / 1 but 100 nsec after EXT / 1 with "L to H" changes.) e.g.

The drawing of large output currents can be handled by connecting an external, low ON resistance, P-ch power MOSFET.

In such cases we also recommend that the FET gate be connected to EXT / 1, the source to V_{IN} and the drain to Lx in line with the typical application circuit examples provided.

The EXT / 1 pin can be driven to a gate capacitance of up to 1000pF.

7. U. V. L. O Circuit

Below the minimum operating voltage (V_{UVLO}) operations shut down and, along with the P-ch power MOSFET being set to OFF, EXT / 1 and EXT / 2 will be "H" . (If using an external transistor, the transistor will be set to OFF.)

8. V_{OUT} Reset Function

A function that pulls V_{OUT} to ground during stand-by (CE "L") is available (XC6376E).

Note that this function is not available with externally set-up output voltage types (FB).

9. Capacitor C_{IN}

Sudden current changes at ground or power supply that are common to step-down DC/DC converters during switching may cause the IC's operations to become unstable depending upon the degree to which the IC's power supply voltage changes, which in turn is affected by the wiring's impedance level.

It is therefore recommended that a power supply ripple rejection use capacitor (C_{IN}) be connected between the IC's V_{IN} and GND pins.

Typical Performance Characteristics

(1) OUTPUT VOLTAGE vs. OUTPUT CURRENT

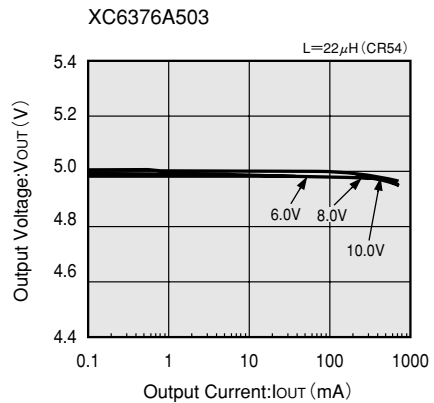
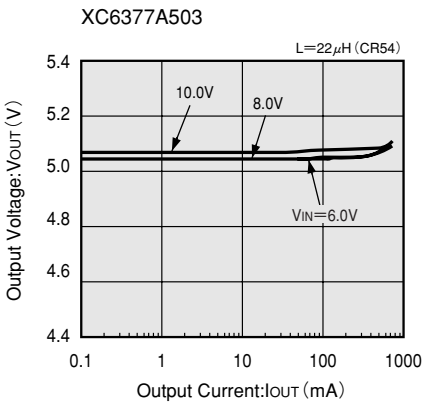
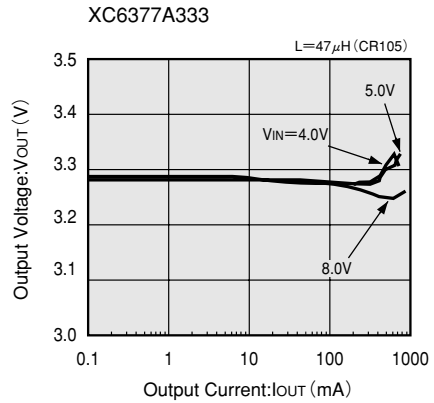
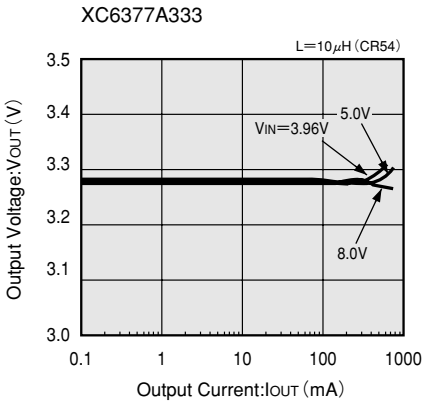
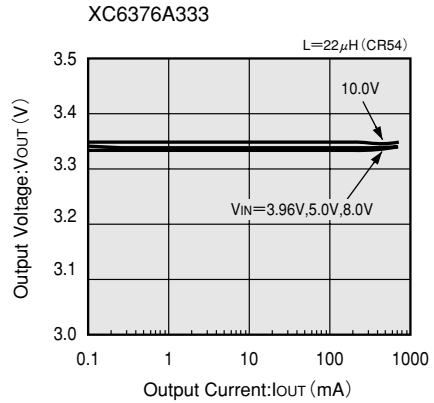
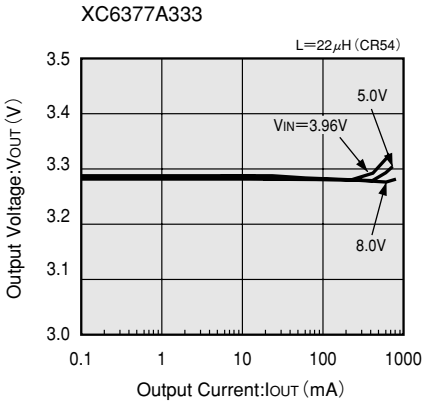

Note: <External component> C_{IN} = 47 μ F (Tantalum)

(2) EFFICIENCY vs. OUTPUT CURRENT

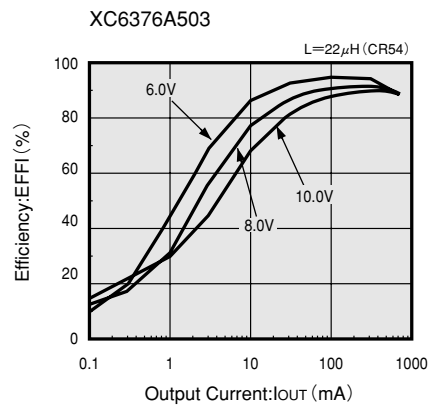
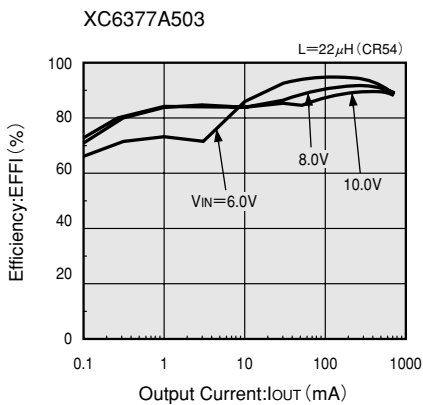
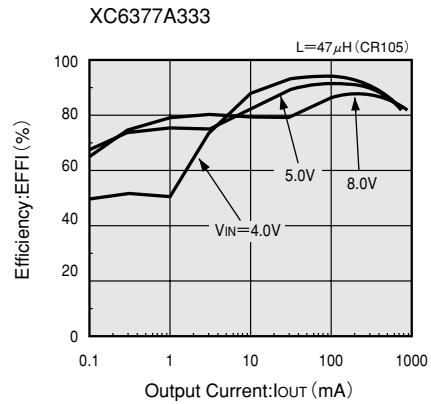
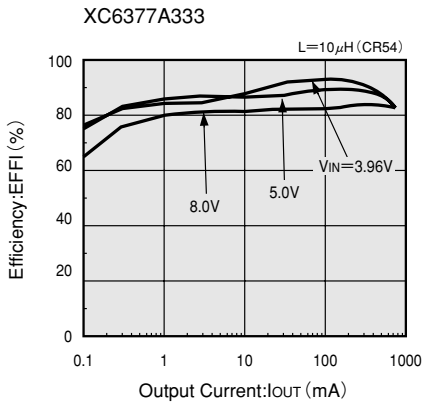
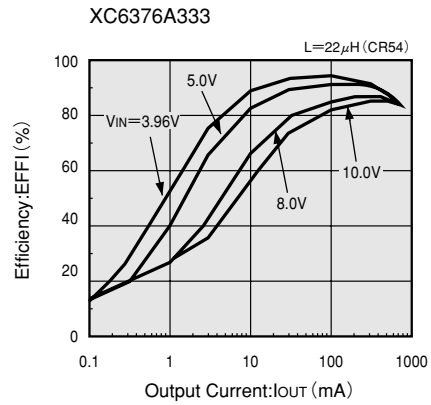
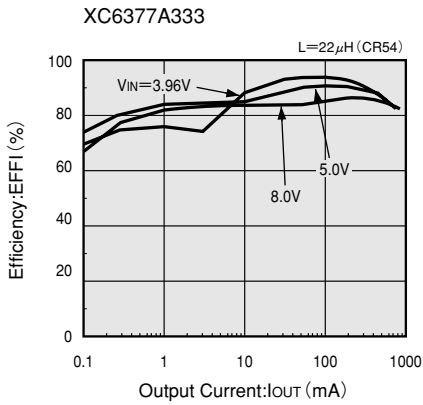

Note: <External component> C_{IN} = 47 μ F (Tantalum)

5

(3) OUTPUT VOLTAGE vs. AMBIENT TEMPERATURE

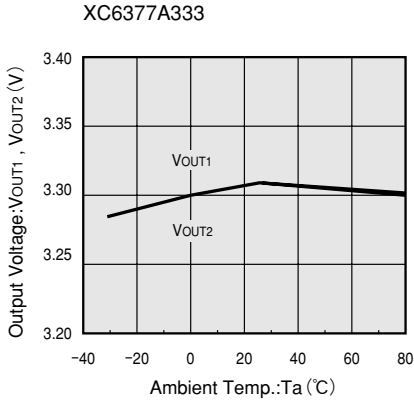

(4) SUPPLY CURRENT vs. AMBIENT TEMPERATURE

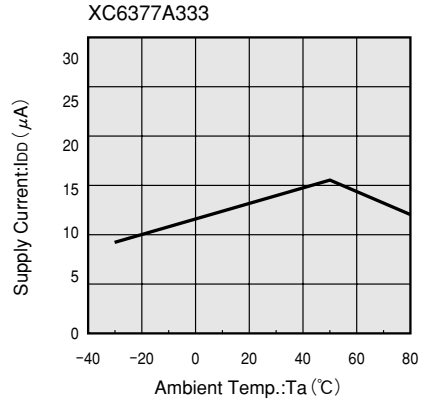

5

(5) STAND-BY CURRENT vs. AMBIENT TEMPERATURE

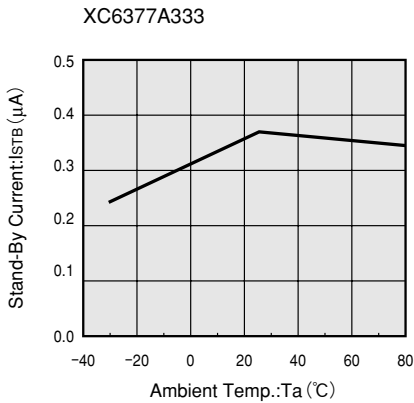

(6) Lx SWITCH ON RESISTANCE vs. AMBIENT TEMPERATURE

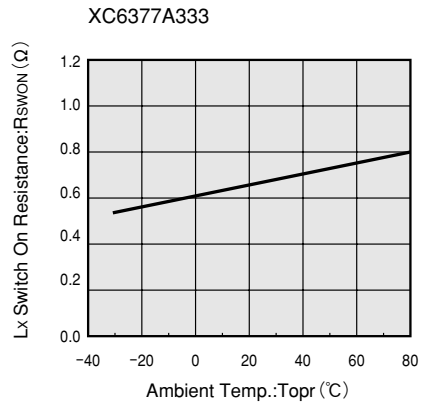

(7) OSCILLATION FREQUENCY vs. AMBIENT TEMPERATURE

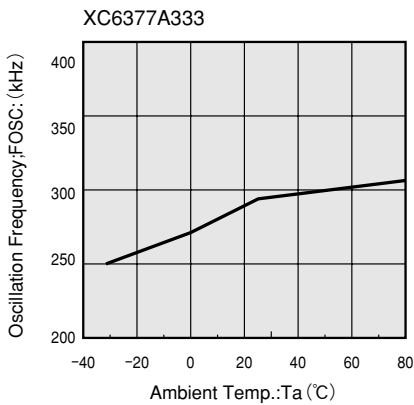

(8) PFM DUTY RATIO vs. AMBIENT TEMPERATURE

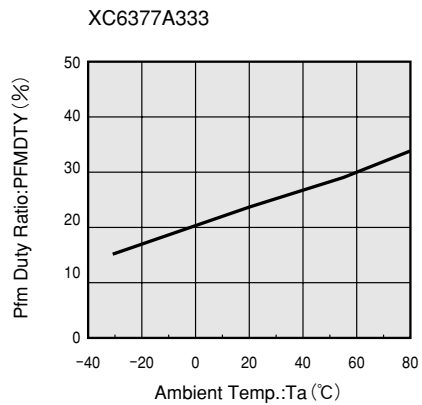

(9) EFFICIENCY vs. AMBIENT TEMPERATURE

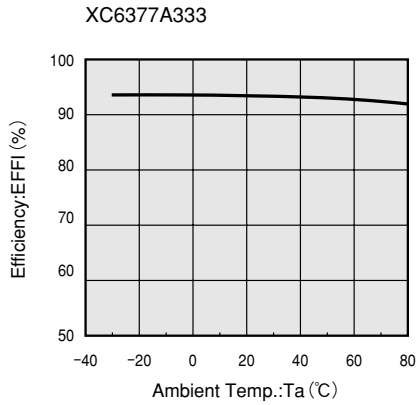

(10) MINIMUM OPERATING VOLTAGE vs. AMBIENT TEMPERATURE

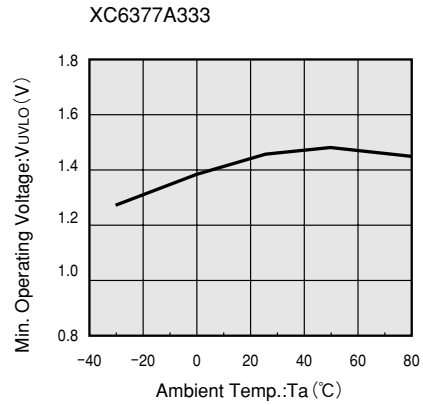

(11) SOFT START TIME vs. AMBIENT TEMPERATURE

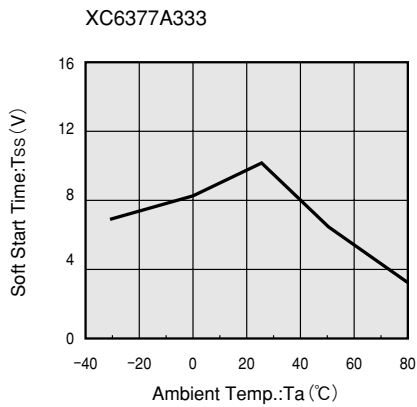

(12) CE "L" VOLTAGE vs. AMBIENT TEMPERATURE

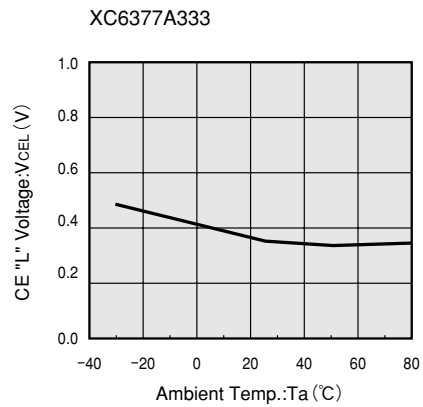

(13) CE "H" VOLTAGE vs. AMBIENT TEMPERATURE

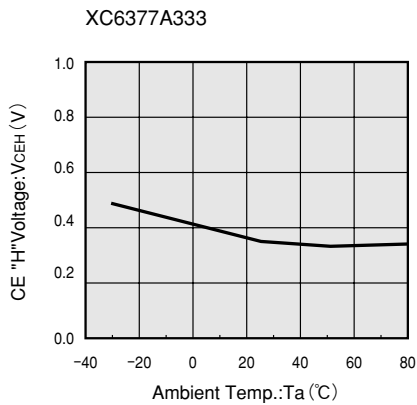

5

(14) LOAD TRANSIENT RESPONSE

XC6377A333

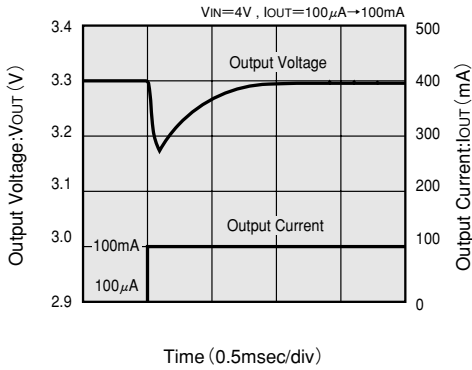

XC6377A333

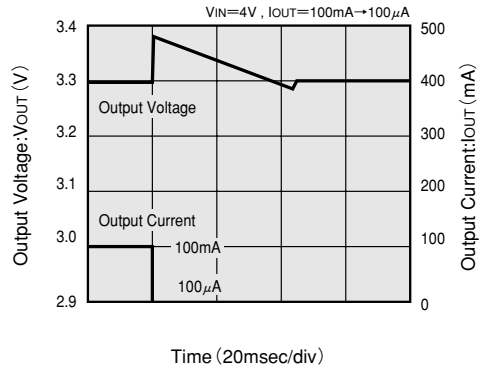

5

XC6377A333

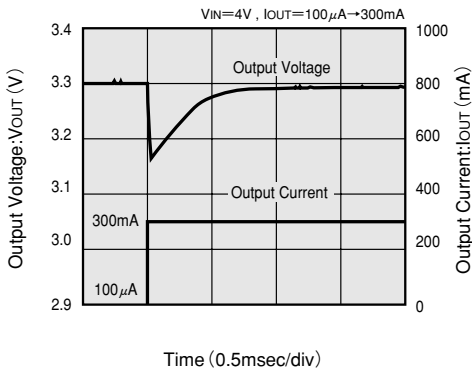

XC6377A333

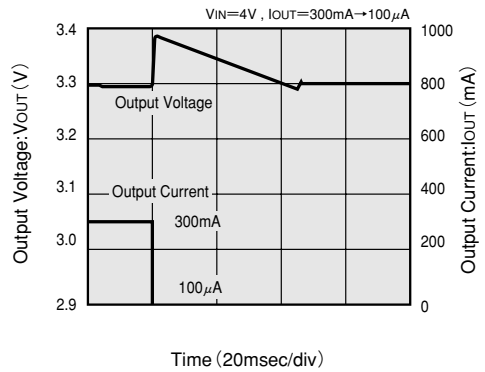

XC6377A333

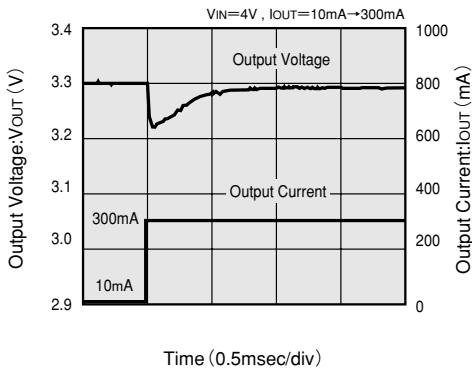

XC6377A333

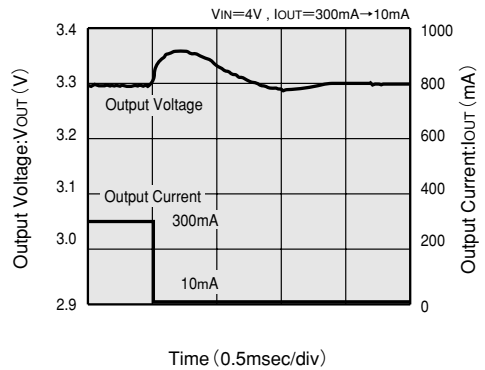

Typical Application Circuits

1. Large Current Output Circuit (P-channel power MOSFET external)

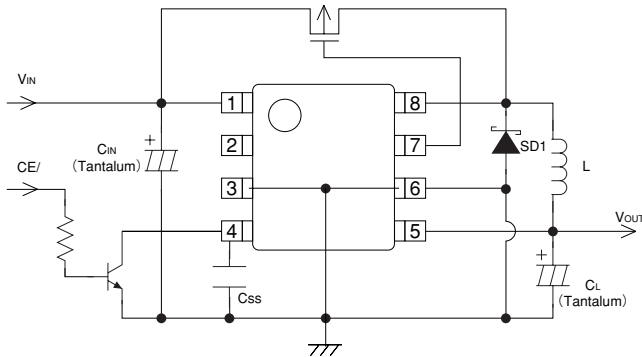

External Components :

L	:22 μ H(Sumida CR54,FOSC = 300kHz)
SD1	:U2FWJ44N(Diode, Toshiba)
CL	:10V 47 μ F+47 μ F(Tantalum capacitor, Nichicon MCE)
CSS	:4700pF(Ceramic capacitor)
CIN	:16V 47 μ F(Tantalum capacitor, Nichicon MCE) or 0.1 μ F (Ceramic capacitor)
Tr	:XP162A11C0RR or XP132A1275SR (Torex)

Note:In order to reduce impedance we recommend use of a capacitor (C_{IN}) with a large capacitance value or a ceramic capacitor with a low ESR value.

Please insert a by-pass capacitor of more than 0.1 μ F between pin Numbers 1 and 3.