



Dual N-Channel 20-V (D-S) MOSFET

TrenchFET[®] MOSFETs 1.8-V Rated



ESD Protected 2000 V

PRODUCT SUMMARY		
V _{DS} (V)	r _{DS(on)} (Ω)	I _D (mA)
20	0.70 @ V _{GS} = 4.5 V	600
	0.85 @ V _{GS} = 2.5 V	500
	1.25 @ V _{GS} = 1.8 V	350

FEATURES

- Very Small Footprint
- High-Side Switching
- Low On-Resistance: 0.7 Ω
- Low Threshold: 0.8 V (typ)
- Fast Switching Speed: 10 ns
- 1.8-V Operation
- Gate-Source ESD Protection

BENEFITS

- Ease in Driving Switches
- Low Offset (Error) Voltage
- Low-Voltage Operation
- High-Speed Circuits
- Low Battery Voltage Operation

APPLICATIONS

- Drivers: Relays, Solenoids, Lamps, Hammers, Displays, Memories
- Battery Operated Systems
- Power Supply Converter Circuits
- Load/Power Switching Cell Phones, Pagers

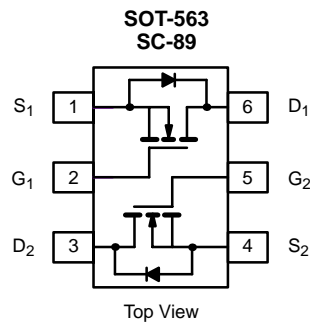

Marking Code: C

ABSOLUTE MAXIMUM RATINGS (T _A = 25 °C UNLESS OTHERWISE NOTED)				
Parameter	Symbol	5 secs	Steady State	Unit
Drain-Source Voltage	V _{DS}	20		V
Gate-Source Voltage	V _{GS}	±6		
Continuous Drain Current (T _J = 150 °C) ^a	T _A = 25 °C	515	485	mA
	T _A = 85 °C	370	350	
Pulsed Drain Current ^b	I _{DM}	650		
Continuous Source Current (diode conduction)	I _S	450	380	
Maximum Power Dissipation ^a	T _A = 25 °C	280	250	mW
	T _A = 85 °C	145	130	
Operating Junction and Storage Temperature Range	T _J , T _{stg}	-55 to 150		°C
Gate-Source ESD Rating (HBM, Method 3015)	ESD	2000		V

Notes

- a. Surface Mounted on FR4 Board.
- b. Pulse width limited by maximum junction temperature.

SPECIFICATIONS (T_J = 25 °C UNLESS OTHERWISE NOTED)

Parameter	Symbol	Test Condition	Min	Typ	Max	Unit
Static						
Gate Threshold Voltage	V _{GS(th)}	V _{DS} = V _{GS} , I _D = 250 μA	0.45			V
Gate-Body Leakage	I _{GSS}	V _{DS} = 0 V, V _{GS} = ±4.5 V		±0.5	±1.0	μA
Zero Gate Voltage Drain Current	I _{DSS}	V _{DS} = 16 V, V _{GS} = 0 V		0.3	100	nA
		V _{DS} = 16 V, V _{GS} = 0 V, T _J = 85 °C			5	μA
On-State Drain Current ^a	I _{D(on)}	V _{DS} = 5 V, V _{GS} = 4.5 V	700			mA
Drain-Source On-State Resistance ^a	r _{DS(on)}	V _{GS} = 4.5 V, I _D = 600 mA		0.41	0.70	Ω
		V _{GS} = 2.5 V, I _D = 500 mA		0.53	0.85	
		V _{GS} = 1.8 V, I _D = 350 mA		0.70	1.25	
Forward Transconductance ^a	g _{fs}	V _{DS} = 10 V, I _D = 400 mA		1.0		S
Diode Forward Voltage ^a	V _{SD}	I _S = 150 mA, V _{GS} = 0 V		0.8	1.2	V
Dynamic^b						
Total Gate Charge	Q _g	V _{DS} = 10 V, V _{GS} = 4.5 V, I _D = 250 mA		750		pC
Gate-Source Charge	Q _{gs}			75		
Gate-Drain Charge	Q _{gd}			225		
Turn-On Time	t _{ON}	V _{DD} = 10 V, R _L = 47 Ω I _D ≅ 200 mA, V _{GEN} = 4.5 V, R _G = 10 Ω		10		ns
Turn-Off Time	t _{OFF}			36		

Notes

- a. Pulse test; pulse width ≤ 300 μs, duty cycle ≤ 2%.
- b. Guaranteed by design, not subject to production testing.

TYPICAL CHARACTERISTICS (T_A = 25 °C UNLESS NOTED)

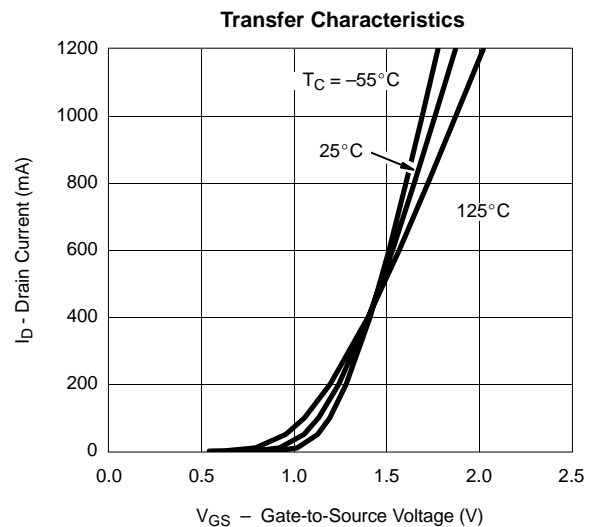
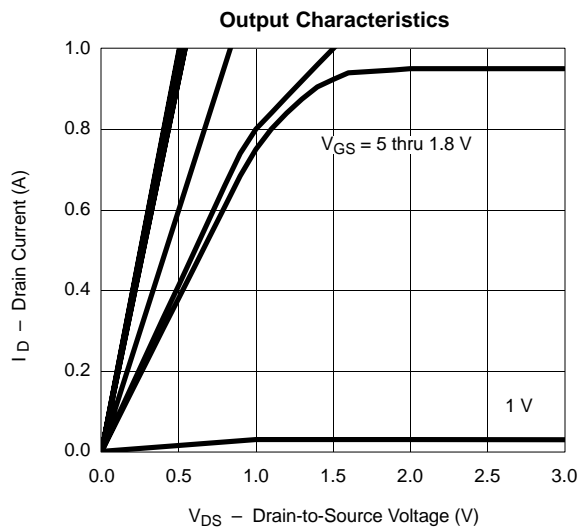



TYPICAL CHARACTERISTICS (T_A = 25°C UNLESS NOTED)

On-Resistance vs. Drain Current

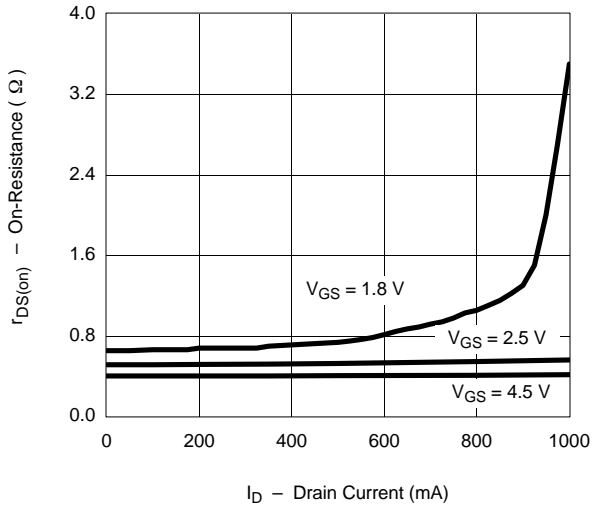

Capacitance

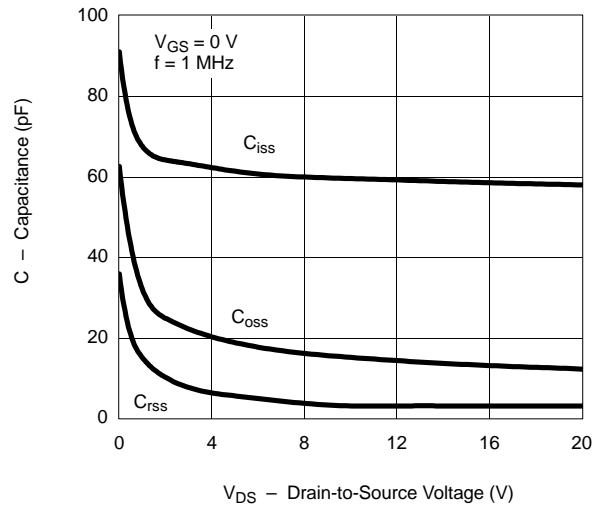

Gate Charge

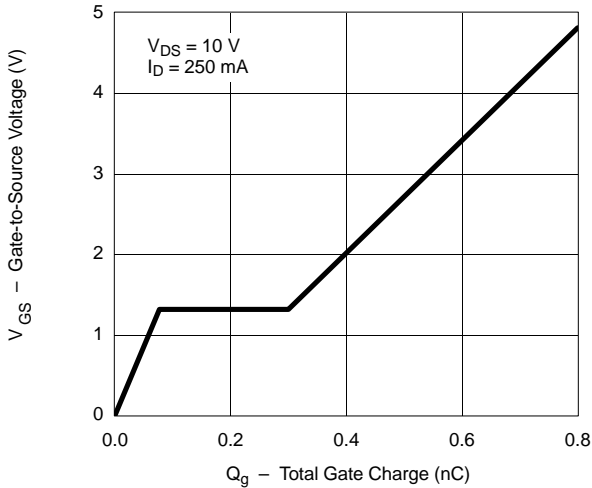

On-Resistance vs. Junction Temperature

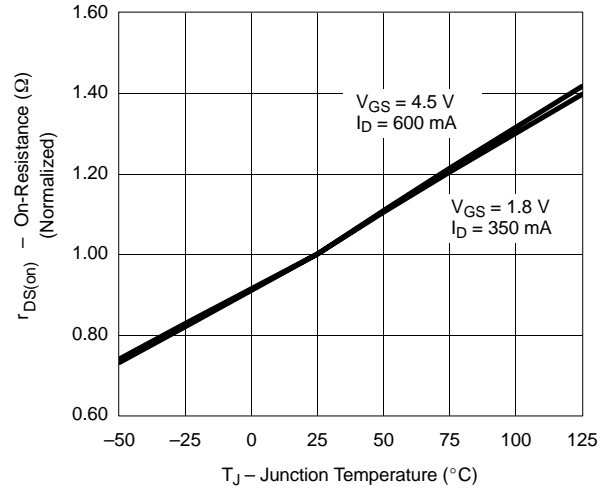

Source-Drain Diode Forward Voltage

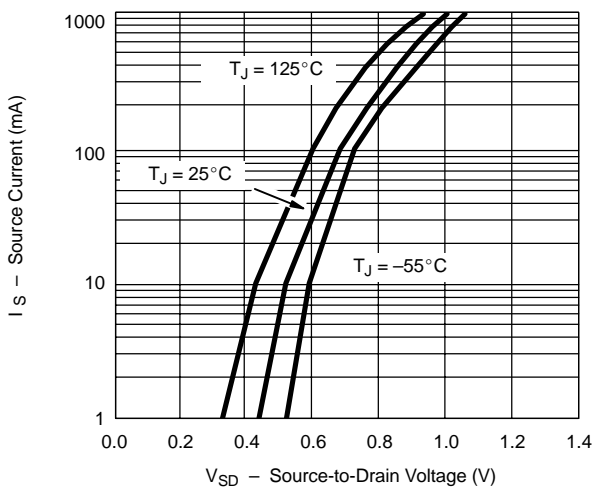

On-Resistance vs. Gate-to-Source Voltage

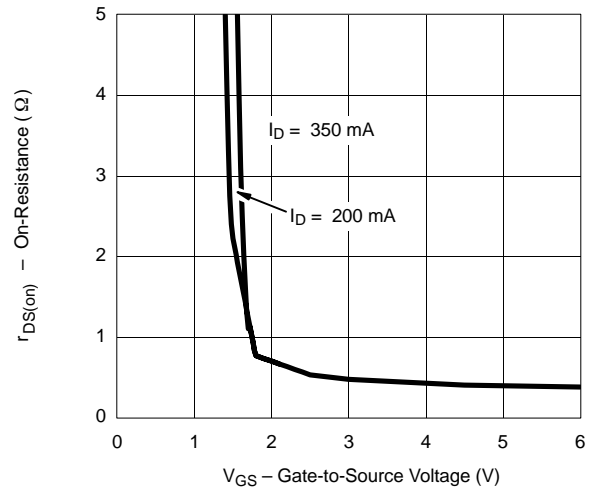

TYPICAL CHARACTERISTICS (T_A = 25°C UNLESS NOTED)

