

FEATURES

- **LOW COST PLASTIC SURFACE MOUNT PACKAGE**
- **HIGH OUTPUT POWER:** +35.5 dBm TYP
- **HIGH LINEAR GAIN:** 16 dB TYP @ 915 MHz
- **HIGH POWER ADDED EFFICIENCY:** 65% TYP @ $V_{DS} = 3.2\text{ V}$, $f = 915\text{ MHz}$
- **SINGLE SUPPLY:** 2.8 to 6.0 V
- **CLASS AB OPERATION**
- **SURFACE MOUNT PACKAGE:** 5.7x5.7x1.1 mm MAX

DESCRIPTION

NEC's NE5520379A is an N-Channel silicon power MOSFET specially designed as the transmission power amplifier for 3.2 V GSM900 handsets. Die are manufactured using NEC's NEWMOS technology (NEC's 0.6 μm WSi gate lateral MOSFET) and housed in a surface mount package. This device can deliver 35.5 dBm output power at 915 MHz and 3.2 V, or 34.6 dBm output power at 2.8 V by varying the gate voltage as a power control function.

OUTLINE DIMENSIONS (Units in mm)

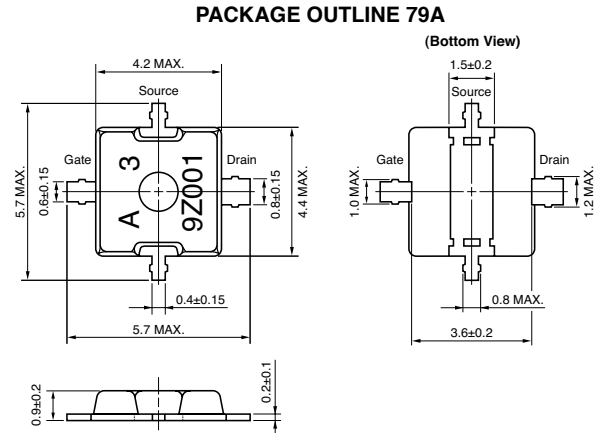

APPLICATIONS

- **DIGITAL CELLULAR PHONES:**
3.2 V GSM900/DCS 1800 Dual Band Handsets
- **OTHERS:**
Two-Way Pagers
Retail Business Radio
Special Mobile Radio
Short Range Wireless

ELECTRICAL CHARACTERISTICS ($T_A = 25^\circ\text{C}$)

PART NUMBER				NE5520379A			TEST CONDITIONS
PACKAGE OUTLINE				79A			
SYMBOLS	CHARACTERISTICS	UNITS	MIN	TYP	MAX		
Functional Characteristics	P_{OUT}	Output Power	dBm		35.5		$f = 915\text{ MHz}$, $V_{DS} = 3.2\text{ V}$, $V_{GS} = 2.5\text{ V(RF OFF)}$ (NOTE 1)
	G_L	Linear Gain (at $P_{IN} = +10\text{ dBm}$)	dB		16.0		
	η_D	Drain Efficiency	%		68		
	η_{ADD}	Power Added Efficiency	%		65		
	I_D	Operating Drain Current	A		1.0		
	P_{OUT}	Output Power	dBm	31.0	33.0		$f = 1785\text{ MHz}$, $V_{DS} = 3.2\text{ V}$, $V_{GS} = 2.5\text{ V}$ (NOTE 1)
	G_L	Linear Gain (at $P_{IN} = +10\text{ dBm}$)	dB		8.5		
	I_D	Operating Drain Current	mA		750		
	η_D	Drain Efficiency	%	29	38		
	η_{ADD}	Power Added Efficiency	%		35		
Electrical DC Characteristics	I_{GSS}	Gate-to-Source Leakage Current	nA			100	$V_{GS} = 6.0\text{ V}$
	I_{DSS}	Drain-to-Source Leakage Current	nA			100	$V_{DS} = 8.5\text{ V}$
	V_{TH}	Gate Threshold Voltage	V	1.0	1.35	2.0	$V_{DS} = 3.5\text{ V}$, $I_{DS} = 1\text{ mA}$
	g_m	Transconductance	S		2.5		$V_{DS} = 3.5\text{ V}$, $I_{DS1} = 0.8\text{ A}$, $I_{DS2} = 1.0\text{ A}$
	BV_{DSS}	Drain-to-Source Breakdown Voltage	V	15	20		$I_{DSS} = 10\text{ }\mu\text{A}$
	R_{TH}	Thermal Resistance	$^\circ\text{C/W}$			5	Channel-to-Case

Note:

1. DC performance is tested 100%. Several samples per wafer are tested for RF performance. Wafer rejection criteria for standard devices is 1 reject for several samples.

ABSOLUTE MAXIMUM RATINGS¹ (T_A = 25 °C)

SYMBOLS	PARAMETERS	UNITS	RATINGS
V _{DS}	Drain to Source Voltage	V	15.0
V _{GS}	Gate to Source Voltage	V	5.0
I _D	Drain Current	A	1.5
I _D	Drain Current (Pulse Test) ²	A	3.0
P _T	Total Power Dissipation	W	20
T _{CH}	Channel Temperature	°C	125
T _{STG}	Storage Temperature	°C	-65 to +125

Note:

1. Operation in excess of any one of these parameters may result in permanent damage.
2. Duty Cycle ≤ 50%, T_{on} ≤ 1 s.

RECOMMENDED OPERATING LIMITS

SYMBOLS	PARAMETERS	UNITS	TYP	MAX
V _{DS}	Drain to Source Voltage	V	3.2	6.0
V _{GS}	Gate to Source Voltage	V	2.5	3.5
I _{DS}	Drain Current (Pulse Test)	A	1.75	2.0
P _{IN}	Input Power	dBm	25	26

ORDERING INFORMATION

PART NUMBER	QTY
NE5520379A-T1A-A	

TYPICAL PERFORMANCE CURVES (T_A = 25°C)

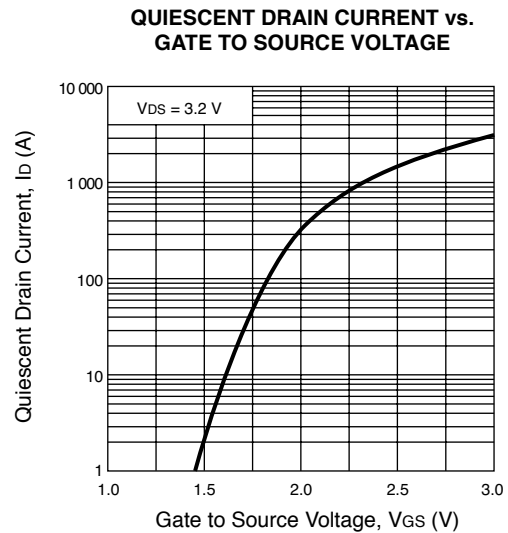
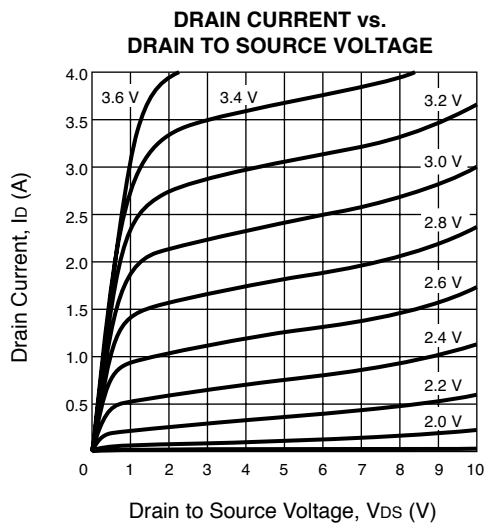

TYPICAL PERFORMANCE CURVES ($T_A = 25^\circ\text{C}$)

OUTPUT POWER, DRAIN CURRENT vs. INPUT POWER (460 MHz)

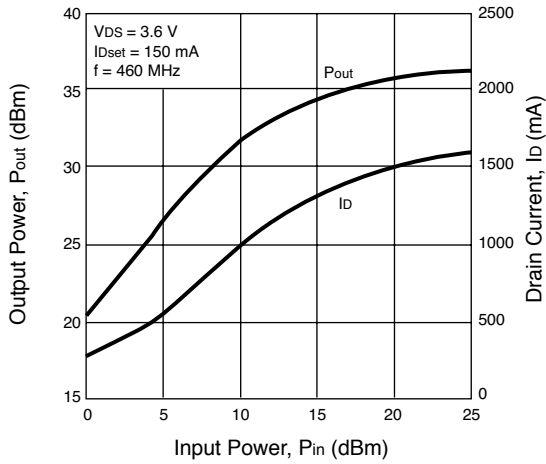

DRAIN EFFICIENCY, POWER ADDED EFFICIENCY vs. INPUT POWER

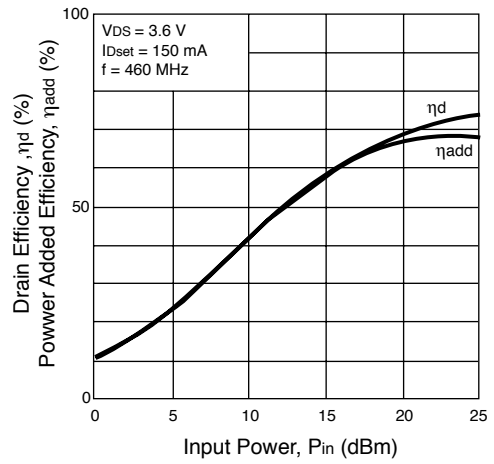

OUTPUT POWER, DRAIN CURRENT vs. INPUT POWER

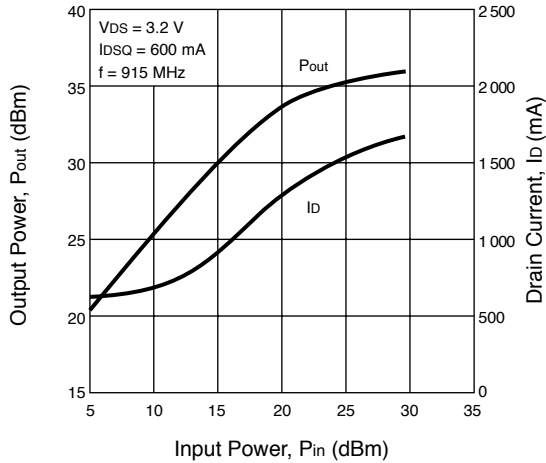

DRAIN EFFICIENCY, POWER ADDED EFFICIENCY vs. INPUT POWER

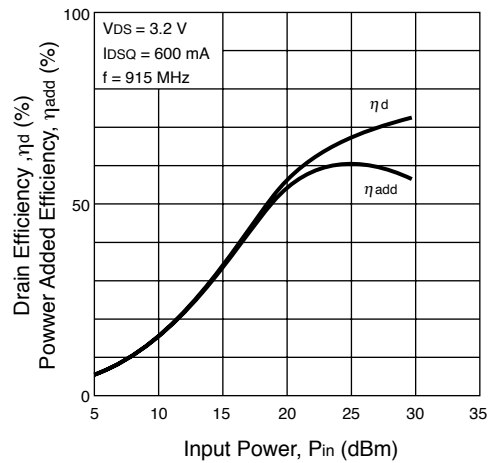

OUTPUT POWER, DRAIN CURRENT vs. INPUT POWER

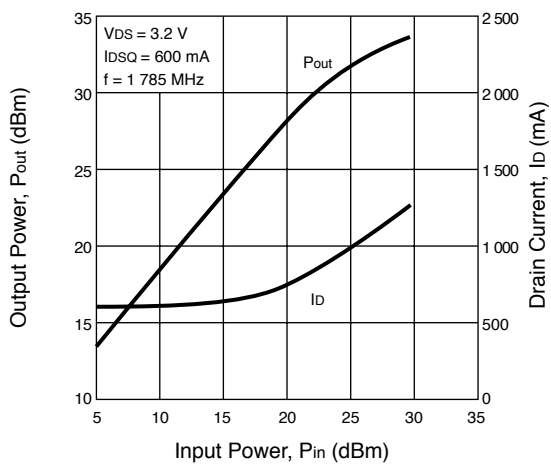

DRAIN EFFICIENCY, POWER ADDED EFFICIENCY vs. INPUT POWER

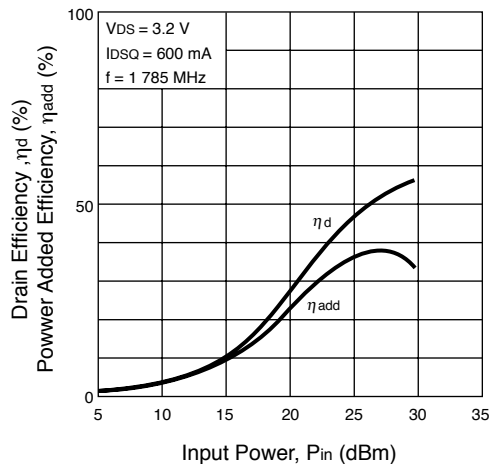

TYPICAL PERFORMANCE CURVES ($T_A = 25^\circ\text{C}$)

OUTPUT POWER, DRAIN CURRENT vs. GATE TO SOURCE VOLTAGE

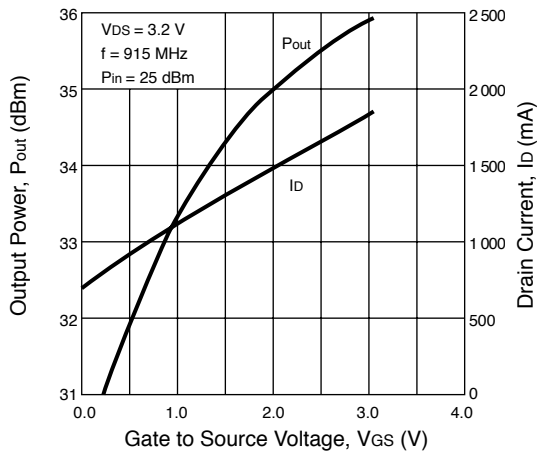

OUTPUT POWER, DRAIN CURRENT vs. GATE TO SOURCE VOLTAGE

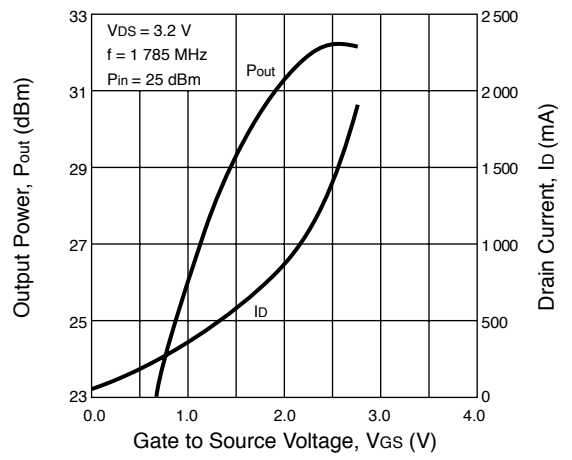

TYPICAL SCATTERING PARAMETERS (TA = 25°C)

Note: This file and many other s-parameter files can be downloaded from www.cel.com

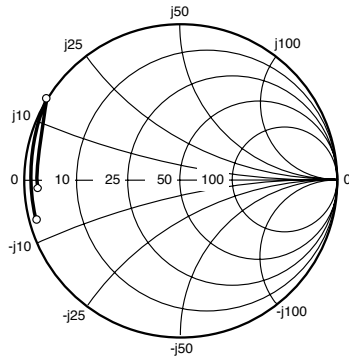

Coordinates in Ohms
Frequency in GHz
V_D = 2.4 V, I_D = 300 mA

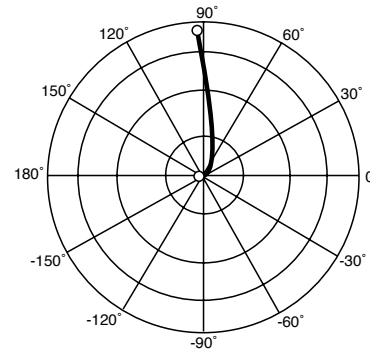

NE5520379A

V_D = 2.4 V, I_D = 300 mA

FREQUENCY GHz	S ₁₁		S ₂₁		S ₁₂		S ₂₂		K	MAG ¹ (dB)
	MAG	ANG	MAG	ANG	MAG	ANG	MAG	ANG		
0.10	0.91	-166.00	4.96	91.46	0.02	2.83	0.87	-177.51	0.12	24.77
0.15	0.91	-171.34	3.32	86.63	0.02	-3.69	0.87	-178.85	0.16	22.87
0.20	0.91	-174.19	2.48	82.34	0.02	-4.78	0.87	-179.72	0.24	21.67
0.25	0.91	-176.05	1.98	78.94	0.02	-7.98	0.87	179.68	0.29	20.65
0.30	0.92	-177.47	1.63	75.61	0.02	-9.01	0.87	179.13	0.37	19.83
0.35	0.92	-178.62	1.39	72.51	0.02	-11.04	0.87	178.64	0.44	19.13
0.40	0.92	-179.56	1.20	69.74	0.02	-14.40	0.88	178.26	0.50	18.71
0.45	0.92	179.62	1.06	66.85	0.02	-16.23	0.88	177.80	0.56	18.21
0.50	0.92	178.83	0.94	64.15	0.02	-18.73	0.88	177.43	0.63	17.79
0.55	0.92	178.12	0.85	61.50	0.02	-20.26	0.88	176.97	0.71	17.43
0.60	0.92	177.42	0.77	58.92	0.01	-19.69	0.88	176.61	0.87	17.25
0.65	0.93	176.76	0.70	56.40	0.01	-22.40	0.89	176.14	0.86	16.77
0.70	0.93	176.09	0.64	53.87	0.01	-24.70	0.89	175.63	0.93	16.44
0.75	0.93	175.48	0.59	51.57	0.01	-26.30	0.89	175.27	1.05	14.89
0.80	0.93	174.86	0.54	49.32	0.01	-27.01	0.89	174.81	1.12	13.95
0.85	0.93	174.22	0.50	46.99	0.01	-28.40	0.89	174.31	1.27	12.74
0.90	0.93	173.60	0.47	44.90	0.01	-29.48	0.90	173.93	1.33	12.17
0.95	0.94	173.03	0.44	42.72	0.01	-31.03	0.90	173.42	1.44	11.53
1.00	0.94	172.43	0.41	40.69	0.01	-31.65	0.90	172.99	1.61	10.79
1.20	0.94	170.05	0.32	33.12	0.01	-35.32	0.91	171.08	2.08	8.96
1.30	0.95	168.90	0.28	29.64	0.01	-38.66	0.91	170.17	2.43	8.10
1.40	0.95	167.71	0.25	26.30	0.01	-40.07	0.91	169.12	2.88	7.18
1.50	0.95	166.62	0.23	23.15	0.01	-40.31	0.92	168.10	3.31	6.55
1.60	0.95	165.46	0.21	20.23	0.01	-42.08	0.92	167.21	4.05	5.86
1.70	0.95	164.33	0.19	17.61	0.01	-41.45	0.92	166.35	4.91	5.12
1.80	0.96	163.28	0.17	15.02	0.01	-41.35	0.92	165.39	5.68	4.38
1.90	0.96	162.22	0.16	12.55	0.00	-40.16	0.93	164.37	7.09	3.84
2.00	0.96	161.21	0.14	10.37	0.00	-35.50	0.93	163.55	8.29	3.46
2.10	0.96	160.17	0.13	8.42	0.00	-30.05	0.93	162.80	11.07	2.90
2.20	0.96	159.17	0.12	6.46	0.00	-21.25	0.93	161.93	14.89	2.19
2.30	0.96	158.29	0.11	4.59	0.00	-15.26	0.94	160.98	16.85	1.67
2.40	0.96	157.41	0.11	3.14	0.00	-1.99	0.94	160.15	18.02	1.65
2.50	0.97	156.53	0.10	1.92	0.00	9.51	0.95	159.57	16.22	1.49
2.60	0.97	155.72	0.09	0.69	0.00	17.40	0.95	158.86	18.87	0.98
2.70	0.97	154.92	0.09	-0.82	0.00	49.62	0.95	158.02	17.17	0.60
2.80	0.97	154.17	0.08	-2.13	0.00	54.56	0.95	157.17	17.91	0.80
2.90	0.97	153.44	0.08	-3.31	0.00	75.69	0.96	156.56	11.30	0.89
3.00	0.97	152.77	0.07	-4.03	0.00	84.78	0.96	155.94	12.00	0.68
3.10	0.97	152.20	0.07	-4.64	0.00	91.22	0.97	155.48	7.64	0.86
3.20	0.98	151.52	0.06	-5.69	0.00	89.31	0.97	154.37	6.03	0.83
3.30	0.98	150.94	0.06	-5.93	0.00	94.43	0.98	153.79	4.52	1.47
3.40	0.98	150.36	0.06	-6.52	0.01	93.75	0.98	153.16	3.50	1.69
3.50	0.98	149.78	0.05	-6.88	0.01	93.93	0.98	152.45	3.08	1.43
4.00	0.99	148.45	0.04	-5.44	0.01	93.64	0.99	150.04	1.13	4.11

Note:

1. Gain Calculation:

$$MAG = \frac{|S_{21}|}{|S_{12}|} (K \pm \sqrt{K^2 - 1})$$

When $K \leq 1$, MAG is undefined and MSG values are used. $MSG = \frac{|S_{21}|}{|S_{12}|}$, $K = \frac{1 + |\Delta|^2 - |S_{11}|^2 - |S_{22}|^2}{2 |S_{12}| |S_{21}|}$, $\Delta = S_{11} S_{22} - S_{21} S_{12}$

MAG = Maximum Available Gain

MSG = Maximum Stable Gain

TYPICAL SCATTERING PARAMETERS (TA = 25°C)

Note: This file and many other s-parameter files can be downloaded from www.cel.com

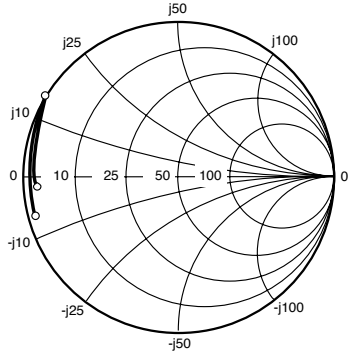

**Coordinates in Ohms
Frequency in GHz
VD = 3.0 V, ID = 600 mA**

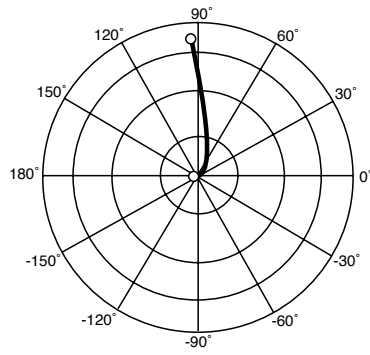

NE5520379A

VD = 3.0 V, ID = 600 mA

FREQUENCY GHz	S11		S21		S12		S22		K	MAG ¹ (dB)
	MAG	ANG	MAG	ANG	MAG	ANG	MAG	ANG		
0.10	0.93	-166.51	5.08	92.43	0.01	4.88	0.89	-178.46	0.14	26.14
0.15	0.93	-171.79	3.41	88.12	0.01	-2.92	0.89	-179.65	0.15	24.16
0.20	0.93	-174.68	2.54	84.33	0.01	-2.57	0.89	179.54	0.25	23.01
0.25	0.93	-176.58	2.03	81.48	0.01	-2.60	0.89	178.98	0.33	21.95
0.30	0.93	-178.04	1.69	78.54	0.01	-5.09	0.89	178.33	0.39	21.14
0.35	0.93	-179.24	1.44	75.97	0.01	-7.10	0.89	177.89	0.47	20.48
0.40	0.93	179.79	1.25	73.62	0.01	-9.56	0.89	177.44	0.52	20.03
0.45	0.93	178.92	1.11	71.09	0.01	-11.04	0.89	176.93	0.59	19.51
0.50	0.93	178.11	0.99	68.88	0.01	-12.64	0.89	176.63	0.68	19.16
0.55	0.94	177.36	0.89	66.51	0.01	-12.76	0.90	176.06	0.75	18.72
0.60	0.94	176.64	0.81	64.31	0.01	-13.34	0.89	175.72	0.93	18.57
0.65	0.94	175.96	0.75	62.14	0.01	-14.37	0.90	175.29	0.91	18.08
0.70	0.94	175.28	0.69	59.81	0.01	-16.01	0.90	174.68	1.02	17.03
0.75	0.94	174.66	0.63	57.87	0.01	-17.13	0.90	174.42	1.14	15.30
0.80	0.94	174.05	0.59	55.81	0.01	-16.95	0.90	173.89	1.18	14.78
0.85	0.94	173.41	0.55	53.68	0.01	-18.56	0.90	173.39	1.39	13.45
0.90	0.94	172.80	0.51	51.88	0.01	-19.71	0.90	173.13	1.40	13.11
0.95	0.94	172.21	0.48	49.77	0.01	-19.61	0.90	172.51	1.52	12.48
1.00	0.94	171.63	0.45	47.95	0.01	-19.95	0.90	172.16	1.71	11.68
1.10	0.94	170.41	0.40	44.15	0.01	-24.20	0.91	171.11	1.93	10.81
1.20	0.95	169.32	0.36	40.82	0.01	-23.13	0.91	170.30	2.13	10.08
1.30	0.95	168.20	0.32	37.55	0.01	-24.29	0.91	169.48	2.56	9.13
1.40	0.95	167.05	0.29	34.19	0.01	-25.78	0.91	168.40	3.14	8.10
1.50	0.95	166.00	0.27	30.96	0.01	-25.39	0.92	167.30	3.52	7.56
1.60	0.95	164.89	0.24	28.24	0.01	-25.03	0.92	166.57	4.07	7.05
1.70	0.95	163.80	0.22	25.67	0.01	-22.37	0.92	165.86	4.72	6.28
1.80	0.95	162.78	0.20	22.92	0.00	-20.35	0.92	164.91	6.13	5.28
1.90	0.96	161.76	0.19	20.12	0.00	-18.82	0.92	163.74	7.13	4.85
2.00	0.96	160.78	0.18	17.88	0.00	-12.65	0.93	162.96	7.85	4.65
2.10	0.96	159.78	0.16	16.09	0.00	-5.72	0.93	162.54	9.04	4.16
2.20	0.96	158.80	0.15	14.12	0.00	2.28	0.93	161.73	11.69	3.15
2.30	0.96	157.95	0.14	12.01	0.00	9.59	0.93	160.62	12.90	2.58
2.40	0.96	157.10	0.13	10.33	0.00	16.52	0.94	159.68	11.53	2.95
2.50	0.96	156.24	0.12	9.11	0.00	24.13	0.95	159.46	10.27	2.98
2.60	0.96	155.45	0.12	7.63	0.00	38.01	0.94	158.99	11.45	2.19
2.70	0.97	154.66	0.11	5.72	0.00	48.37	0.94	158.00	10.95	1.62
2.80	0.97	153.93	0.10	3.94	0.00	55.62	0.95	156.90	10.04	2.00
2.90	0.97	153.22	0.10	2.73	0.00	64.87	0.96	156.45	7.62	2.62
3.00	0.97	152.55	0.09	1.96	0.00	69.74	0.96	156.03	7.17	2.29
3.10	0.97	152.00	0.09	1.15	0.00	81.95	0.96	155.48	6.39	2.11
3.20	0.97	151.33	0.08	-0.21	0.00	80.85	0.97	154.23	5.03	2.21
3.30	0.98	150.77	0.08	-0.76	0.01	86.32	0.97	153.57	3.62	3.03
3.40	0.98	150.20	0.07	-1.47	0.01	86.22	0.98	153.08	3.20	3.00
3.50	0.98	149.63	0.07	-2.27	0.01	87.98	0.97	152.19	3.09	2.26
4.00	0.99	148.33	0.05	-2.98	0.01	88.38	0.98	149.87	1.37	3.81

Note:

1. Gain Calculation:

$$MAG = \frac{|S_{21}|}{|S_{12}|} (K \pm \sqrt{K^2 - 1})$$

When $K \leq 1$, MAG is undefined and MSG values are used. $MSG = \frac{|S_{21}|}{|S_{12}|}$, $K = \frac{1 + |\Delta|^2 - |S_{11}|^2 - |S_{22}|^2}{2 |S_{12}| |S_{21}|}$, $\Delta = S_{11} S_{22} - S_{21} S_{12}$

MAG = Maximum Available Gain

MSG = Maximum Stable Gain

APPLICATION CIRCUIT (900 MHz)

P.C.B. LAYOUT (Units in mm)

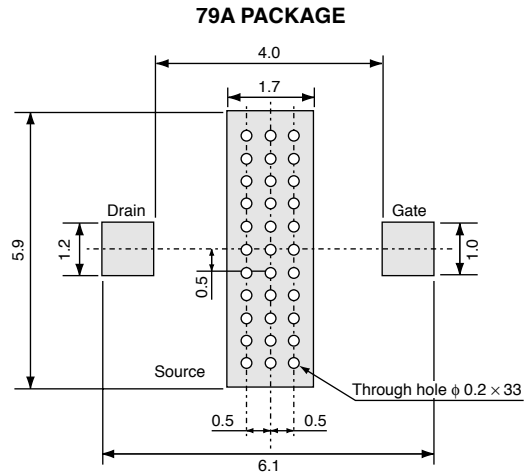
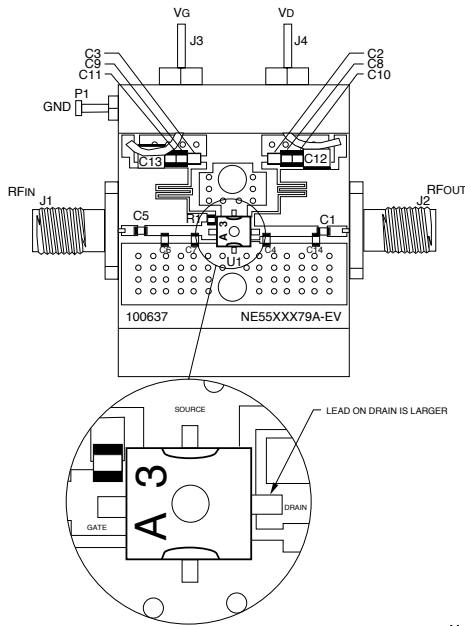

Note:
Use rosin or other material to prevent solder from penetrating through-holes.

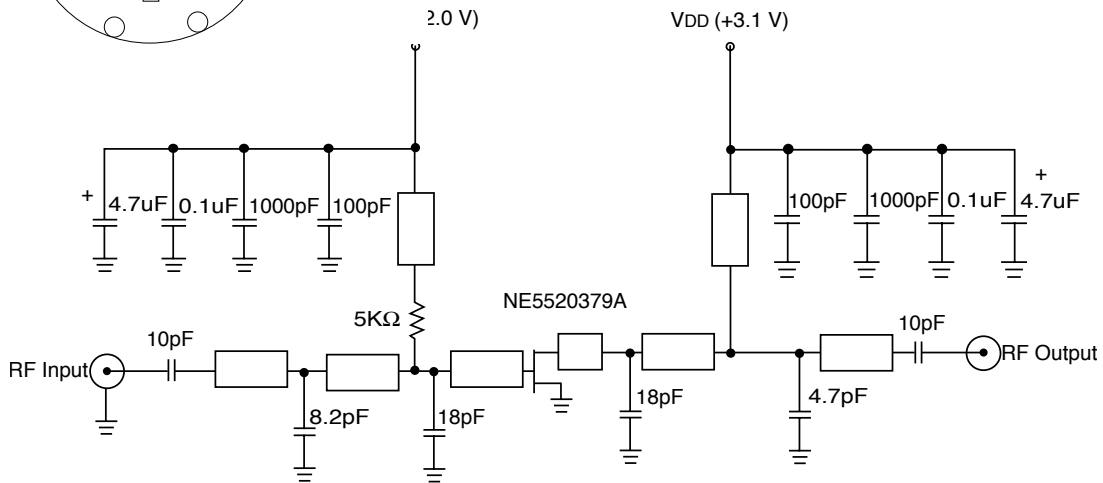

NE5520379A PARTS LIST

1	TF-100637		TEST CIRCUIT BLK	16
4			2-56 X 3/16 PHILLIPS PAN HEAD	15
2	MA101J	C2, C3	CASE 1100 pF CAP MURATA	14
1	MCR03J512	R1	0603 5.1K OHMS RESISTOR ROHM	13
2	MCH185A180JK	C4, C7	0603 18 pF CAP ROHM	12
1	MCH185A4R7CK	C14	0603 4.7 pF CAP ROHM	11
2	MCH185A100DK	C1, C5	0603 10 pF CAP ROHM	10
1	MCH185A8R2DK	C6	0603 8.2 pF CAP ROHM	9
2	TAJB475K010R	C12, C13	CASE B 4.7 uF CAP ATC	8
2	GRM40X7R104K025BL	C10, C11	0805 .1 uF CAP MURATA	7
2	GRM40C0G102J050BD	C8, C9	0805 1000 pF CAP MURATA6	7
1	NE5520379A	U1	IC NEC, LD-MOS FET	5
1	703401	P1	GROUND LUG CONCORD	4
1	1250-003	J3, J4	FEEDTHRU MURATA	3
2	2052-5636-02	J1, J2	FLANGE MOUNT JACK RECEPTACLE	2
1	FD-100637	PCB	NE5520379A-EVAL FAB. DRAWING	1

RECOMMENDED SOLDERING CONDITIONS

This product

those recommended below, contact your nearby sales office.

Soldering Method	Soldering Conditions	Condition Symbol
Infrared Reflow	Peak temperature (package surface temperature) : 260°C or below Time at peak temperature : 10 seconds or less Time at temperature of 220°C or higher : 60 seconds or less Preheating time at 120 to 180°C : 120±30 seconds Maximum number of reflow processes : 3 times Maximum chlorine content of rosin flux (% mass) : 0.2%(Wt.) or below	IR260
VPS	Peak temperature (package surface temperature) : 215°C or below Time at temperature of 200°C or higher : 25 to 40 seconds Preheating time at 120 to 150°C : 30 to 60 seconds Maximum number of reflow processes : 3 times Maximum chlorine content of rosin flux (% mass) : 0.2%(Wt.) or below	VP215
Wave Soldering	Peak temperature (molten solder temperature) : 260°C or below Time at peak temperature : 10 seconds or less Preheating temperature (package surface temperature) : 120°C or below Maximum number of flow processes : 1 time Maximum chlorine content of rosin flux (% mass) : 0.2%(Wt.) or below	WS260
Partial Heating	Peak temperature (pin temperature) : 350°C or below Soldering time (per pin of device) : 3 seconds or less Maximum chlorine content of rosin flux (% mass) : 0.2%(Wt.) or below	HS350-P3

Caution Do not use different soldering methods together (except for partial heating).

Life Support Applications

These NEC products are not intended for use in life support devices, appliances, or systems where the malfunction of these products can reasonably be expected to result in personal injury. The customers of CEL using or selling these products for use in such applications do so at their own risk and agree to fully indemnify CEL for all damages resulting from such improper use or sale.

CEL California Eastern Laboratories, Your source for NEC RF, Microwave, Optoelectronic, and Fiber Optic Semiconductor Devices.

4590 Patrick Henry Drive • Santa Clara, CA 95054-1817 • (408) 988-3500 • FAX (408) 988-0279 • www.cel.com

DATA SUBJECT TO CHANGE WITHOUT NOTICE

03/08/2005

Subject: Compliance with EU Directives

CEL certifies, to its knowledge, that semiconductor and laser products detailed below are compliant with the requirements of European Union (EU) Directive 2002/95/EC Restriction on Use of Hazardous Substances in electrical and electronic equipment (RoHS) and the requirements of EU Directive 2003/11/EC Restriction on Penta and Octa BDE.

CEL Pb-free products have the same base part number with a suffix added. The suffix –A indicates that the device is Pb-free. The –AZ suffix is used to designate devices containing Pb which are exempted from the requirement of RoHS directive (*). In all cases the devices have Pb-free terminals. All devices with these suffixes meet the requirements of the RoHS directive.

This status is based on CEL’s understanding of the EU Directives and knowledge of the materials that go into its products as of the date of disclosure of this information.

Restricted Substance per RoHS	Concentration Limit per RoHS (values are not yet fixed)	Concentration contained in CEL devices	
		-A	-AZ
Lead (Pb)	< 1000 PPM	Not Detected	(*)
Mercury	< 1000 PPM	Not Detected	
Cadmium	< 100 PPM	Not Detected	
Hexavalent Chromium	< 1000 PPM	Not Detected	
PBB	< 1000 PPM	Not Detected	
PBDE	< 1000 PPM	Not Detected	

If you should have any additional questions regarding our devices and compliance to environmental standards, please do not hesitate to contact your local representative.

Important Information and Disclaimer: Information provided by CEL on its website or in other communications concerning the substance content of its products represents knowledge and belief as of the date that it is provided. CEL bases its knowledge and belief on information provided by third parties and makes no representation or warranty as to the accuracy of such information. Efforts are underway to better integrate information from third parties. CEL has taken and continues to take reasonable steps to provide representative and accurate information but may not have conducted destructive testing or chemical analysis on incoming materials and chemicals. CEL and CEL suppliers consider certain information to be proprietary, and thus CAS numbers and other limited information may not be available for release.

In no event shall CEL’s liability arising out of such information exceed the total purchase price of the CEL part(s) at issue sold by CEL to customer on an annual basis.

See CEL Terms and Conditions for additional clarification of warranties and liability.