

# SHINDENGEN

## Schottky Rectifiers (SBD)

Dual

# DF30SC4M

## 40V 30A

### FEATURES

- SMT
- Tj150
- P<sub>RRSM</sub> avalanche guaranteed
- High current capacity with Small Package

### APPLICATION

- Switching power supply
- DC/DC converter
- Home Appliances, Office Equipment
- Telecommunication

### OUTLINE DIMENSIONS

Case : STO-220

Unit : mm

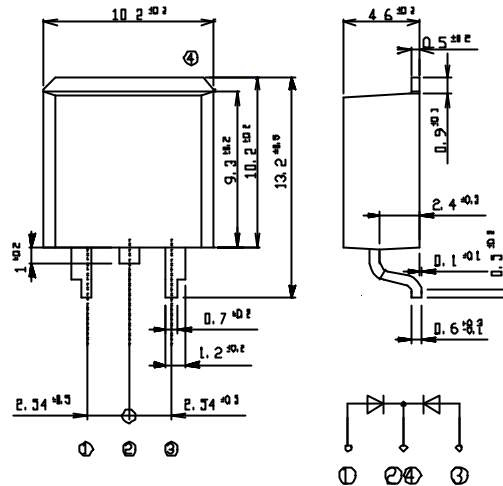

### RATINGS

Absolute Maximum Ratings (If not specified Tc=25 )

Item	Symbol	Conditions	Ratings	Unit
Storage Temperature	T <sub>stg</sub>		-40 ~ 150	
Operating Junction Temperature	T <sub>j</sub>		150	
Maximum Reverse Voltage	V <sub>RM</sub>		40	V
Repetitive Peak Surge Reverse Voltage	V <sub>RRSM</sub>	Pulse width 0.5ms, duty 1/40	45	V
Average Rectified Forward Current	I <sub>O</sub>	50Hz sine wave, R-load, Rating for each diode I <sub>O</sub> /2, T <sub>c</sub> =112	30	A
Peak Surge Forward Current	I <sub>FSM</sub>	50Hz sine wave, Non-repetitive 1 cycle peak value, T <sub>j</sub> =25	360	A
Repetitive Peak Surge Reverse Power	P <sub>RRSM</sub>	Pulse width 10 μs, Rating of per diode, T <sub>j</sub> = 25	1000	W

Electrical Characteristics (If not specified Tc=25 )

Item	Symbol	Conditions	Ratings	Unit
Forward Voltage	V <sub>F</sub>	I <sub>F</sub> =15A, Pulse measurement, Rating of per diode	Max.0.55	V
Reverse Current	I <sub>R</sub>	V <sub>R</sub> =V <sub>RM</sub> , Pulse measurement, Rating of per diode	Max.10	mA
Junction Capacitance	C <sub>j</sub>	f=1MHz, V <sub>R</sub> =10V, Rating of per diode	Typ.590	pF
Thermal Resistance	θ <sub>c</sub>	junction to case	Max.1.6	/W

# DF30SC4M Forward Voltage

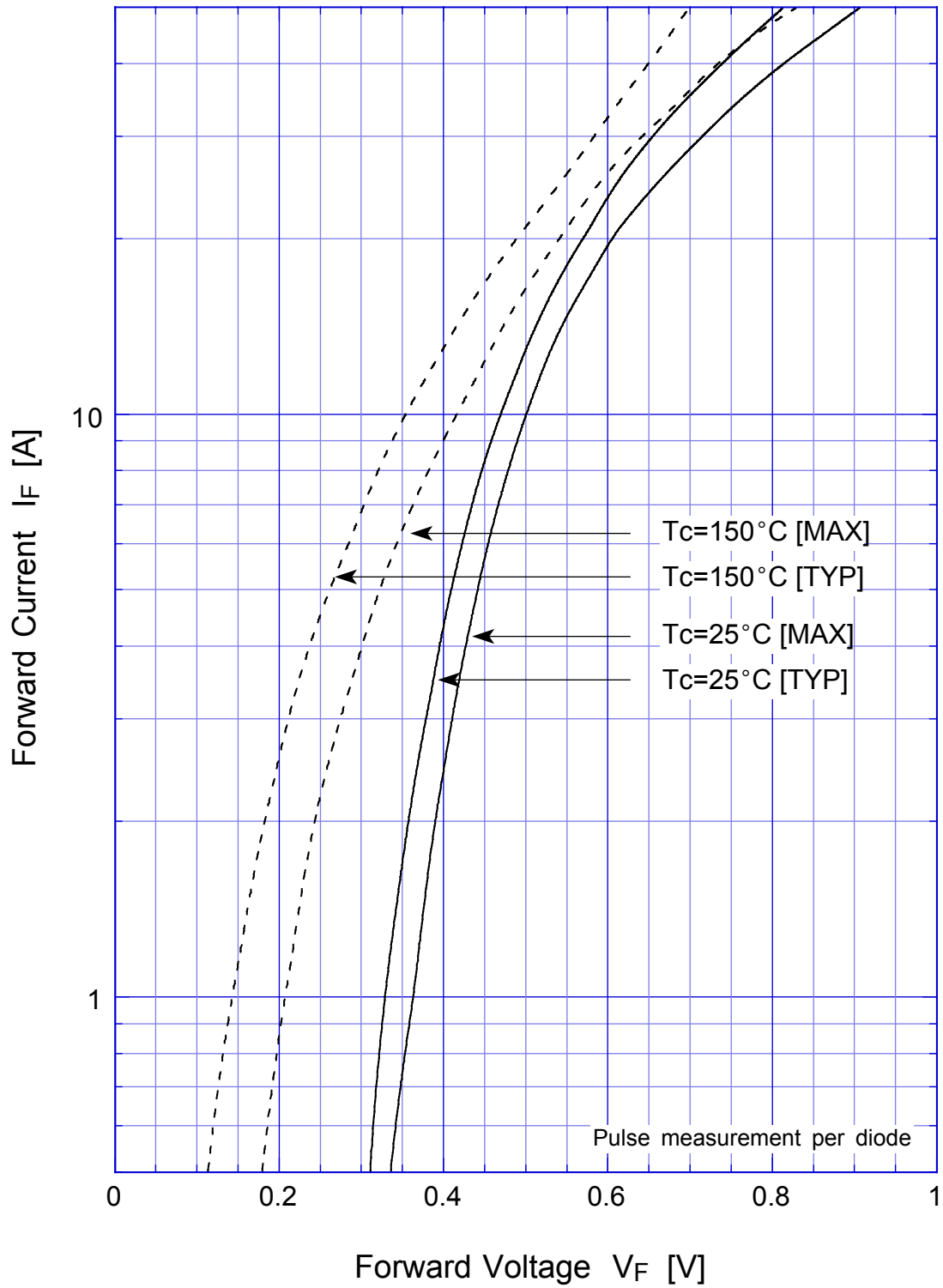

# DF30SC4M Junction Capacitance

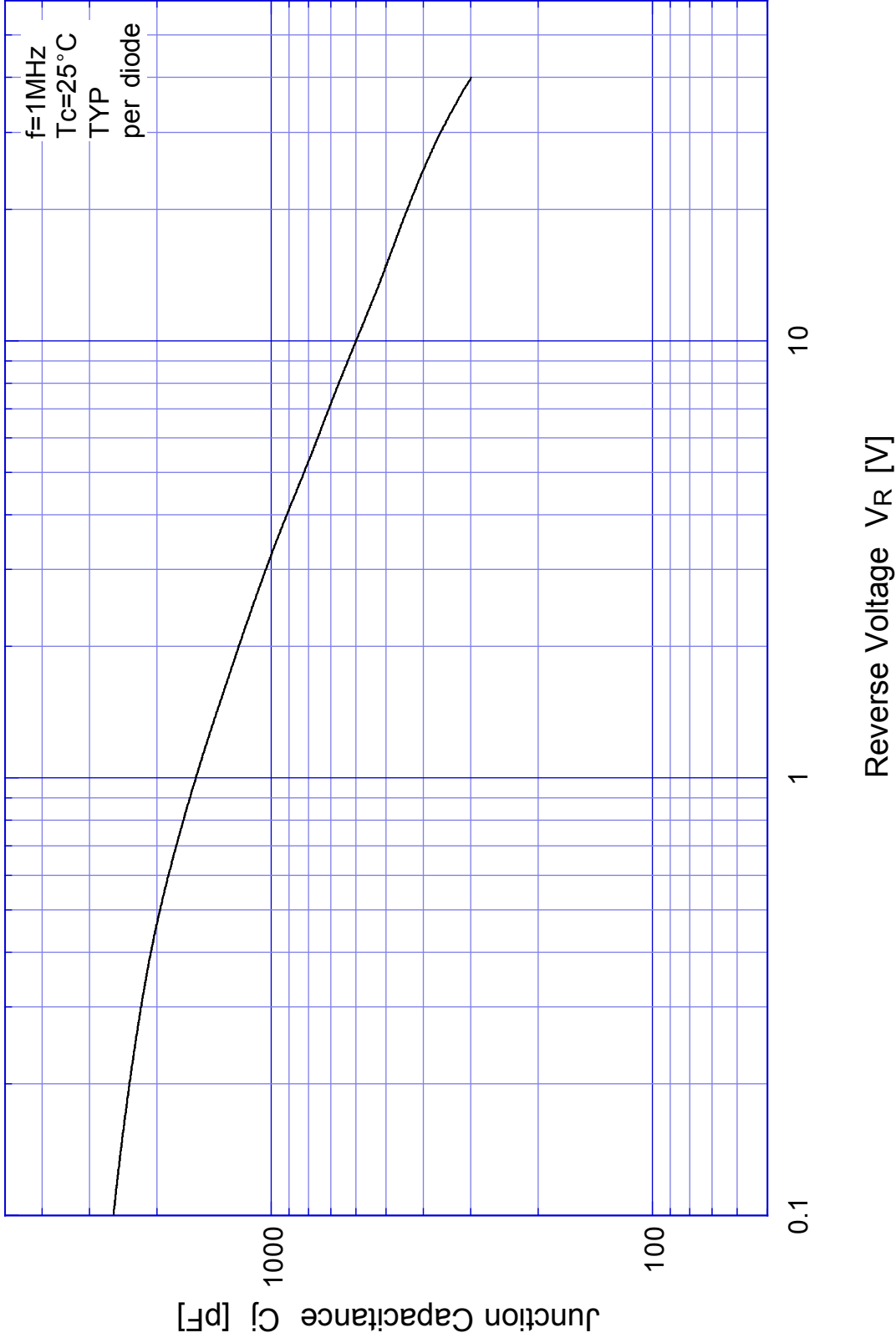

# DF30SC4M Reverse Current

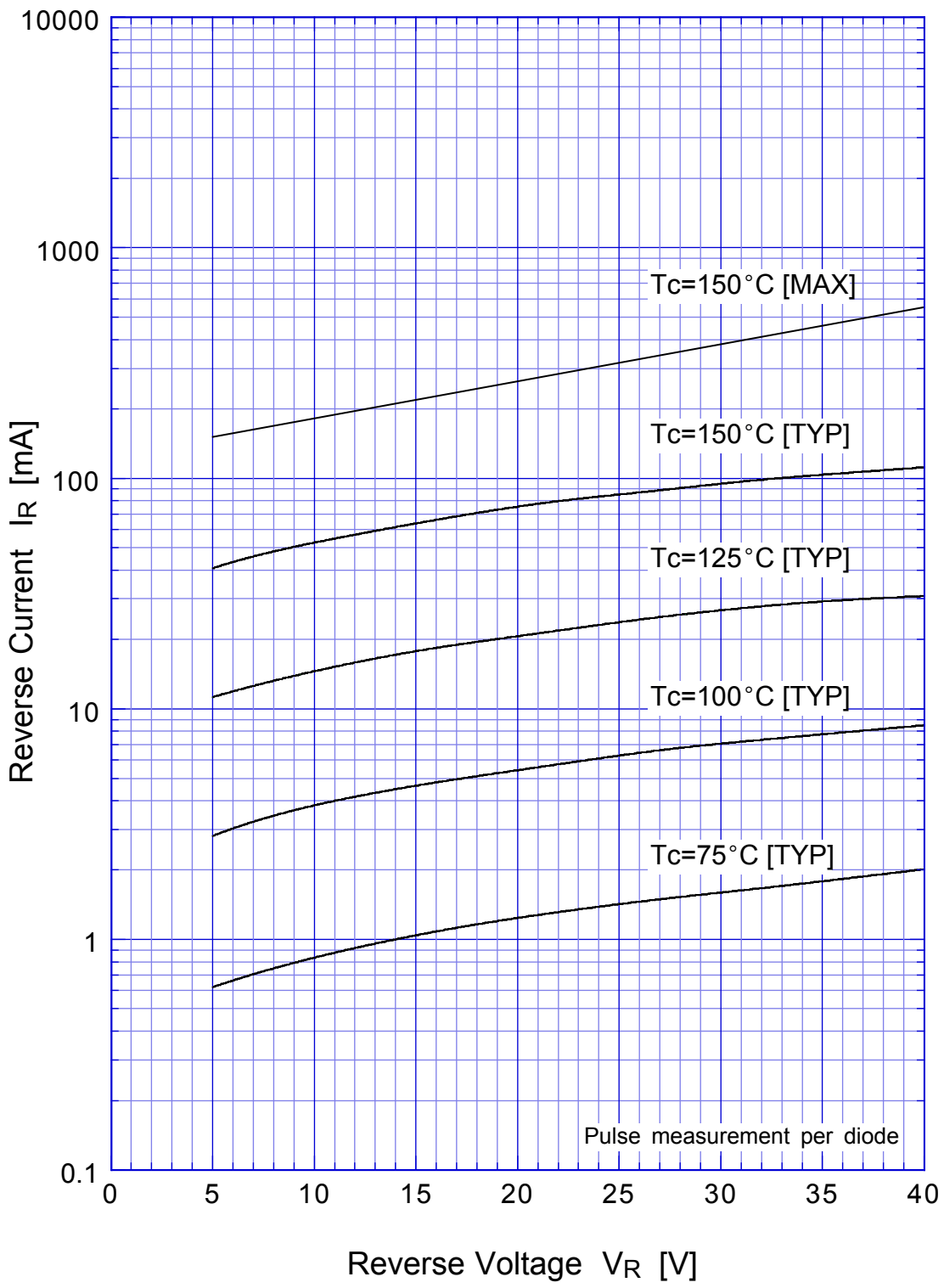

## DF30SC4M Reverse Power Dissipation

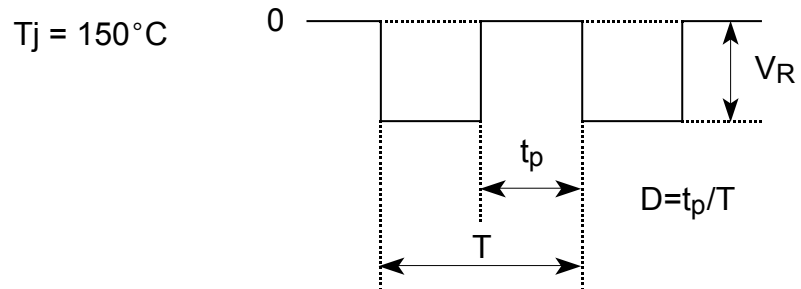
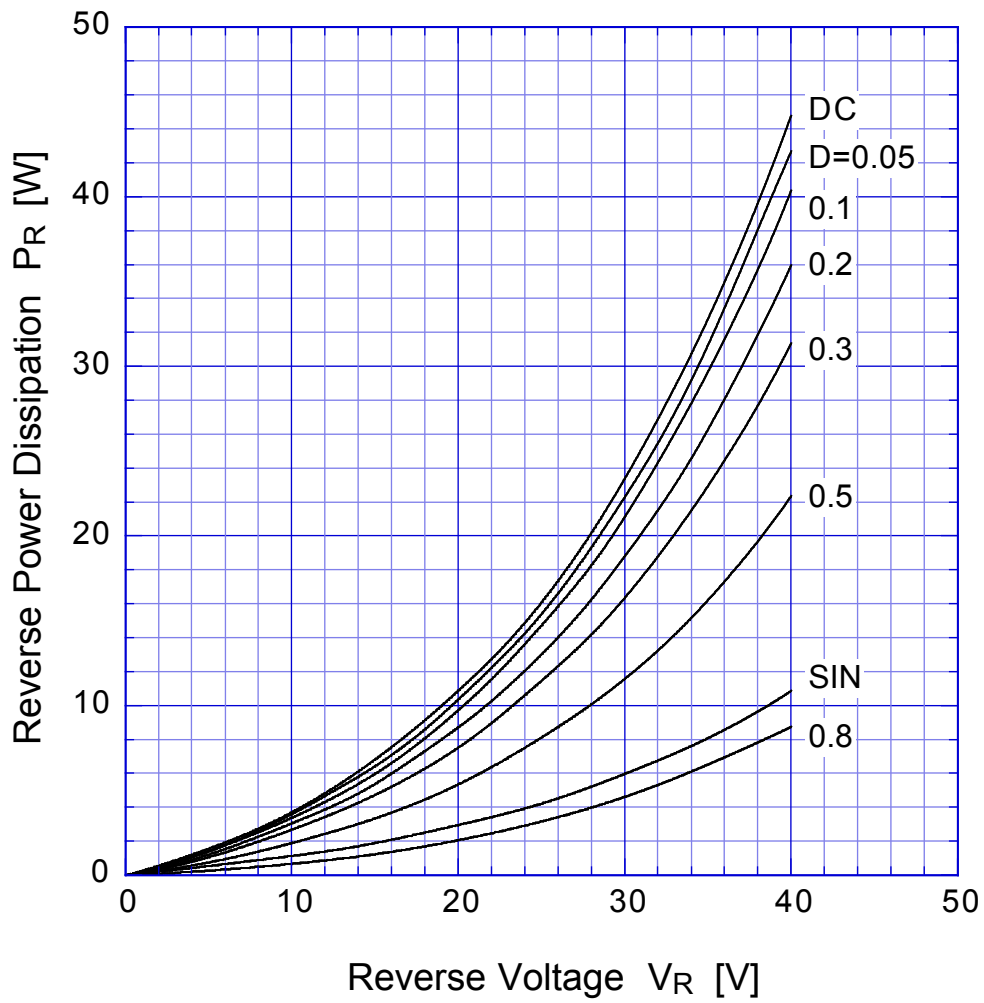

## DF30SC4M Forward Power Dissipation

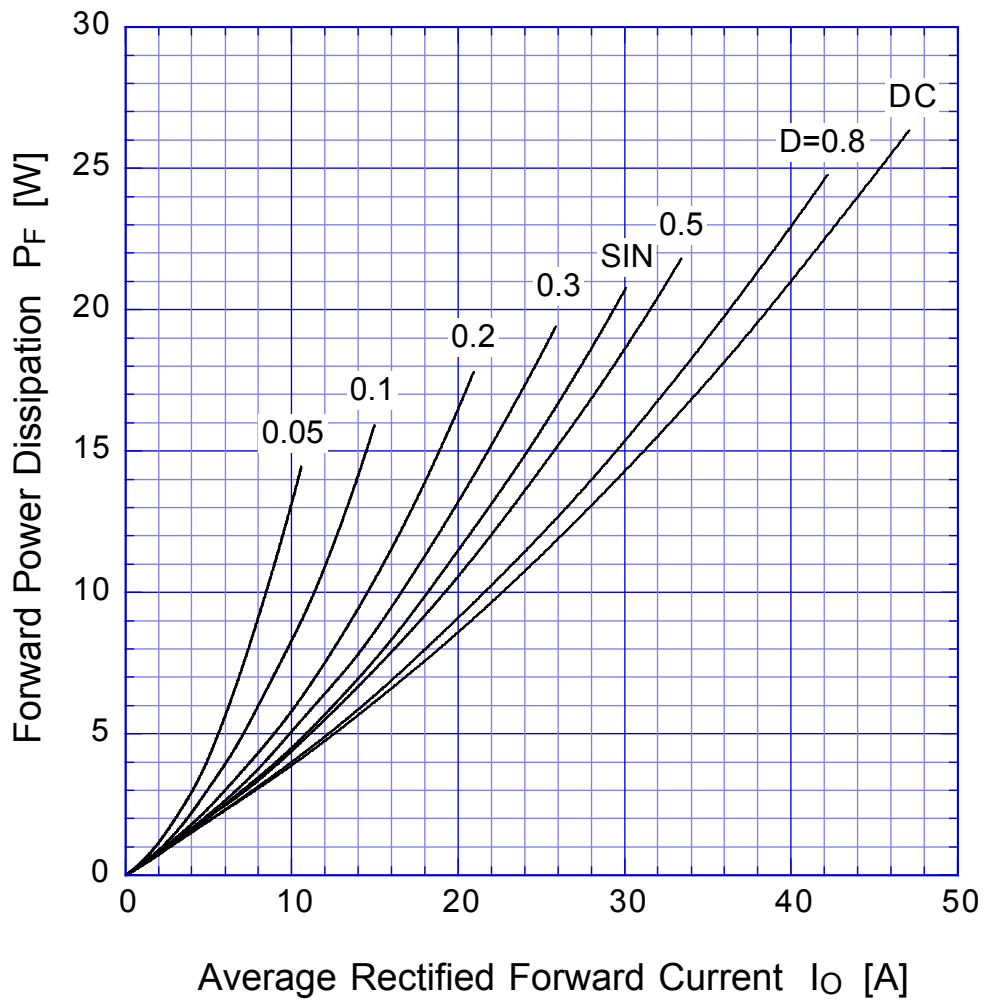

$T_j = 150^\circ\text{C}$



# DF30SC4M

# Derating Curve

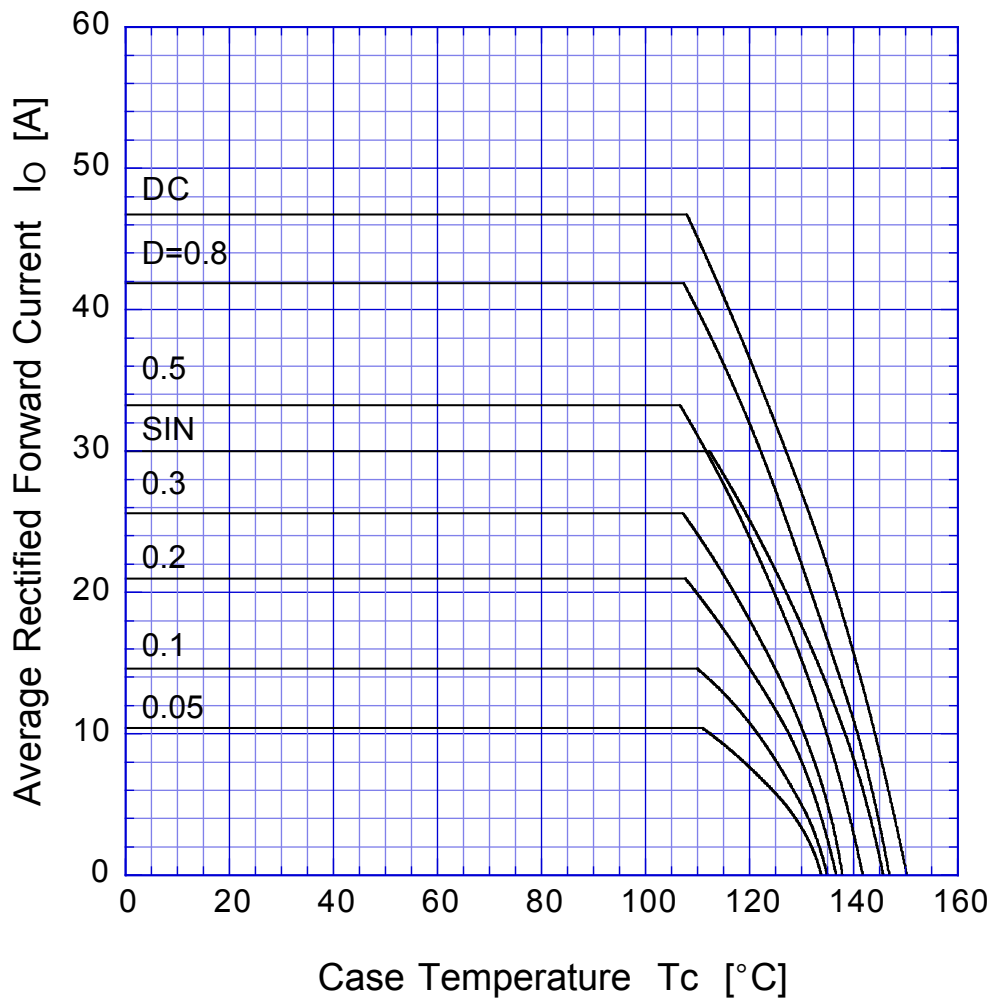

$V_R = 20V$



# DF30SC4M Peak Surge Forward Capability

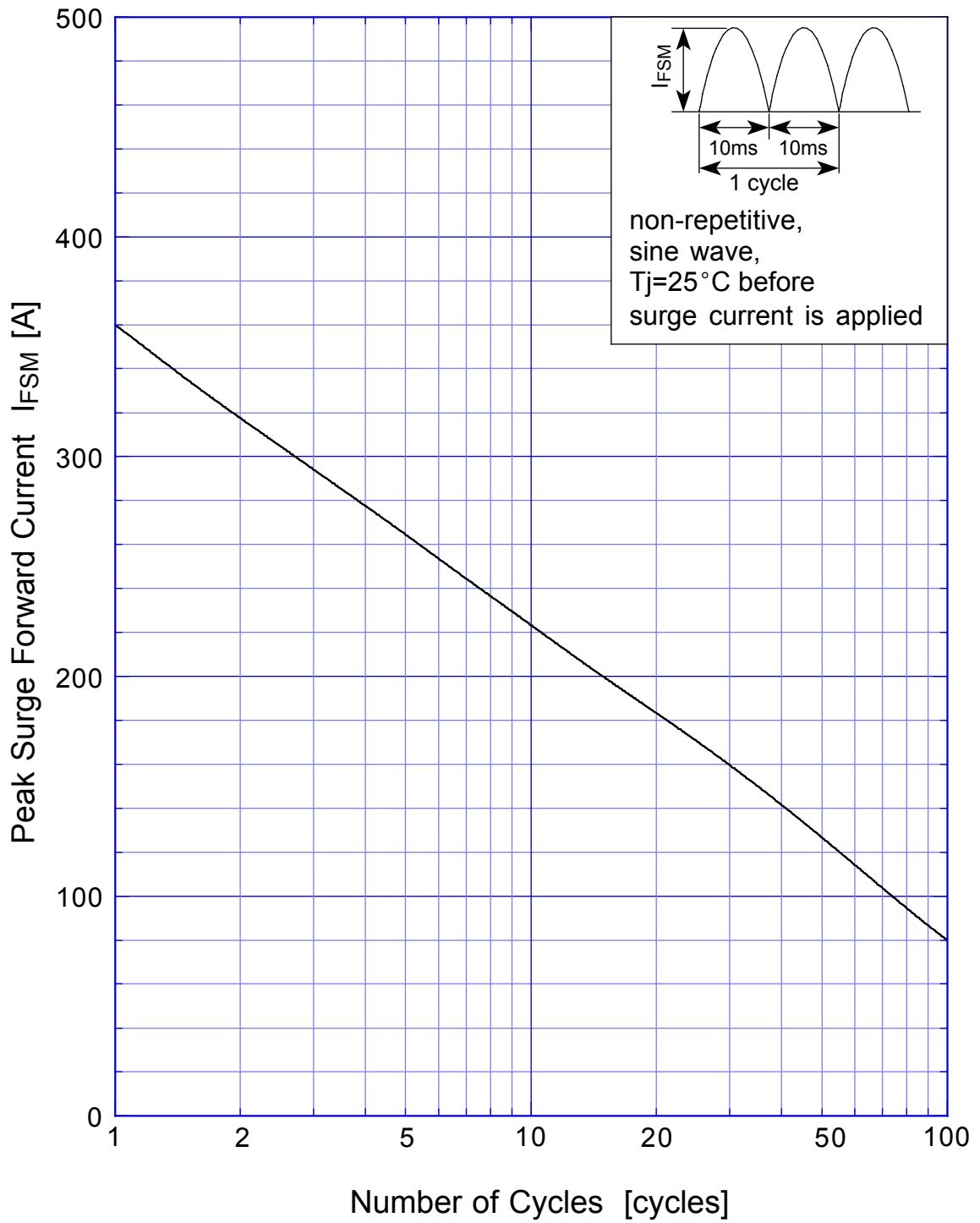



# SBD Repetitive Surge Reverse Power Derating Curve

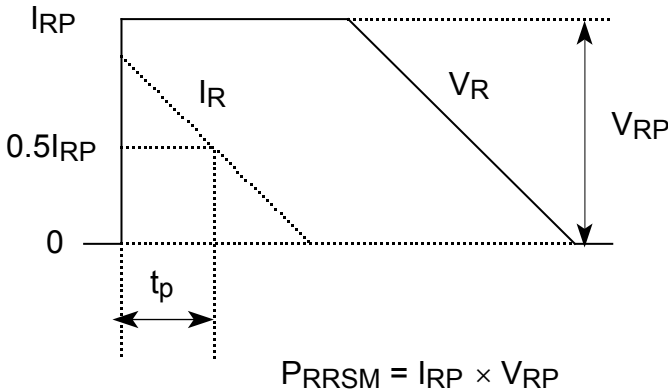

# SBD

## Repetitive Surge Reverse Power Capability

