

SHINDENGEN

Super Fast Recovery Rectifiers

Single

DF10L60

600V 10A

FEATURES

SMT
High Voltage
trr50ns

APPLICATION

PFC
Switching power supply
Free Wheel
Home Appliances, Office Equipment,
Factory Automation

OUTLINE DIMENSIONS

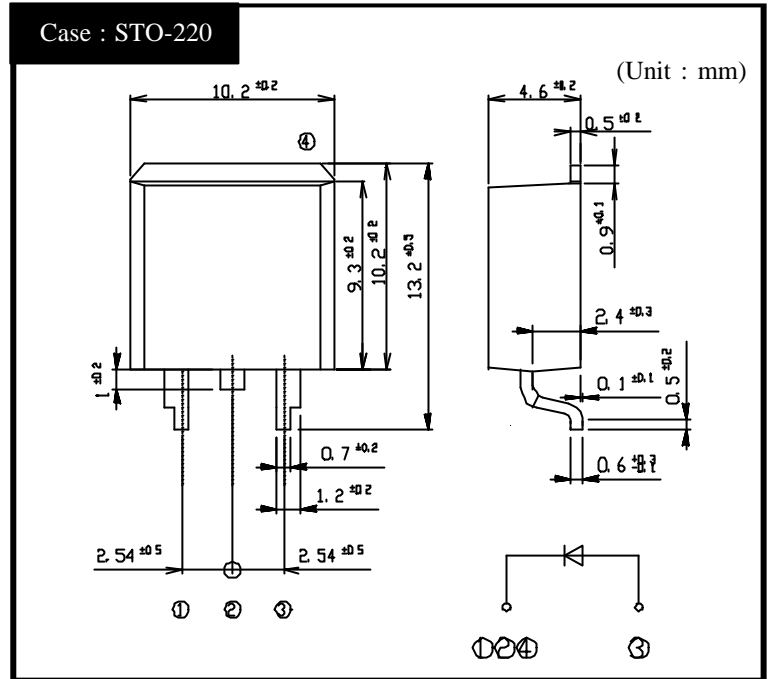

RATINGS

Absolute Maximum Ratings (If not specified Tc=25)

Item	Symbol	Conditions	Ratings	Unit
Storage Temperature	Tstg		-55 ~ 150	
Operating Junction Temperature	Tj		150	
Maximum Reverse Voltage	V _{RM}		600	V
Average Rectified Forward Current	I _O	50Hz sine wave, R-load, Tc=105	10	A
Peak Surge Forward Current	I _{FSM}	50Hz sine wave, Non-repetitive 1 cycle peak value, Tj=25	100	A

Electrical Characteristics (If not specified Tc=25)

Item	Symbol	Conditions	Ratings	Unit
Forward Voltage	V _F	I _F =10A, Pulse measurement	Max.1.9	V
Reverse Current	I _R	V _R =V _{RM} , Pulse measurement	Max.10	μA
Reverse Recovery Time	t _{rr}	I _F =0.5A, I _R =1A	Max.50	ns
Thermal Resistance	θ _{JC}	junction to case	Max.2	/W

DF10L60

Forward Voltage

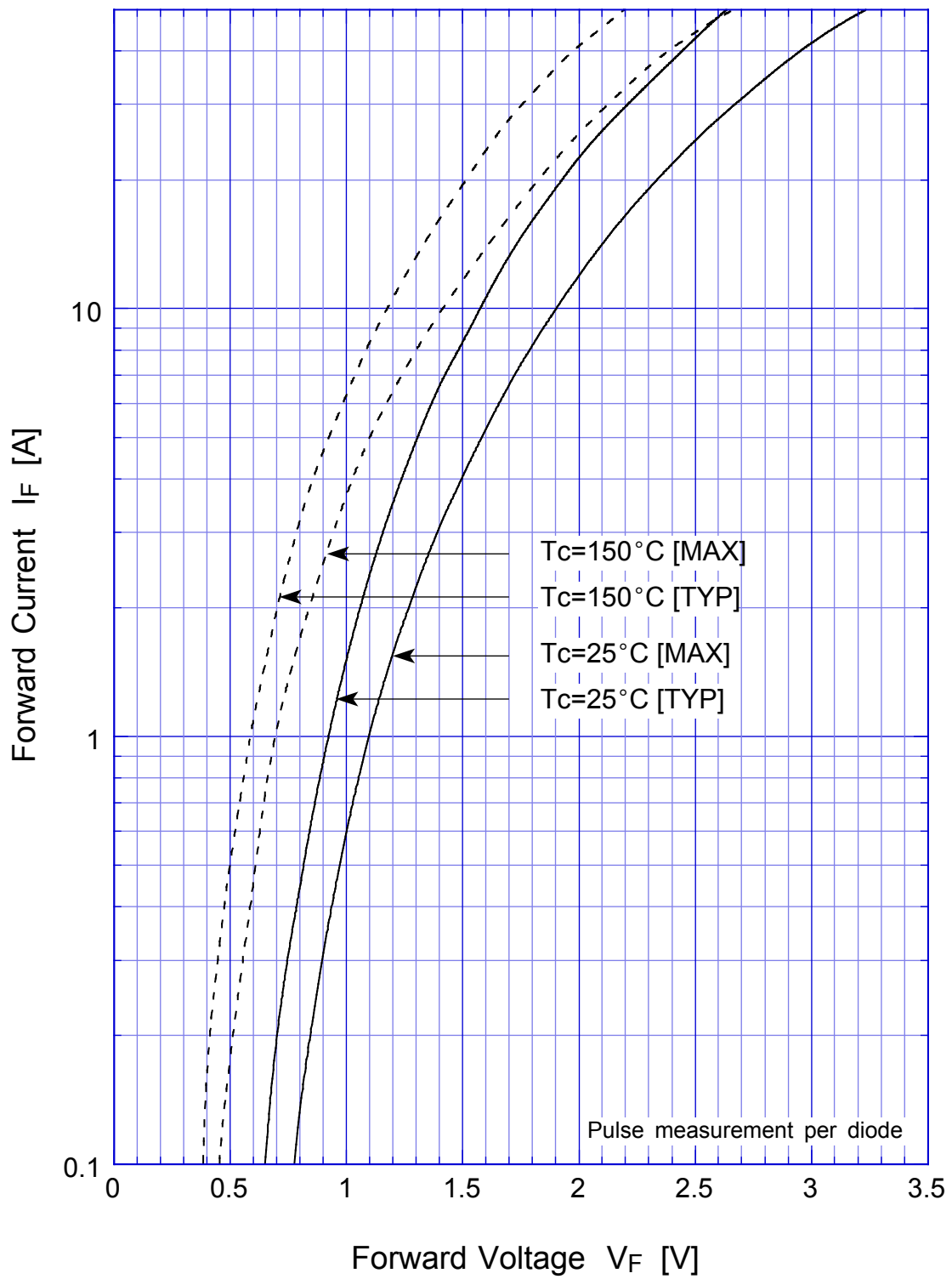

DF10L60 Forward Power Dissipation

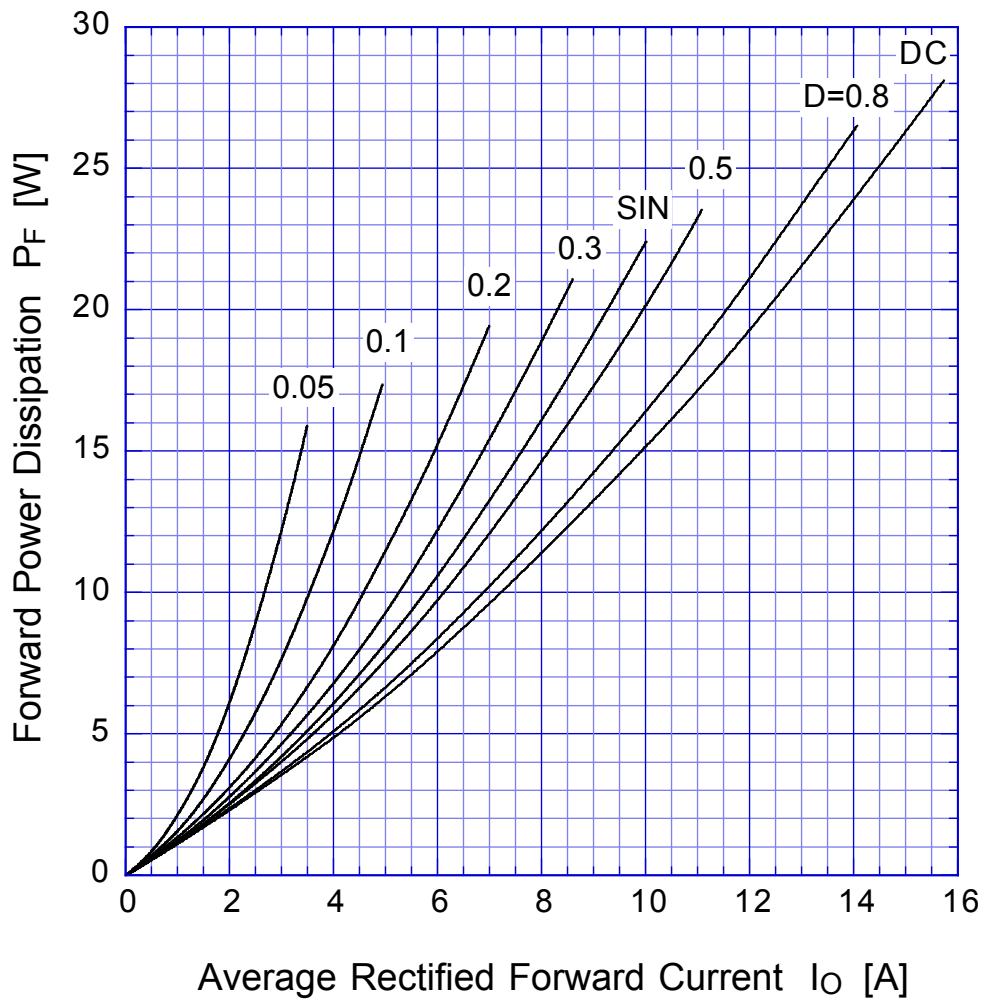

$T_j = 150^\circ\text{C}$

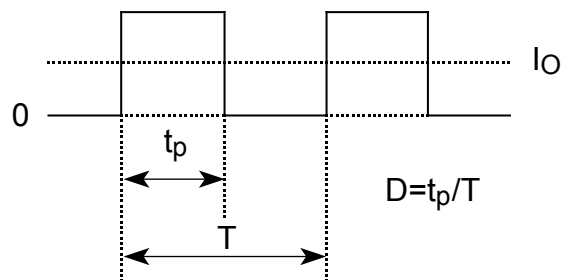

DF10L60

Derating Curve

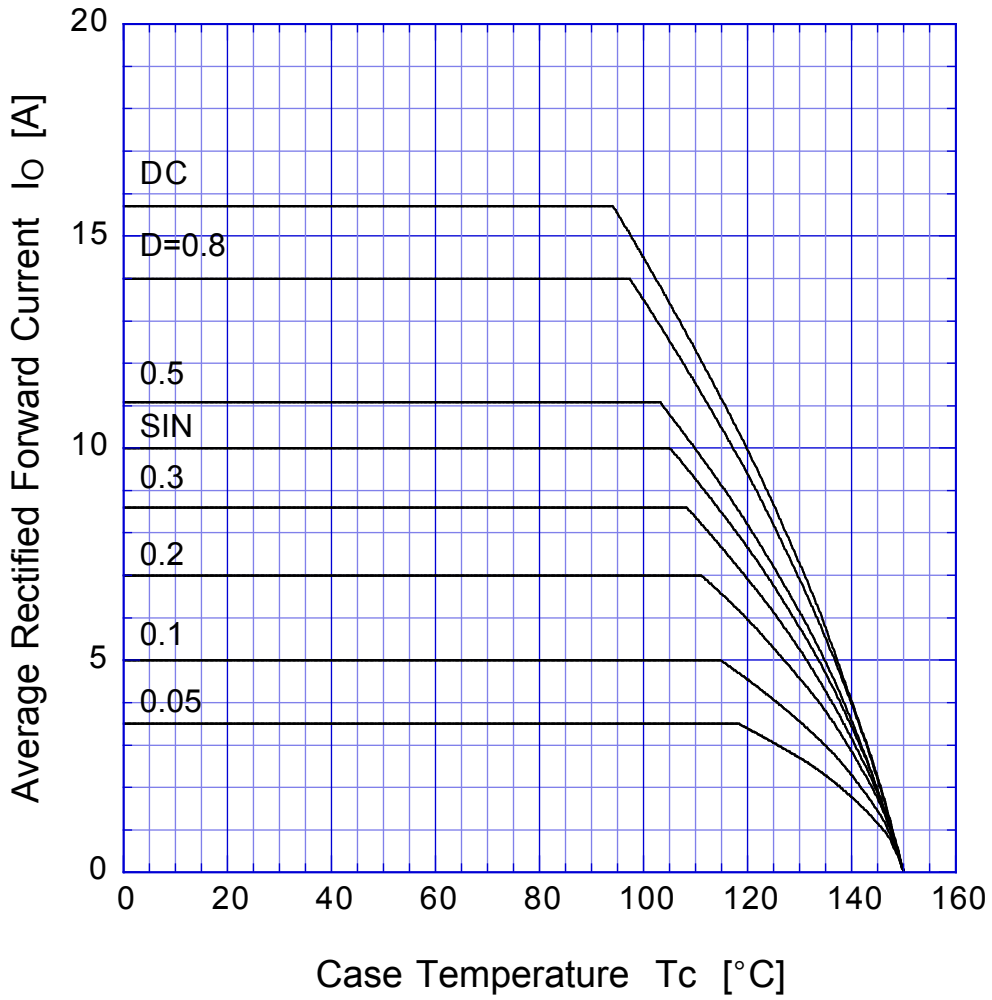

$$V_R = V_{RM}$$

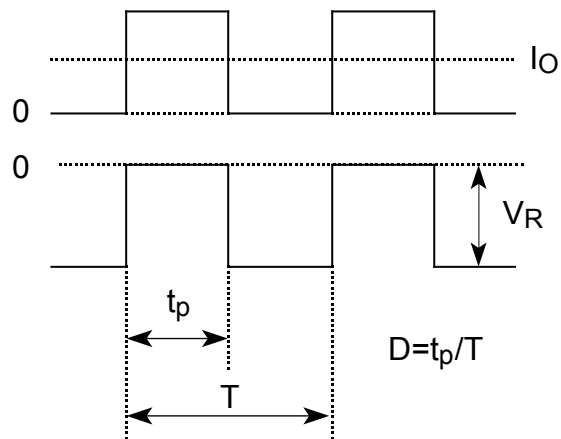

DF10L60

Peak Surge Forward Capability

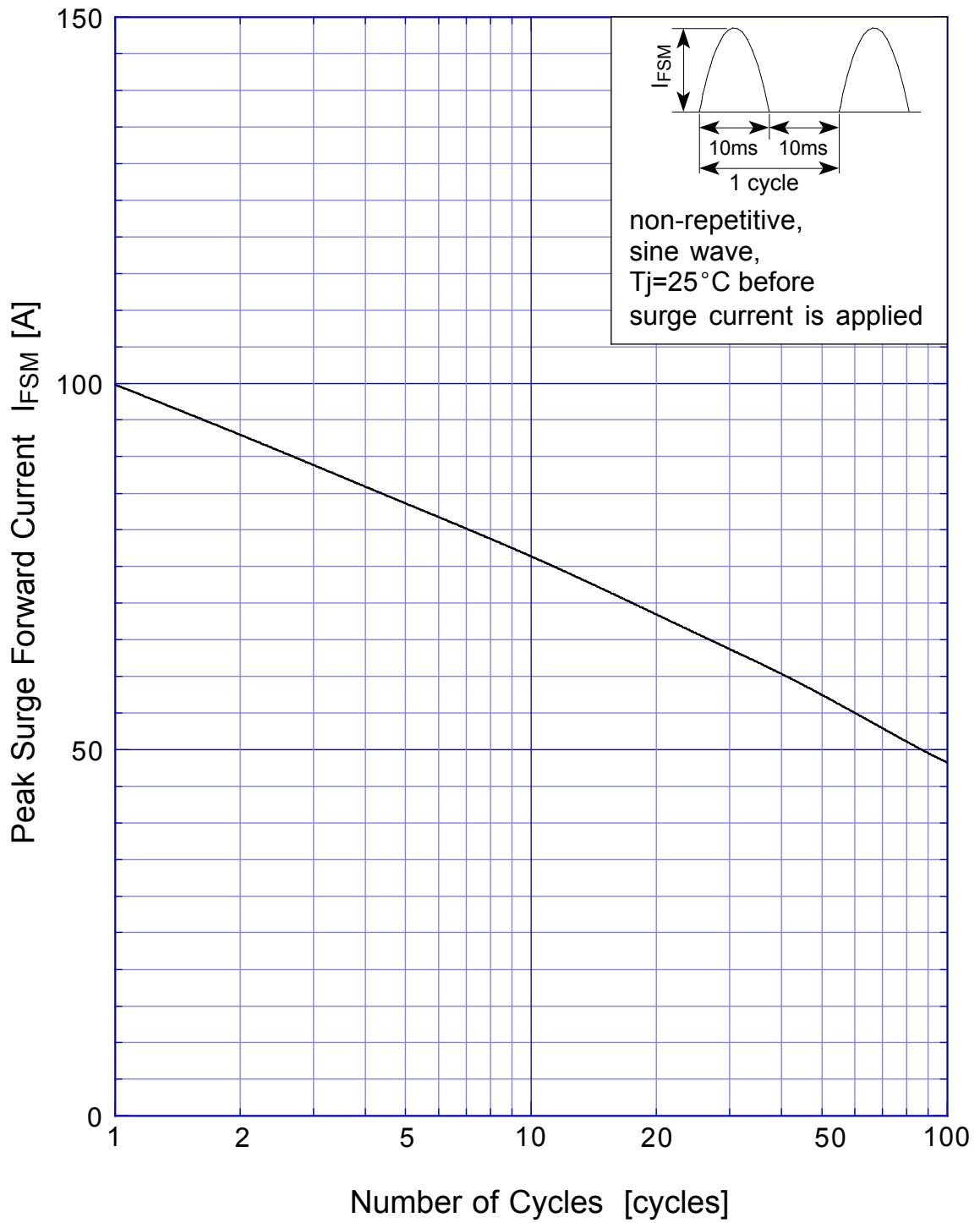

DF10L60 Junction Capacitance

