

TOSHIBA DIODE SILICON EPITAXIAL PLANAR TYPE

1SS301

ULTRA HIGH SPEED SWITCHING APPLICATIONS.

Unit in mm

- Small Package : SC-70
- Low Forward Voltage : $V_F(3) = 0.90V$ (Typ.)
- Fast Reverse Recovery Time : $t_{rr} = 1.6ns$ (Typ.)
- Small Total Capacitance : $C_T = 0.9pF$ (Typ.)

MAXIMUM RATINGS ($T_a = 25^\circ C$)

CHARACTERISTIC	SYMBOL	RATING	UNIT
Maximum (Peak) Reverse Voltage	V_{RM}	85	V
Reverse Voltage	V_R	80	V
Maximum (Peak) Forward Current	I_{FM}	300 (*)	mA
Average Forward Current	I_O	100 (*)	mA
Surge Current (10ms)	I_{FSM}	2 (*)	A
Power Dissipation	P	100	mW
Junction Temperature	T_j	125	$^\circ C$
Storage Temperature Range	T_{stg}	-55~125	$^\circ C$

(*) Unit Rating. Total Rating = Unit Rating \times 1.5

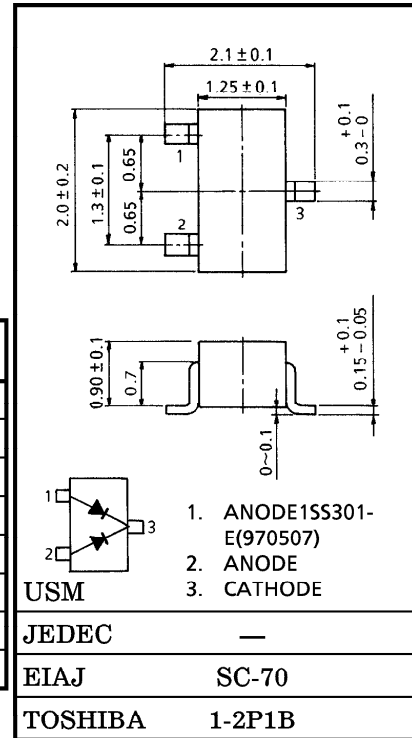

ELECTRICAL CHARACTERISTICS ($T_a = 25^\circ C$)

Weight : 0.006g

CHARACTERISTIC	SYMBOL	TEST CONDITION	MIN.	TYP.	MAX.	UNIT
Forward Voltage	$V_F(1)$	$I_F = 1mA$	—	0.60	—	V
	$V_F(2)$	$I_F = 10mA$	—	0.72	—	
	$V_F(3)$	$I_F = 100mA$	—	0.90	1.20	
Reverse Current	$I_R(1)$	$V_R = 30V$	—	—	0.1	μA
	$I_R(2)$	$V_R = 80V$	—	—	0.5	
Total Capacitance	C_T	$V_R = 0, f = 1MHz$	—	0.9	3.0	pF
Reverse Recovery Time	t_{rr}	$I_F = 10mA, Fig.1$	—	1.6	4.0	ns

Fig.1 REVERSE RECOVERY TIME (t_{rr}) TEST CIRCUIT

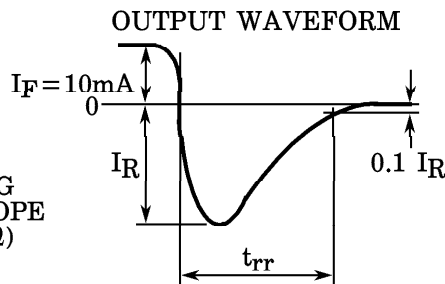
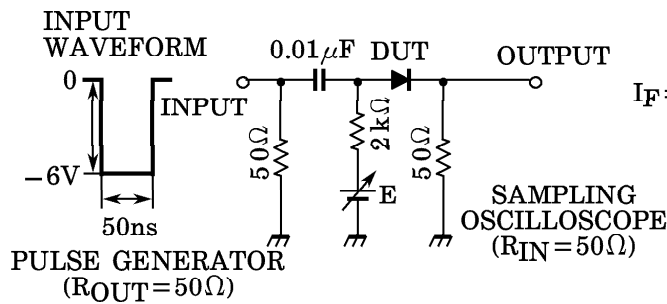

MARKING

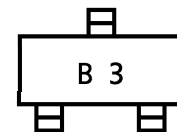

961001EAA2

● TOSHIBA is continually working to improve the quality and the reliability of its products. Nevertheless, semiconductor devices in general can malfunction or fail due to their inherent electrical sensitivity and vulnerability to physical stress. It is the responsibility of the buyer, when utilizing TOSHIBA products, to observe standards of safety, and to avoid situations in which a malfunction or failure of a TOSHIBA product could cause loss of human life, bodily injury or damage to property. In developing your designs, please ensure that TOSHIBA products are used within specified operating ranges as set forth in the most recent products specifications. Also, please keep in mind the precautions and conditions set forth in the TOSHIBA Semiconductor Reliability Handbook.

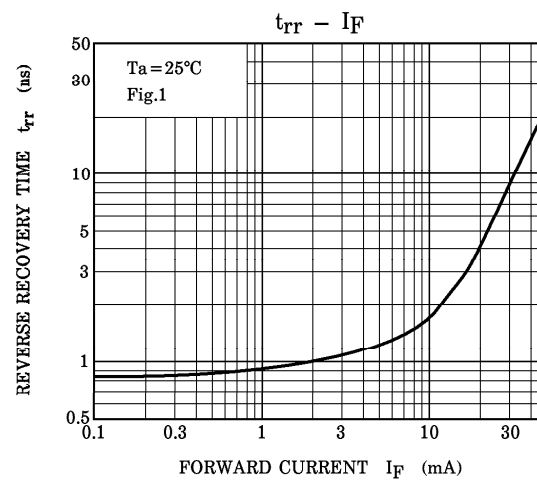
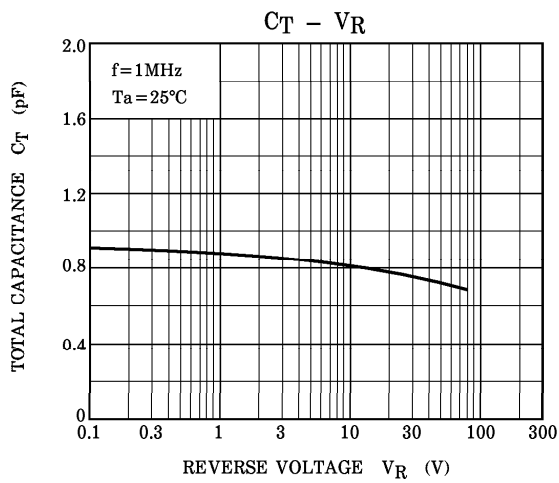
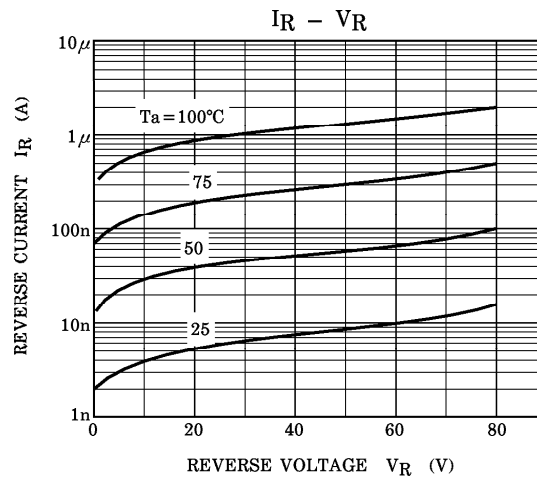
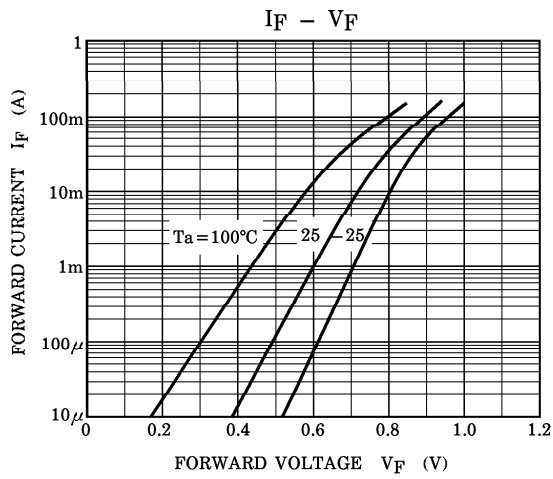

961001EAA2'

- The information contained herein is presented only as a guide for the applications of our products. No responsibility is assumed by TOSHIBA CORPORATION for any infringements of intellectual property or other rights of the third parties which may result from its use. No license is granted by implication or otherwise under any intellectual property or other rights of TOSHIBA CORPORATION or others.
- The information contained herein is subject to change without notice.