

# DATA SHEET

# NEC

## NPN SILICON RF TRANSISTOR 2SC5754

### NPN SILICON RF TRANSISTOR FOR MEDIUM OUTPUT POWER AMPLIFICATION (0.4 W) FLAT-LEAD 4-PIN THIN-TYPE SUPER MINIMOLD (M04)

#### FEATURES

- Ideal for 460 MHz to 2.4 GHz medium output power amplification
- $P_{O(1\text{ dB})} = 26.0\text{ dBm TYP. @ } V_{CE} = 3.6\text{ V, } f = 1.8\text{ GHz, } P_{in} = 15\text{ dBm}$
- High collector efficiency:  $\eta_C = 60\%$
- UHS0-HV technology ( $f_T = 25\text{ GHz}$ ) adopted
- High reliability through use of gold electrodes
- Flat-lead 4-pin thin-type super minimold (M04) package

#### ORDERING INFORMATION

Part Number	Quantity	Supplying Form
2SC5754	50 pcs (Non reel)	• 8 mm wide embossed taping
2SC5754-T2	3 kpcs/reel	• Pin 1 (Emitter), Pin 2 (Collector) face the perforation side of the tape

**Remark** To order evaluation samples, contact your nearby sales office.  
The unit sample quantity is 50 pcs.

**Caution** Observe precautions when handling because these devices are sensitive to electrostatic discharge.

The information in this document is subject to change without notice. Before using this document, please confirm that this is the latest version.  
Not all devices/types available in every country. Please check with local NEC Compound Semiconductor Devices representative for availability and additional information.

**ABSOLUTE MAXIMUM RATINGS (T<sub>A</sub> = +25°C)**

Parameter	Symbol	Ratings	Unit
Collector to Base Voltage	V <sub>CB0</sub>	13	V
Collector to Emitter Voltage	V <sub>CE0</sub>	5.0	V
Emitter to Base Voltage	V <sub>EB0</sub>	1.5	V
Collector Current	I <sub>c</sub>	500	mA
Total Power Dissipation	P <sub>tot</sub> <sup>Note</sup>	735	mW
Junction Temperature	T <sub>j</sub>	150	°C
Storage Temperature	T <sub>stg</sub>	-65 to +150	°C

**Note** Mounted on 38 × 38 mm, t = 0.4 mm polyimide PCB

**THERMAL RESISTANCE**

Parameter	Symbol	Test Conditions	Ratings	Unit
★ Junction to Ambient Resistance	R <sub>th j-a1</sub>	Mounted on 38 × 38 mm, t = 0.4 mm polyimide PCB	170	°C/W
	R <sub>th j-a2</sub>	Stand alone device in free air	570	°C/W

**ELECTRICAL CHARACTERISTICS (T<sub>A</sub> = +25°C)**

Parameter	Symbol	Test Conditions	MIN.	TYP.	MAX.	Unit
DC Characteristics						
Collector Cut-off Current	I <sub>CBO</sub>	V <sub>CB</sub> = 5 V, I <sub>E</sub> = 0 mA	–	–	1 000	nA
Emitter Cut-off Current	I <sub>EBO</sub>	V <sub>BE</sub> = 1 V, I <sub>C</sub> = 0 mA	–	–	1 000	nA
DC Current Gain	h <sub>FE</sub> <sup>Note 1</sup>	V <sub>CE</sub> = 3 V, I <sub>C</sub> = 100 mA	40	60	100	–
RF Characteristics						
Gain Bandwidth Product	f <sub>T</sub>	V <sub>CE</sub> = 3 V, I <sub>C</sub> = 100 mA, f = 0.5 GHz	16	20	–	GHz
Insertion Power Gain	S <sub>21e</sub>   <sup>2</sup>	V <sub>CE</sub> = 3 V, I <sub>C</sub> = 100 mA, f = 2 GHz	5.0	6.5	–	dB
Reverse Transfer Capacitance	C <sub>re</sub> <sup>Note 2</sup>	V <sub>CB</sub> = 3 V, I <sub>E</sub> = 0 mA, f = 1 MHz	–	1.0	1.5	pF
Maximum Available Power Gain	MAG <sup>Note 3</sup>	V <sub>CE</sub> = 3 V, I <sub>C</sub> = 100 mA, f = 2 GHz	–	12.0	–	dB
Linear Gain	G <sub>L</sub>	V <sub>CE</sub> = 3.6 V, I <sub>Cq</sub> = 20 mA, f = 1.8 GHz, P <sub>in</sub> = 0 dBm, 1/2 Duty	–	12.0	–	dB
Gain 1 dB Compression Output Power	P <sub>O</sub> (1 dB)	V <sub>CE</sub> = 3.6 V, I <sub>Cq</sub> = 4 mA, f = 1.8 GHz, P <sub>in</sub> = 15 dBm, 1/2 Duty	–	26.0	–	dBm
Collector Efficiency	η <sub>C</sub>	V <sub>CE</sub> = 3.6 V, I <sub>Cq</sub> = 4 mA, f = 1.8 GHz, P <sub>in</sub> = 15 dBm, 1/2 Duty	–	60	–	%

- Notes**
1. Pulse measurement: PW ≤ 350 μs, Duty Cycle ≤ 2%
  2. Collector to base capacitance when the emitter grounded

$$3. \text{MAG} = \left| \frac{S_{21}}{S_{12}} \right| (K - \sqrt{K^2 - 1})$$

**h<sub>FE</sub> CLASSIFICATION**

Rank	FB
Marking	R57
h <sub>FE</sub> Value	40 to 100

TYPICAL CHARACTERISTICS (Unless otherwise specified,  $T_A = +25^\circ\text{C}$ )

TOTAL POWER DISSIPATION vs. AMBIENT TEMPERATURE

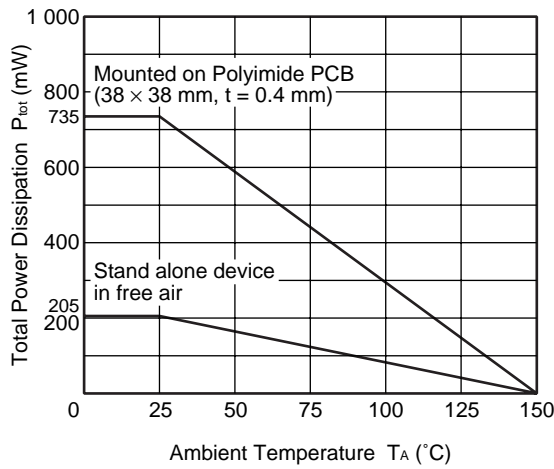

REVERSE TRANSFER CAPACITANCE vs. COLLECTOR TO BASE VOLTAGE

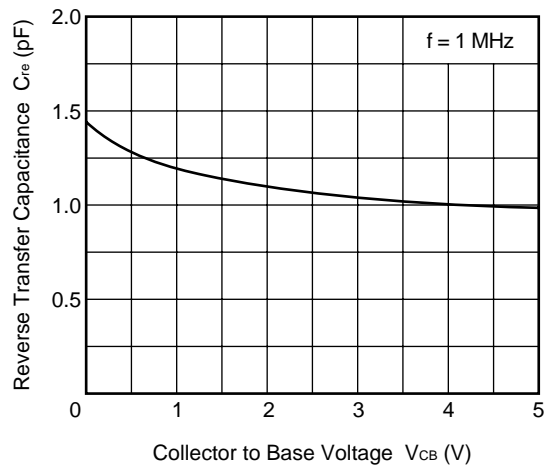

COLLECTOR CURRENT vs. BASE TO EMITTER VOLTAGE

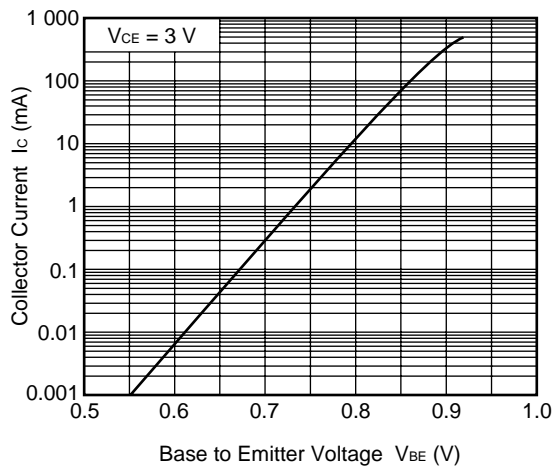

COLLECTOR CURRENT vs. COLLECTOR TO EMITTER VOLTAGE

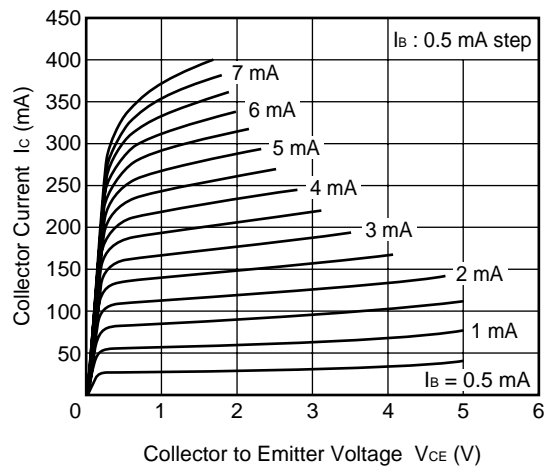

DC CURRENT GAIN vs. COLLECTOR CURRENT

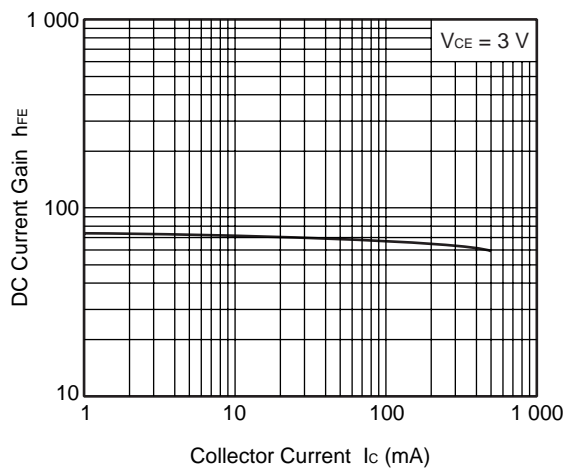

GAIN BANDWIDTH PRODUCT vs. COLLECTOR CURRENT

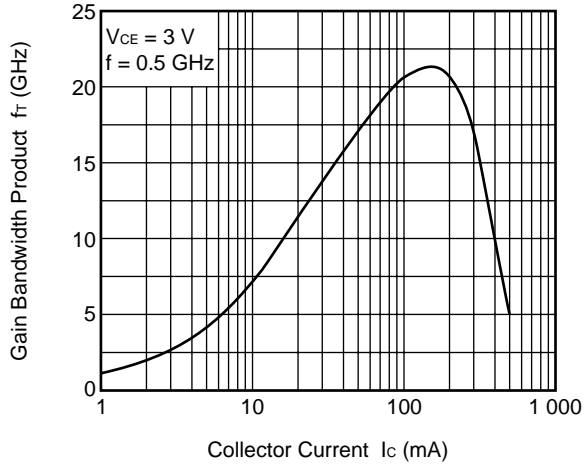

INSERTION POWER GAIN, MAG, MSG vs. FREQUENCY

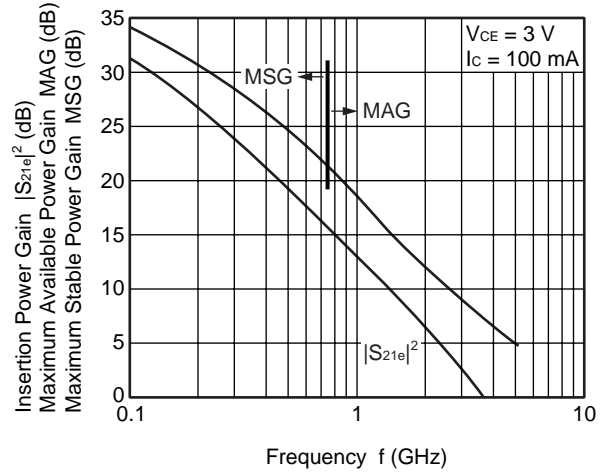

INSERTION POWER GAIN, MAG, MSG vs. COLLECTOR CURRENT

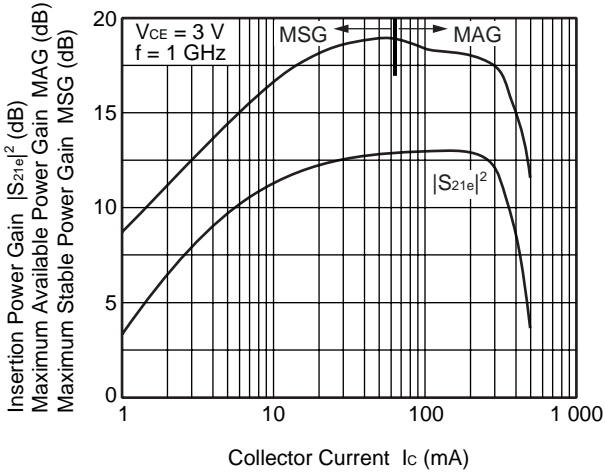

INSERTION POWER GAIN, MAG, MSG vs. COLLECTOR CURRENT

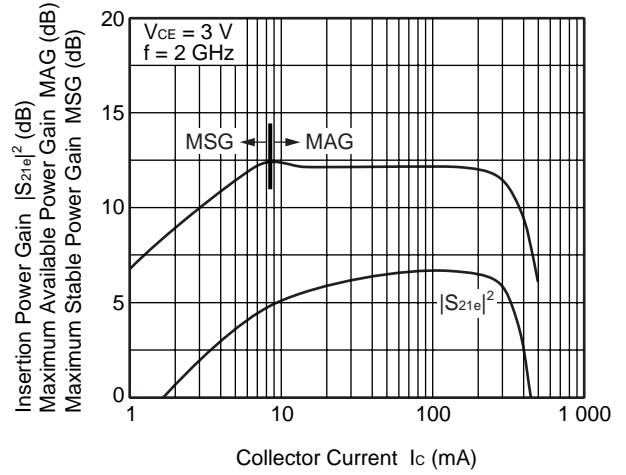

INSERTION POWER GAIN, MAG, MSG vs. COLLECTOR CURRENT

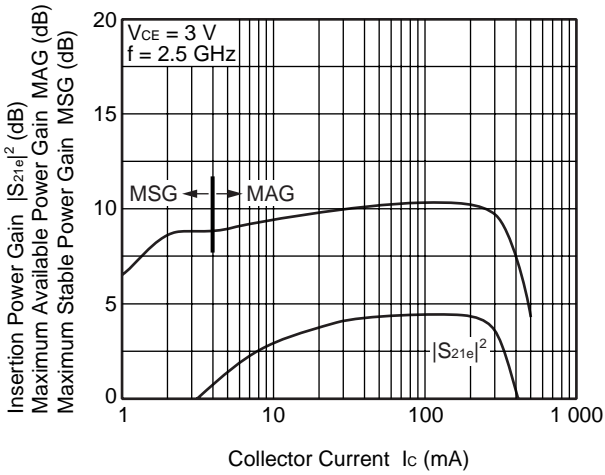

OUTPUT POWER, POWER GAIN, COLLECTOR CURRENT, COLLECTOR EFFICIENCY vs. INPUT POWER

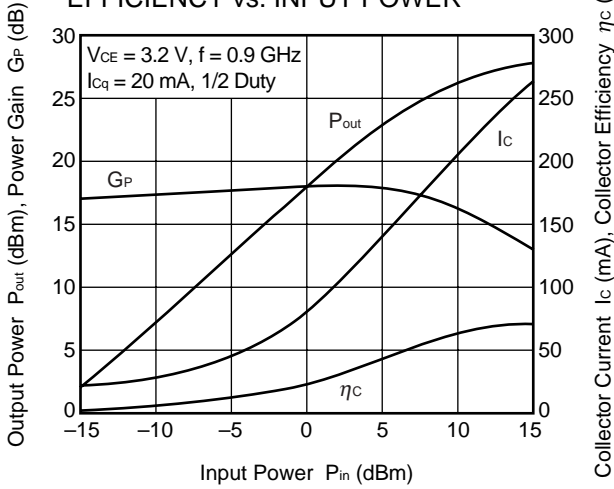

OUTPUT POWER, POWER GAIN, COLLECTOR CURRENT, COLLECTOR EFFICIENCY vs. INPUT POWER

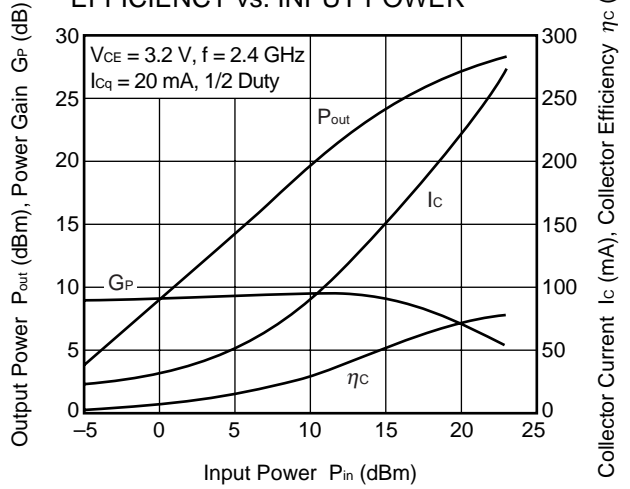

OUTPUT POWER, POWER GAIN, COLLECTOR CURRENT, COLLECTOR EFFICIENCY vs. INPUT POWER

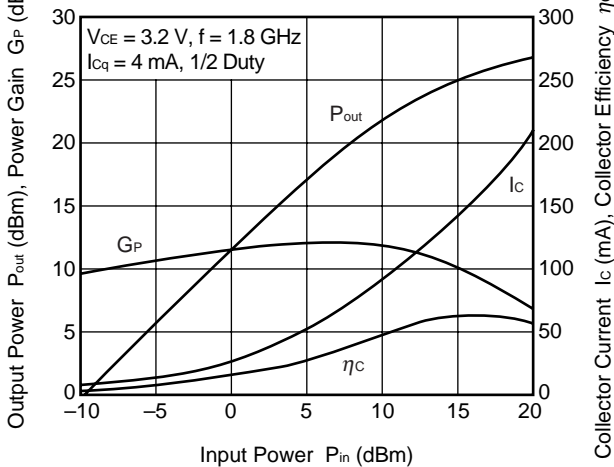

OUTPUT POWER, POWER GAIN, COLLECTOR CURRENT, COLLECTOR EFFICIENCY vs. INPUT POWER

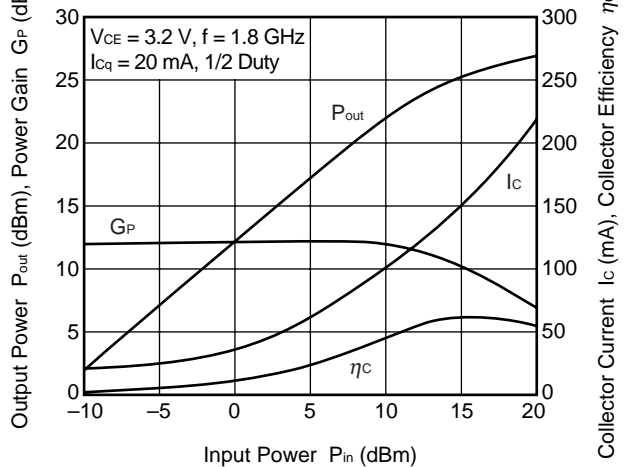

OUTPUT POWER, POWER GAIN, COLLECTOR CURRENT, COLLECTOR EFFICIENCY vs. INPUT POWER

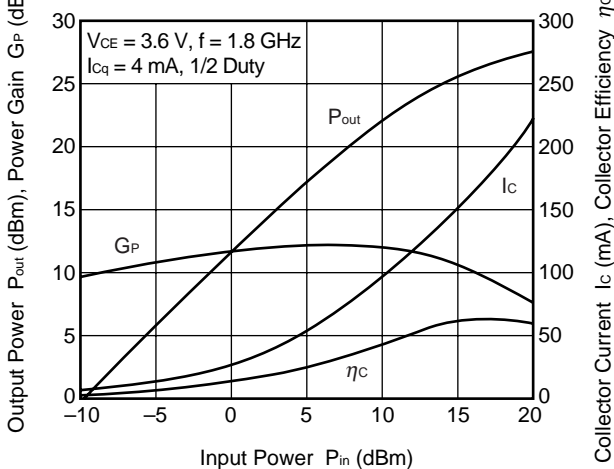

OUTPUT POWER, POWER GAIN, COLLECTOR CURRENT, COLLECTOR EFFICIENCY vs. INPUT POWER

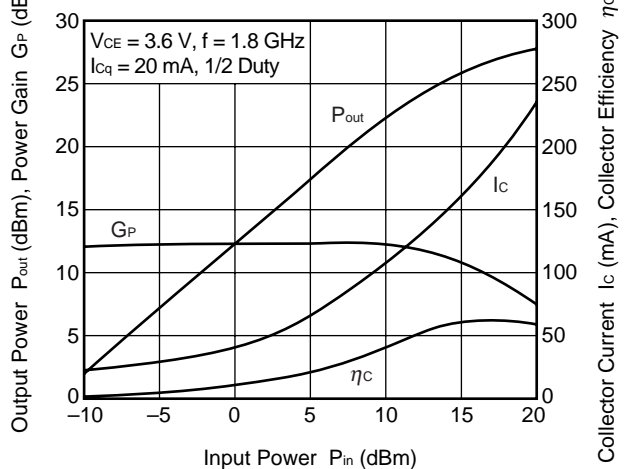

**Remark** The graphs indicate nominal characteristics.

**POWER SUPPLY IMPEDANCE, LOAD IMPEDANCE (Recommended value)**

Frequency f (GHz)	Collector to Emitter Voltage V <sub>CE</sub> (V)	Supply Impedance Z <sub>s</sub> (Ω)	Load Impedance Z <sub>L</sub> (Ω)
0.9	2.8 to 3.6	8.4 – 5.2 j	15.1 – 4.3 j
1.8	2.8 to 3.6	6.3 – 16.4 j	15.8 – 6.9 j
2.4	2.8 to 3.6	5.9 – 22.1 j	15.2 – 17.9 j

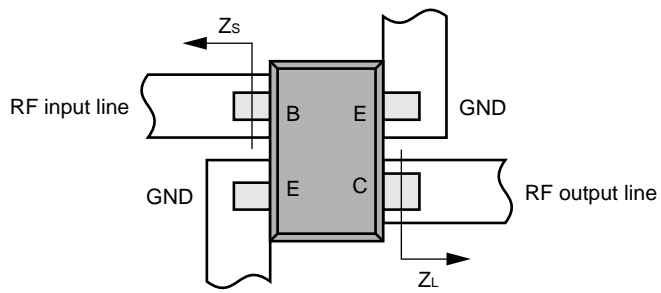
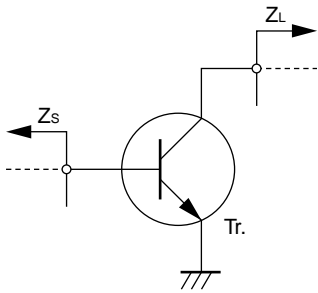

f = 0.9 GHz

f = 1.8 GHz

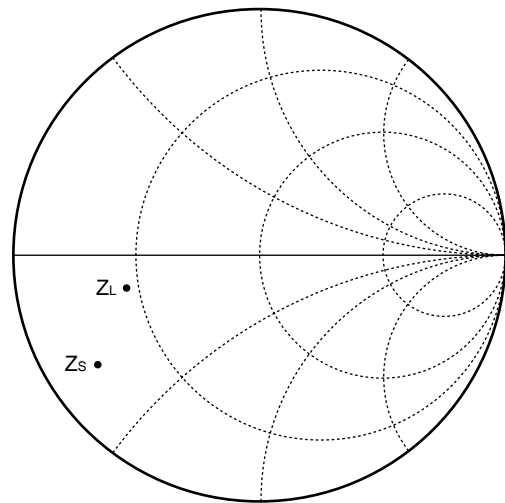
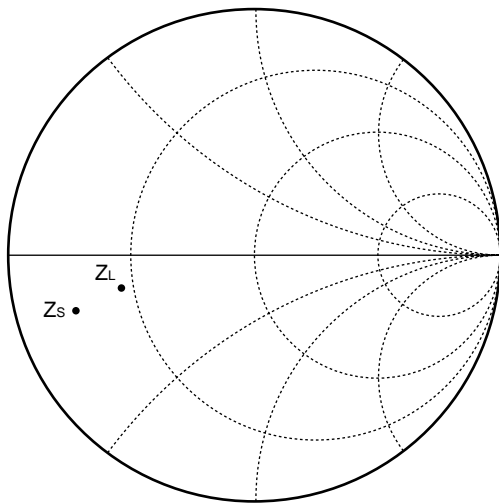

f = 2.4 GHz

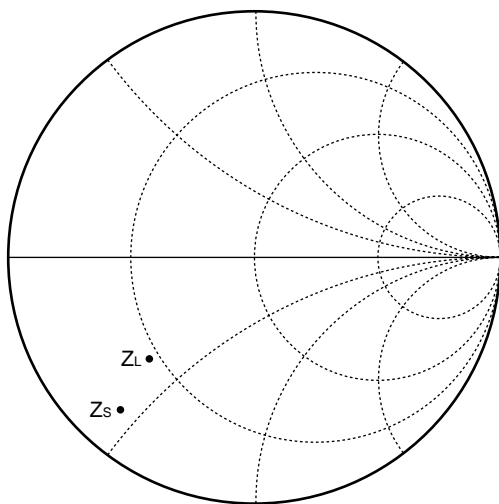

**APPLICATION EXAMPLE (Low-cost PA solution)**

Bluetooth Power Class 1  
 f = 2.4 GHz

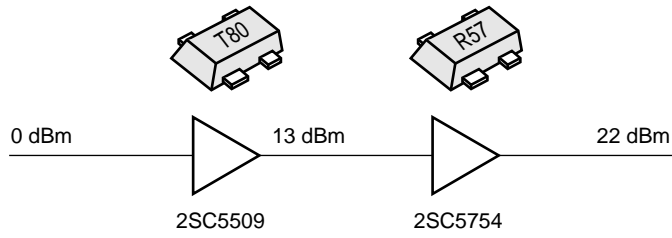

SS Cordless Phone  
 f = 2.4 GHz

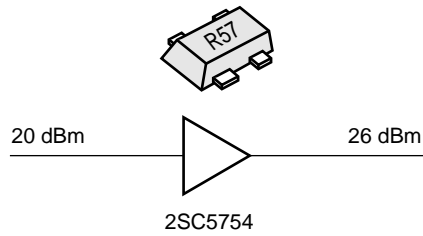

DCS1800 (GSM1800) Cellular Phone  
 f = 1.8 GHz

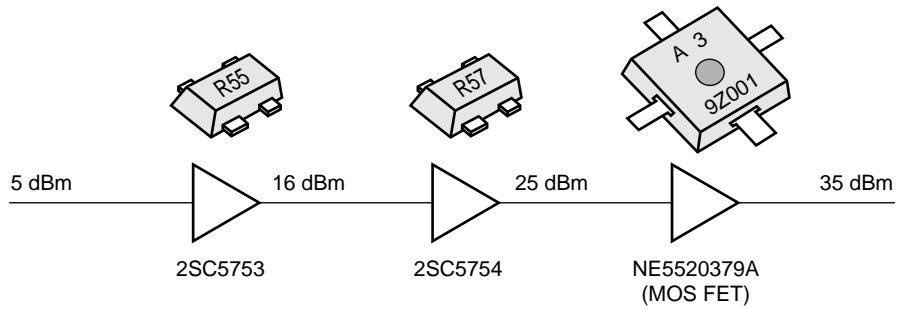

Cordless Phone  
 f = 0.9 GHz

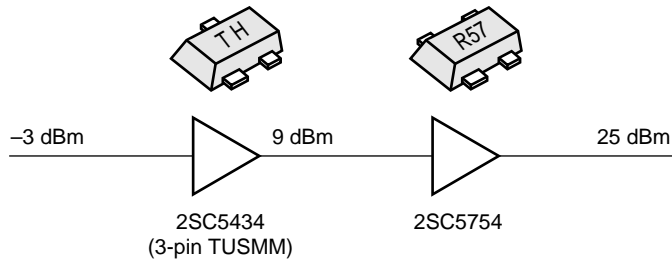



EVALUATION CIRCUIT EXAMPLE : 1.8 GHz PA EVALUATION BOARD

PCB Pattern and Element Layout

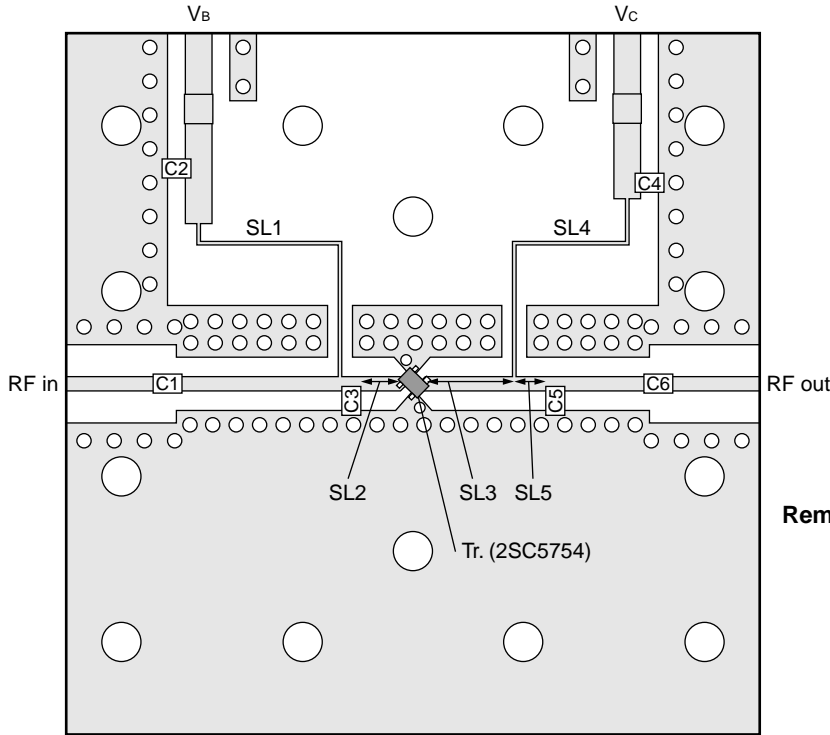

- Remarks**
1. 38 × 38 mm, t = 0.4 mm,  $\epsilon_r = 4.55$  double-sided copper-clad polyimide board
  2. Back side : GND pattern
  3. Solder plating on pattern
  4.  $\circ$   $\circ$  : Through holes

Equivalent Circuit

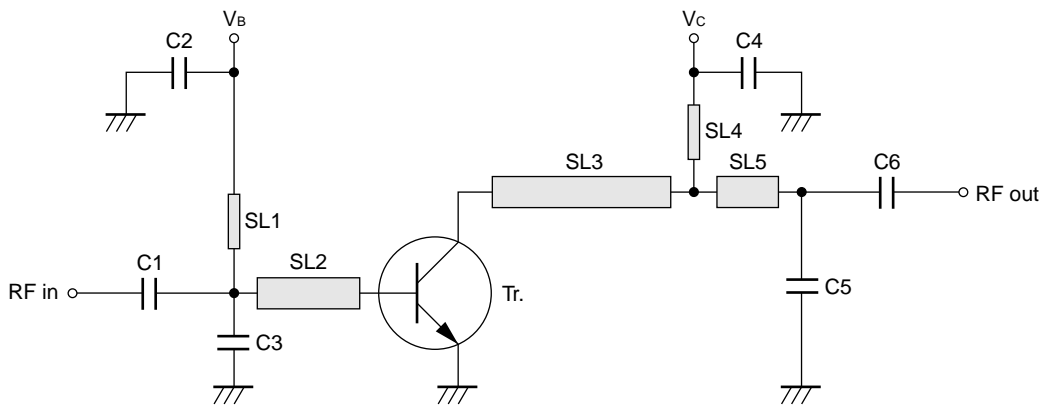

Parts List

Parts	Value	Size	Classification
C1, C6	18 pF		Multilayer ceramic chip capacitor
C2	3 300 pF		Multilayer ceramic chip capacitor
C3	3 pF		Multilayer ceramic chip capacitor
C4	15 pF		Multilayer ceramic chip capacitor
C5	1.5 pF		Multilayer ceramic chip capacitor
SL1, SL4		w = 0.20 mm	Strip line
SL2		w = 0.76 mm, l = 2.5 mm	Strip line
SL3		w = 0.76 mm, l = 5 mm	Strip line
SL5		w = 0.76 mm, l = 1.5 mm	Strip line

EXAMPLE OF CHARACTERISTICS FOR 1.8 GHz PA EVALUATION BOARD

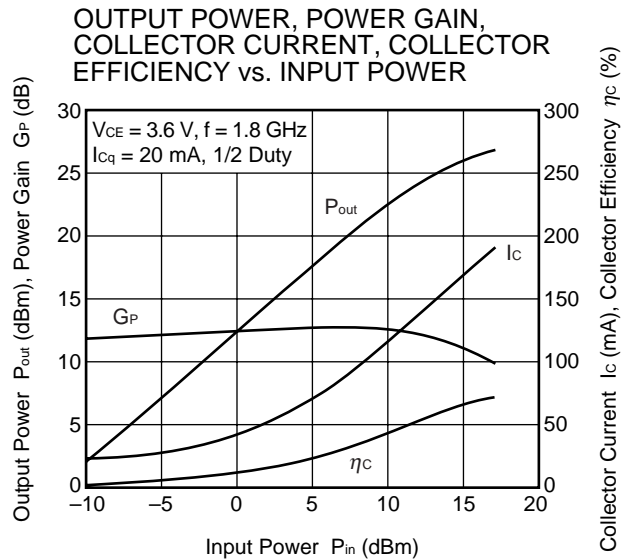
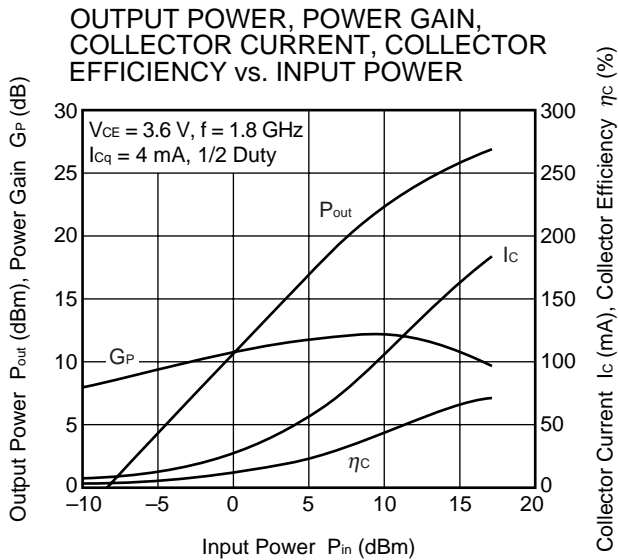
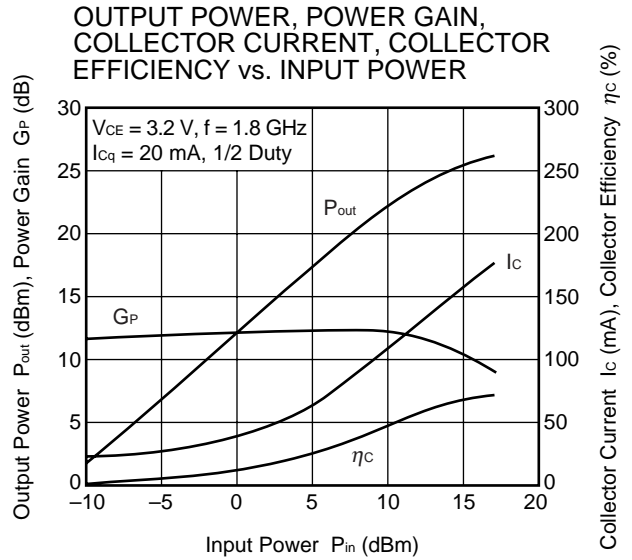
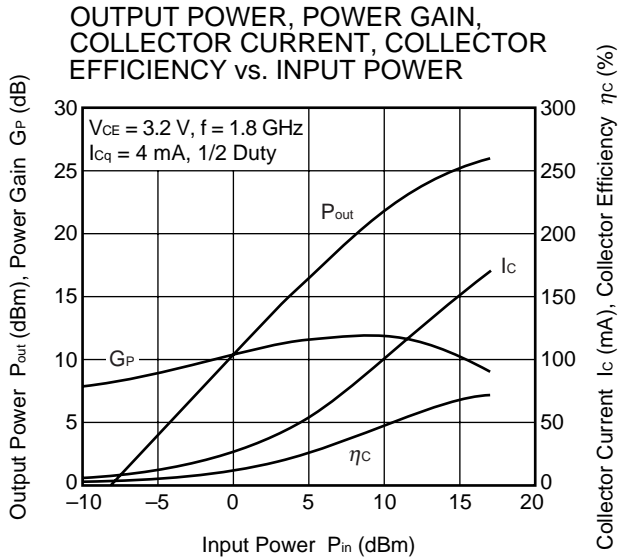

**Remark** The graphs indicate nominal characteristics.

**S-PARAMETERS**

S-parameters/Noise parameters are provided on the NEC Compound Semiconductor Devices Web site in a form (S2P) that enables direct import to a microwave circuit simulator without keyboard input.

Click here to download S-parameters.

[RF and Microwave] → [Device Parameters]

URL <http://www.csd-nec.com/>

PACKAGE DIMENSIONS

FLAT-LEAD 4-PIN THIN-TYPE SUPER MINIMOLD (M04) (UNIT: mm)

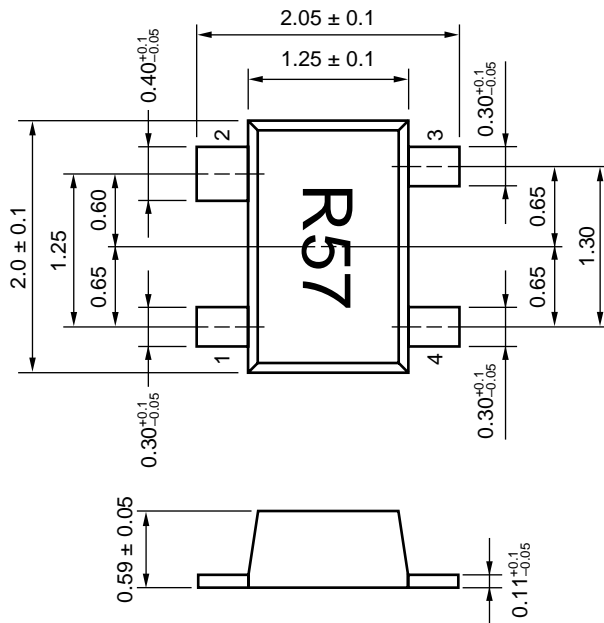
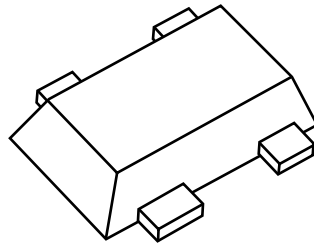

PIN CONNECTIONS

- 1. Emitter
- 2. Collector
- 3. Emitter
- 4. Base

- **The information in this document is current as of March, 2003. The information is subject to change without notice. For actual design-in, refer to the latest publications of NEC's data sheets or data books, etc., for the most up-to-date specifications of NEC semiconductor products. Not all products and/or types are available in every country. Please check with an NEC sales representative for availability and additional information.**
  - No part of this document may be copied or reproduced in any form or by any means without prior written consent of NEC. NEC assumes no responsibility for any errors that may appear in this document.
  - NEC does not assume any liability for infringement of patents, copyrights or other intellectual property rights of third parties by or arising from the use of NEC semiconductor products listed in this document or any other liability arising from the use of such products. No license, express, implied or otherwise, is granted under any patents, copyrights or other intellectual property rights of NEC or others.
  - Descriptions of circuits, software and other related information in this document are provided for illustrative purposes in semiconductor product operation and application examples. The incorporation of these circuits, software and information in the design of customer's equipment shall be done under the full responsibility of customer. NEC assumes no responsibility for any losses incurred by customers or third parties arising from the use of these circuits, software and information.
  - While NEC endeavours to enhance the quality, reliability and safety of NEC semiconductor products, customers agree and acknowledge that the possibility of defects thereof cannot be eliminated entirely. To minimize risks of damage to property or injury (including death) to persons arising from defects in NEC semiconductor products, customers must incorporate sufficient safety measures in their design, such as redundancy, fire-containment, and anti-failure features.
  - NEC semiconductor products are classified into the following three quality grades:  
 "Standard", "Special" and "Specific". The "Specific" quality grade applies only to semiconductor products developed based on a customer-designated "quality assurance program" for a specific application. The recommended applications of a semiconductor product depend on its quality grade, as indicated below. Customers must check the quality grade of each semiconductor product before using it in a particular application.  
 "Standard": Computers, office equipment, communications equipment, test and measurement equipment, audio and visual equipment, home electronic appliances, machine tools, personal electronic equipment and industrial robots  
 "Special": Transportation equipment (automobiles, trains, ships, etc.), traffic control systems, anti-disaster systems, anti-crime systems, safety equipment and medical equipment (not specifically designed for life support)  
 "Specific": Aircraft, aerospace equipment, submersible repeaters, nuclear reactor control systems, life support systems and medical equipment for life support, etc.
- The quality grade of NEC semiconductor products is "Standard" unless otherwise expressly specified in NEC's data sheets or data books, etc. If customers wish to use NEC semiconductor products in applications not intended by NEC, they must contact an NEC sales representative in advance to determine NEC's willingness to support a given application.
- (Note)
- (1) "NEC" as used in this statement means NEC Corporation, NEC Compound Semiconductor Devices, Ltd. and also includes its majority-owned subsidiaries.
  - (2) "NEC semiconductor products" means any semiconductor product developed or manufactured by or for NEC (as defined above).

M8E 00.4-0110

---

► For further information, please contact

**NEC Compound Semiconductor Devices, Ltd.**

5th Sales Group, Sales Division TEL: +81-44-435-1588 FAX: +81-44-435-1579 E-mail: salesinfo@csd-nec.com

**NEC Compound Semiconductor Devices Hong Kong Limited**

Hong Kong Head Office TEL: +852-3107-7303 FAX: +852-3107-7309 E-mail: ncsd-hk@elhk.nec.com.hk

Taipei Branch Office TEL: +886-2-8712-0478 FAX: +886-2-2545-3859

Korea Branch Office TEL: +82-2-558-2120 FAX: +82-2-558-5209

**NEC Electronics (Europe) GmbH** <http://www.ee.nec.de/>

TEL: +49-211-6503-01 FAX: +49-211-6503-487

**California Eastern Laboratories, Inc.** <http://www.cel.com/>

TEL: +1-408-988-3500 FAX: +1-408-988-0279