

SANYO	No.5535A	2SC5374
		NPN Epitaxial Planar Silicon Transistor VHF to UHF Band OSC, High-Frequency Amp Applications

Features

- High gain : $|S_{21e}|^2 = 10.5\text{dB typ (f=1GHz)}$.
- High cutoff frequency : $f_T = 5.2\text{GHz typ}$.

Absolute Maximum Ratings at Ta = 25°C

			unit
Collector-to-Base Voltage	V _{CB0}	20	V
Collector-to-Emitter Voltage	V _{CEO}	10	V
Emitter-to-Base Voltage	V _{EBO}	2	V
Collector Current	I _C	100	mA
Collector Dissipation	P _C	100	mW
Junction Temperature	T _J	150	°C
Storage Temperature	T _{stg}	-55 to +150	°C

Electrical Characteristics at Ta = 25°C

			min	typ	max	unit
Collector Cutoff Current	I _{CB0}	V _{CB} = 10V, I _E = 0			1.0	μA
Emitter Cutoff Current	I _{EBO}	V _{EB} = 1V, I _C = 0			10	μA
DC Current Gain	h _{FE1}	V _{CE} = 3V, I _C = 7mA	110		180	
	h _{FE2}	V _{CE} = 3V, I _C = 30mA	100			
Gain-Bandwidth Product	f _T	V _{CE} = 3V, I _C = 7mA	3	5.2		GHz
Output Capacitance	C _{ob}	V _{CB} = 3V, f = 1MHz		1.0	1.5	pF
Reverse Transfer Capacitance	C _{re}	V _{CB} = 3V, f = 1MHz		0.7		pF
Forward Transfer Gain	$ S_{21e} ^2$	V _{CE} = 3V, I _C = 7mA, f = 1GHz	8	10.5		dB
Noise Figure	N _F	V _{CE} = 3V, I _C = 7mA, f = 1GHz		1.4	2.5	dB

Marking : NA

Package Dimensions 2106A
(unit : mm)

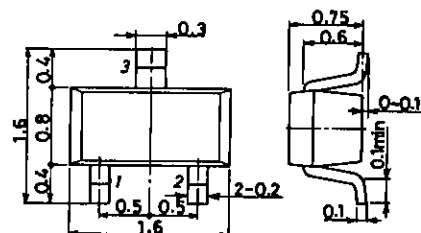

- 1: Base
- 2: Emitter
- 3: Collector

SANYO: SMCP

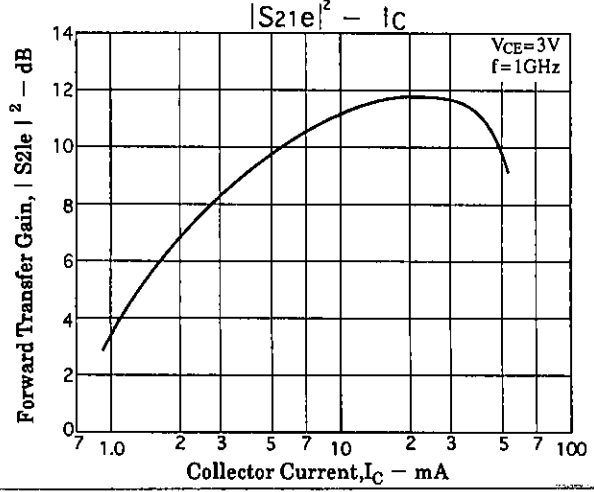
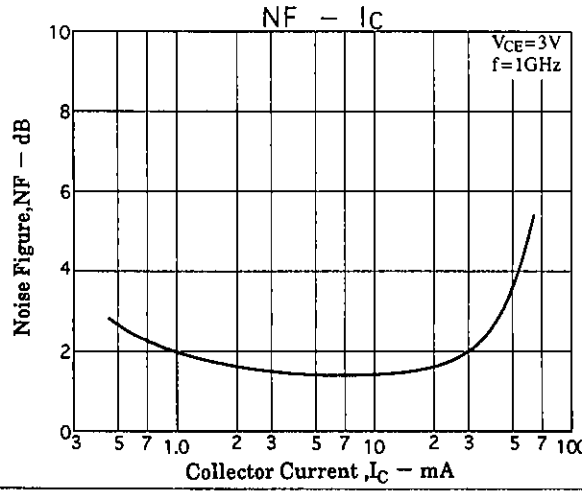
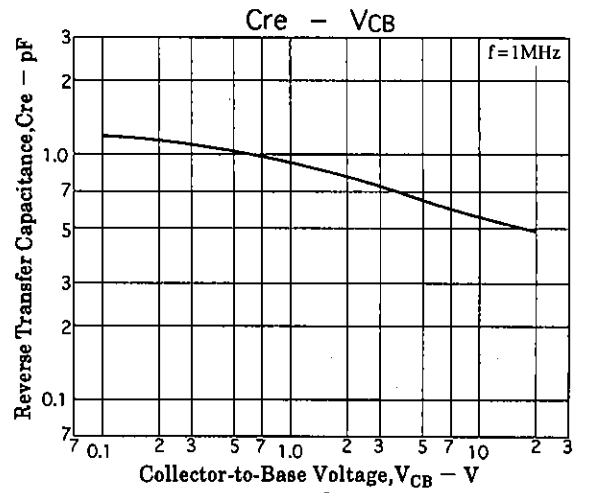
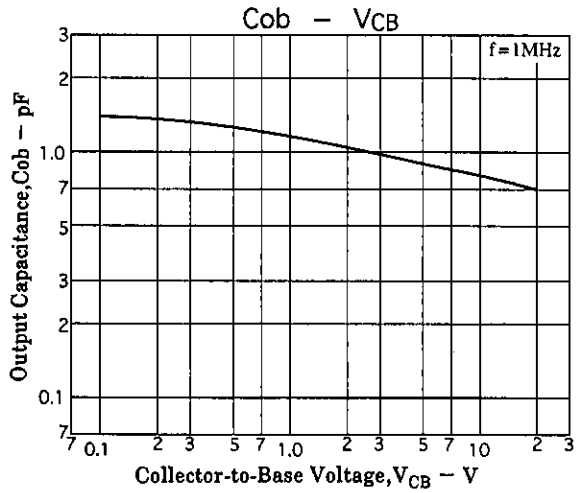
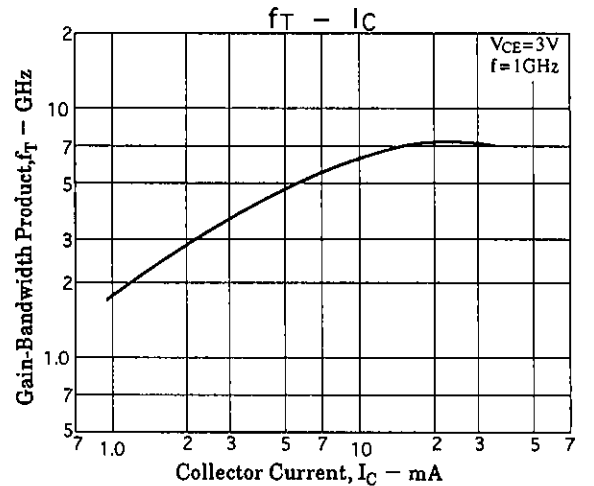
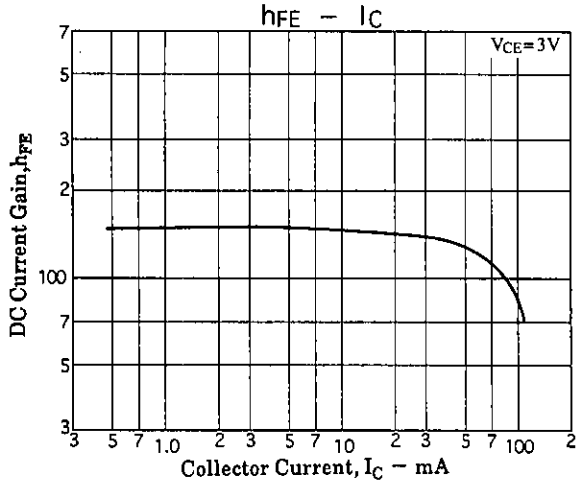
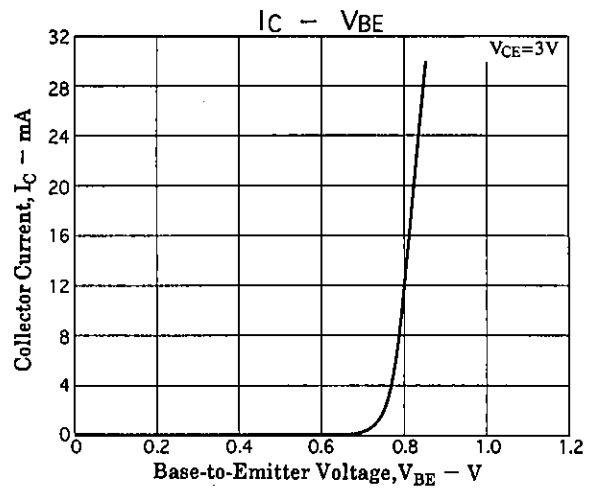
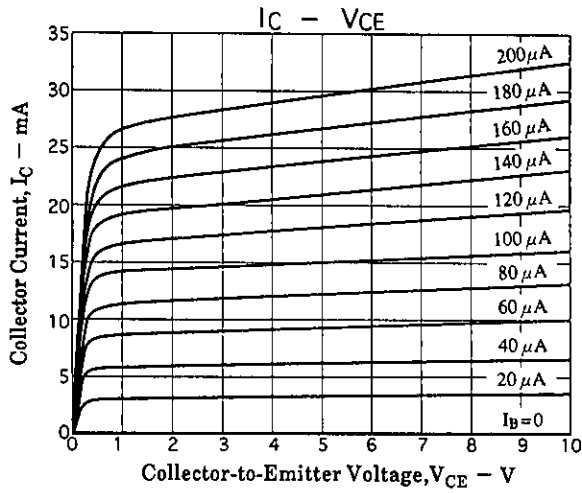

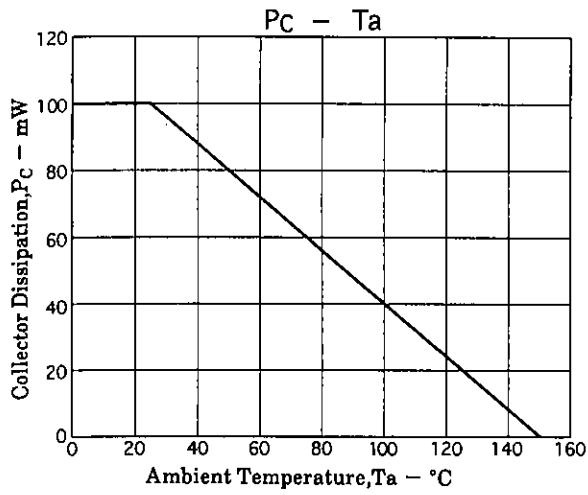

S Parameters

S11e

$f = 100\text{MHz}$, 200 to 2000MHz (200MHz step)

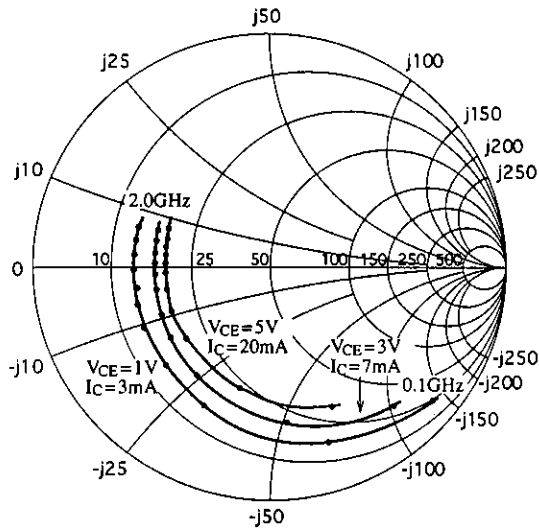

S21e

$f = 100\text{MHz}$, 200 to 2000MHz (200MHz step)

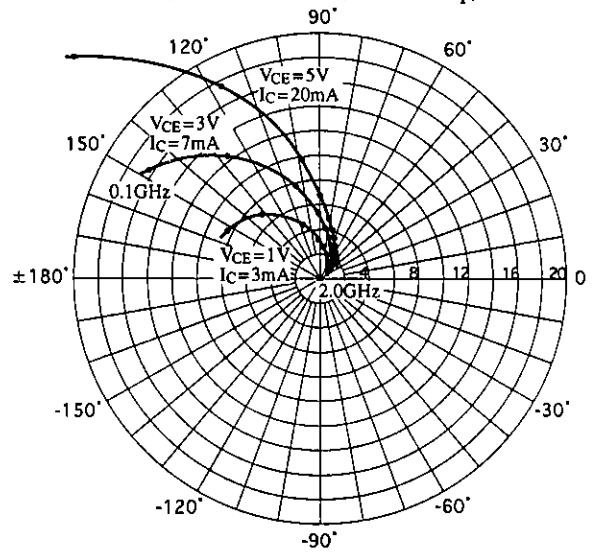

S12e

$f = 100\text{MHz}$, 200 to 2000MHz (200MHz step)

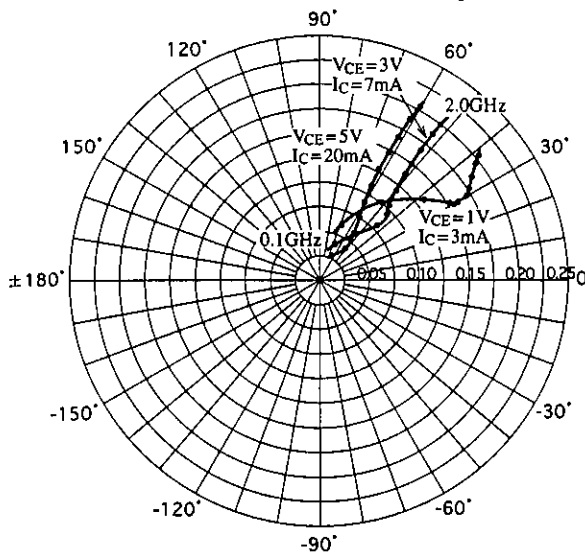

S22e

$f = 100\text{MHz}$, 200 to 2000MHz (200MHz step)

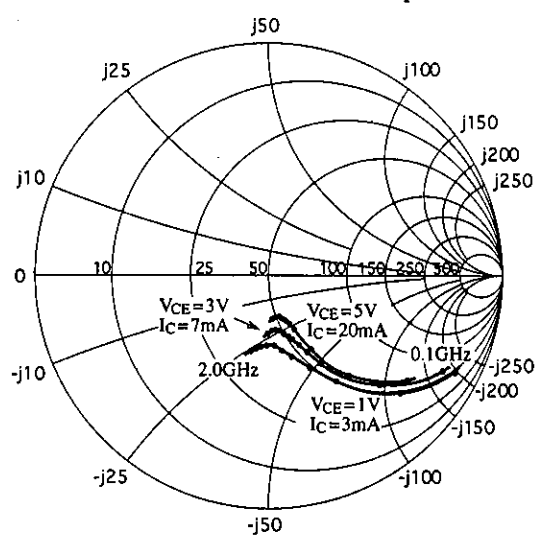

S Parameters (Common emitter) $V_{CE}=1V, I_C=3mA, Z_O=50\Omega$

Freq (MHz)	$ S_{11} $	$\angle S_{11}$	$ S_{21} $	$\angle S_{21}$	$ S_{12} $	$\angle S_{12}$	$ S_{22} $	$\angle S_{22}$
100	0.874	-40.6	8.627	152.3	0.062	67.9	0.918	-23.4
200	0.785	-71.6	6.874	132.5	0.101	52.1	0.748	-41.7
400	0.651	-114.8	4.701	107.3	0.135	37.1	0.537	-57.6
600	0.613	-136.9	3.365	92.8	0.152	31.1	0.430	-65.6
800	0.581	-153.9	2.716	81.9	0.155	29.9	0.361	-74.3
1000	0.568	-164.2	2.218	73.4	0.161	30.0	0.326	-80.2
1200	0.556	-172.0	1.863	66.2	0.170	30.5	0.300	-86.1
1400	0.563	-178.1	1.626	59.6	0.177	32.7	0.297	-92.3
1600	0.558	175.4	1.473	53.9	0.185	35.4	0.306	-96.5
1800	0.560	168.9	1.345	48.1	0.196	37.4	0.313	-100.6
2000	0.567	163.1	1.230	42.5	0.205	38.0	0.335	-102.9

 $V_{CE}=3V, I_C=7mA, Z_O=50\Omega$

Freq (MHz)	$ S_{11} $	$\angle S_{11}$	$ S_{21} $	$\angle S_{21}$	$ S_{12} $	$\angle S_{12}$	$ S_{22} $	$\angle S_{22}$
100	0.789	-48.3	16.232	147.7	0.039	66.1	0.862	-27.2
200	0.670	-83.7	12.431	126.4	0.061	53.0	0.673	-44.6
400	0.552	-123.8	7.607	104.7	0.081	45.2	0.438	-59.1
600	0.522	-145.3	5.401	92.7	0.094	45.9	0.333	-65.1
800	0.504	-158.5	4.155	84.1	0.106	48.2	0.290	-68.7
1000	0.488	-169.1	3.425	77.1	0.121	49.1	0.270	-71.0
1200	0.478	-176.1	2.849	71.0	0.136	51.0	0.253	-74.7
1400	0.481	178.4	2.511	65.6	0.152	52.2	0.239	-79.6
1600	0.478	172.7	2.237	60.7	0.167	52.8	0.240	-82.8
1800	0.492	167.4	2.016	55.5	0.185	53.2	0.245	-86.7
2000	0.489	162.0	1.844	50.5	0.200	52.7	0.248	-90.0

 $V_{CE}=5V, I_C=20mA, Z_O=50\Omega$

Freq (MHz)	$ S_{11} $	$\angle S_{11}$	$ S_{21} $	$\angle S_{21}$	$ S_{12} $	$\angle S_{12}$	$ S_{22} $	$\angle S_{22}$
100	0.643	-66.4	26.381	137.4	0.029	62.8	0.748	-36.3
200	0.530	-104.6	17.543	116.5	0.041	54.2	0.531	-52.5
400	0.459	-140.3	9.835	98.9	0.058	55.4	0.322	-62.7
600	0.447	-157.2	6.805	89.4	0.074	59.2	0.246	-65.5
800	0.440	-168.4	5.210	82.4	0.092	61.4	0.213	-68.6
1000	0.434	-175.9	4.194	76.6	0.110	61.9	0.199	-70.2
1200	0.437	177.1	3.518	71.5	0.129	62.3	0.191	-72.9
1400	0.437	173.0	3.077	66.7	0.148	61.8	0.184	-76.5
1600	0.438	168.4	2.730	62.5	0.166	61.6	0.181	-80.9
1800	0.439	164.2	2.469	58.0	0.186	60.7	0.186	-84.8
2000	0.444	159.1	2.249	53.5	0.203	59.5	0.192	-87.3

- No products described or contained herein are intended for use in surgical implants, life-support systems, aerospace equipment, nuclear power control systems, vehicles, disaster/crime-prevention equipment and the like, the failure of which may directly or indirectly cause injury, death or property loss.
- Anyone purchasing any products described or contained herein for an above-mentioned use shall:
 - ① Accept full responsibility and indemnify and defend SANYO ELECTRIC CO., LTD., its affiliates, subsidiaries and distributors and all their officers and employees, jointly and severally, against any and all claims and litigation and all damages, cost and expenses associated with such use:
 - ② Not impose any responsibility for any fault or negligence which may be cited in any such claim or litigation on SANYO ELECTRIC CO., LTD., its affiliates, subsidiaries and distributors or any of their officers and employees jointly or severally.
- Information (including circuit diagrams and circuit parameters) herein is for example only; it is not guaranteed for volume production. SANYO believes information herein is accurate and reliable, but no guarantees are made or implied regarding its use or any infringements of intellectual property rights or other rights of third parties.

This catalog provides information as of September, 1996. Specifications and information herein are subject to change without notice.