

<b>SANYO</b>	No.3020	<b>2SC4399</b>
		NPN Epitaxial Planar Silicon Transistor High-Frequency General-Purpose Amp Applications

**Features**

- High power gain : PG=25dB typ (f=100MHz)
- Very small-sized package permitting the 2SC4399-applied sets to be made small and slim

**Absolute Maximum Ratings at Ta=25°C**

			unit
Collector to Base Voltage	V <sub>CB0</sub>	30	V
Collector to Emitter Voltage	V <sub>CE0</sub>	20	V
Emitter to Base Voltage	V <sub>EB0</sub>	5	V
Collector Current	I <sub>C</sub>	30	mA
Collector Dissipation	P <sub>C</sub>	150	mW
Junction Temperature	T <sub>j</sub>	150	°C
Storage Temperature	T <sub>stg</sub>	-55 to +150	°C

**Electrical Characteristics at Ta=25°C**

			min	typ	max	unit
Collector Cutoff Current	I <sub>CB0</sub>	V <sub>CB</sub> =10V, I <sub>E</sub> =0			0.1	μA
Emitter Cutoff Current	I <sub>EB0</sub>	V <sub>EB</sub> =4V, I <sub>C</sub> =0			0.1	μA
DC Current Gain	h <sub>FE</sub>	V <sub>CE</sub> =6V, I <sub>C</sub> =1mA	60*		270*	
Gain-Bandwidth Product	f <sub>T</sub>	V <sub>CE</sub> =6V, I <sub>C</sub> =1mA	200	320		MHz
Reverse Transfer Capacitance	c <sub>re</sub>	V <sub>CB</sub> =6V, f=1MHz		0.9	1.2	pF
Base to Collector Time Constant	r <sub>bb</sub> 'C <sub>c</sub>	V <sub>CE</sub> =6V, I <sub>C</sub> =1mA, f=31.9MHz		12	20	ps
Power Gain	PG	V <sub>CE</sub> =6V, I <sub>C</sub> =1mA, f=100MHz		25		dB
Noise Figure	NF	V <sub>CE</sub> =6V, I <sub>C</sub> =1mA, f=100MHz		3.0		dB

\* : The 2SC4399 is classified by 1mA h<sub>FE</sub> as follows:

60	3	120	90	4	180	135	5	270
----	---	-----	----	---	-----	-----	---	-----

Marking : F

h<sub>FE</sub> rank : 3,4,5

**NF,PG Test Circuit**

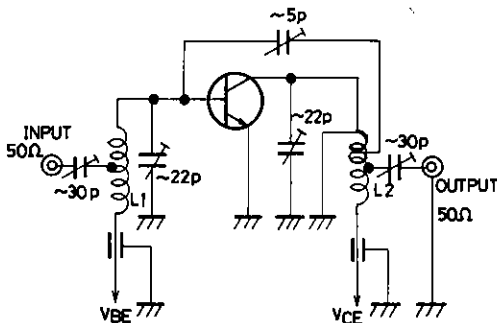

- L1 : 1mmϕ plated wire 10mmϕ 4T, tap : 2T from V<sub>BE</sub> side
- L2 : 1mmϕ plated wire 10mmϕ 7T, tap : 1T from V<sub>CE</sub> side
- L3 : 1mmϕ enameled wire 10mmϕ 3T

Unit (Capacitance : F)

**Package Dimensions 2059A**

(unit : mm)

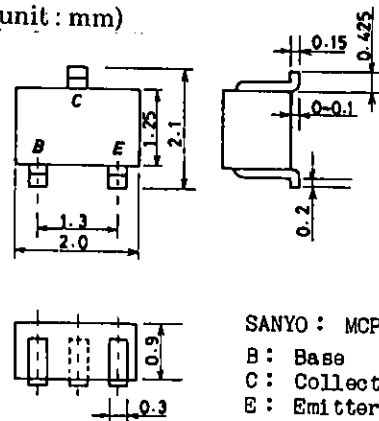

SANYO : MCP

B : Base

C : Collector

E : Emitter

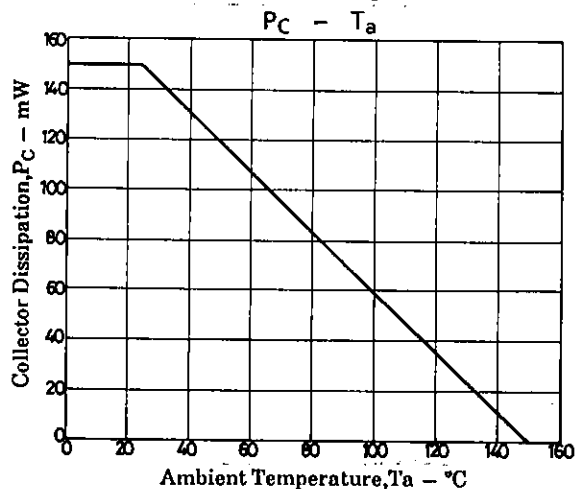
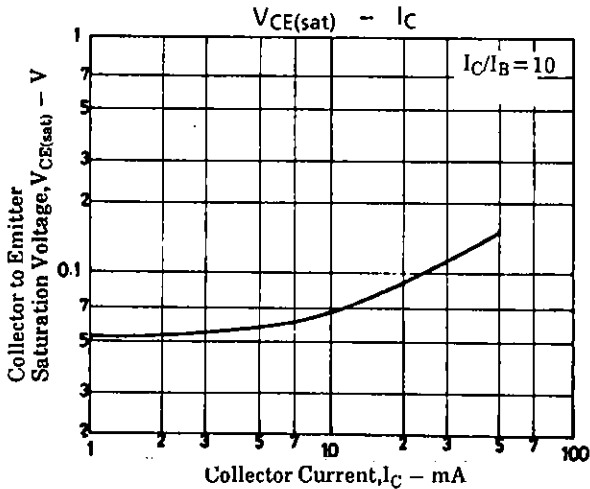
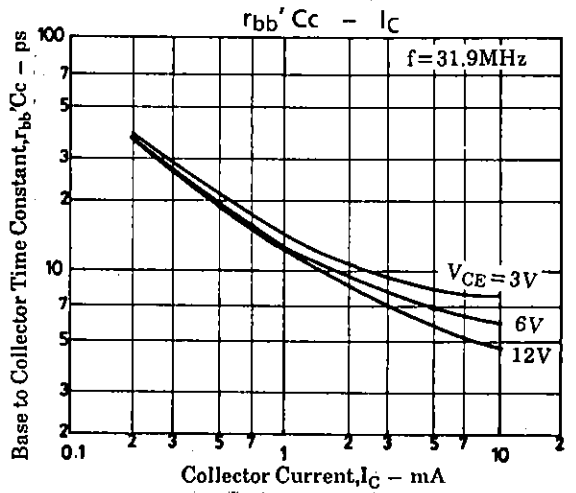
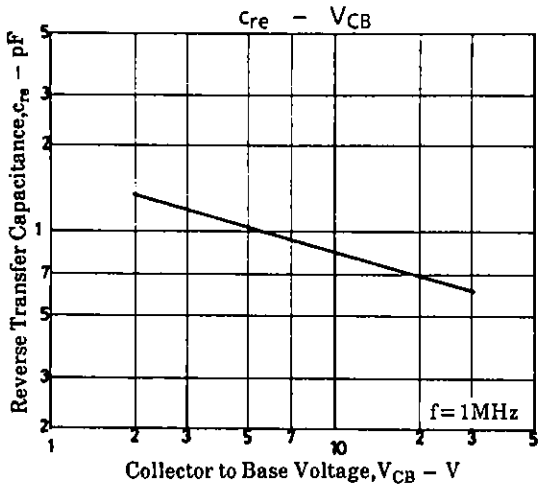
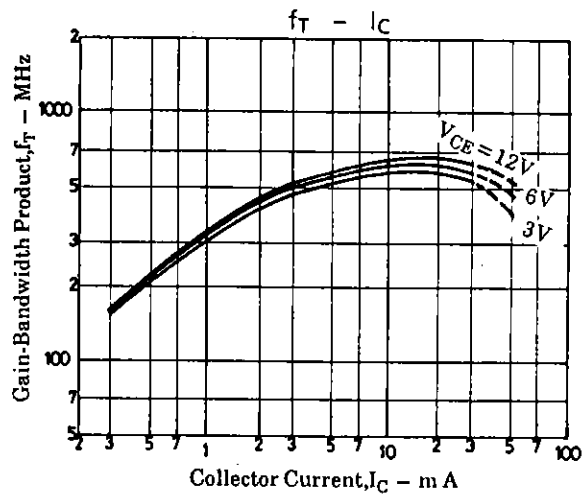
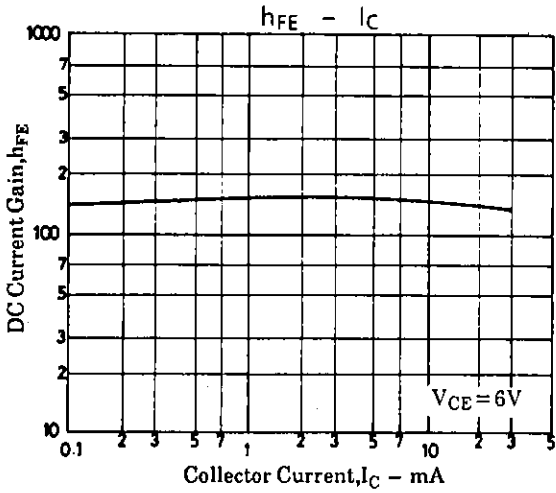
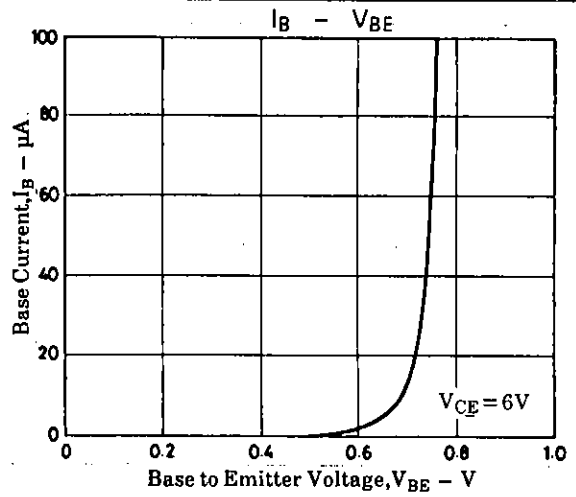
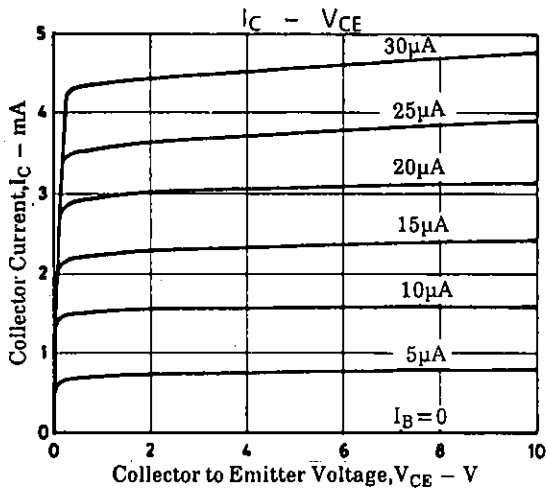

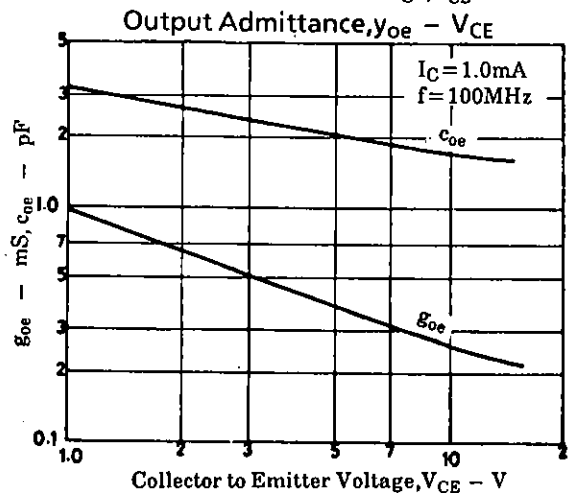
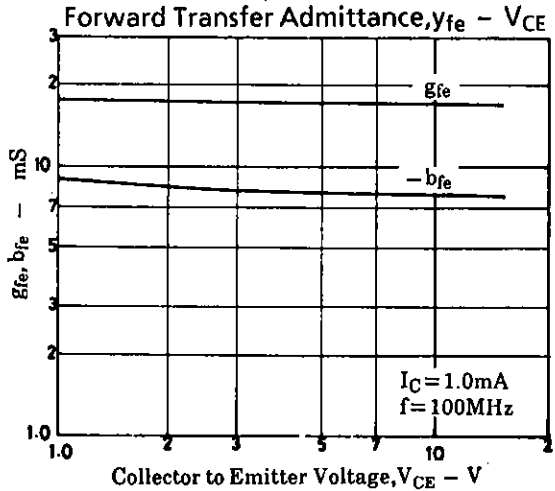
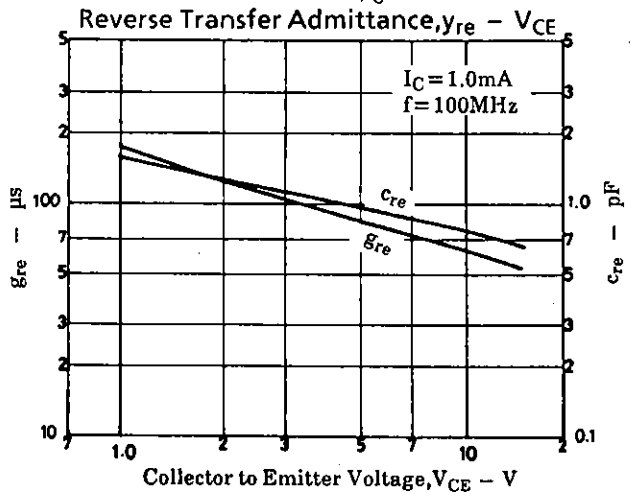
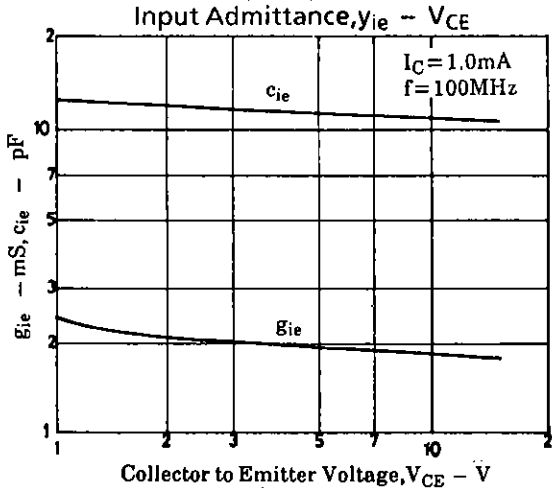
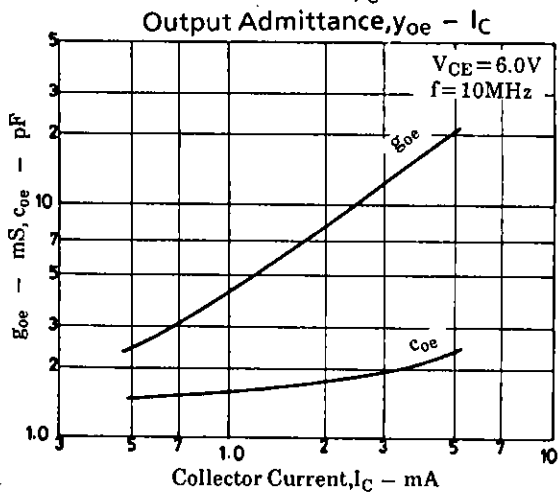
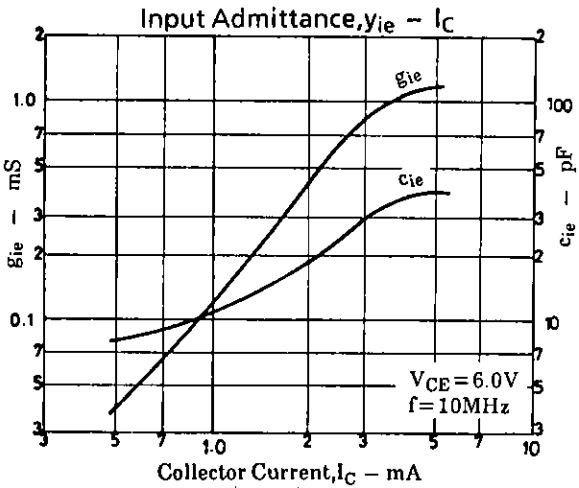
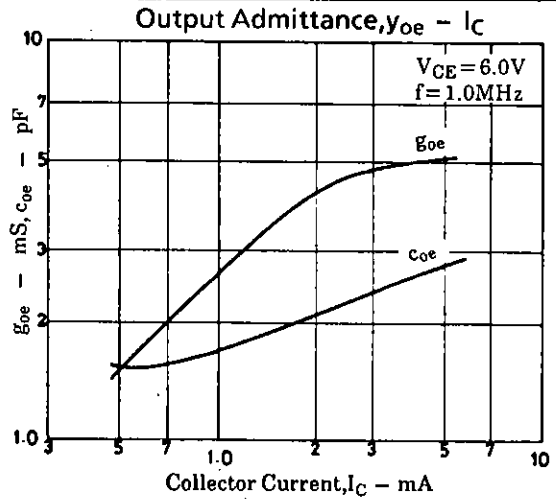
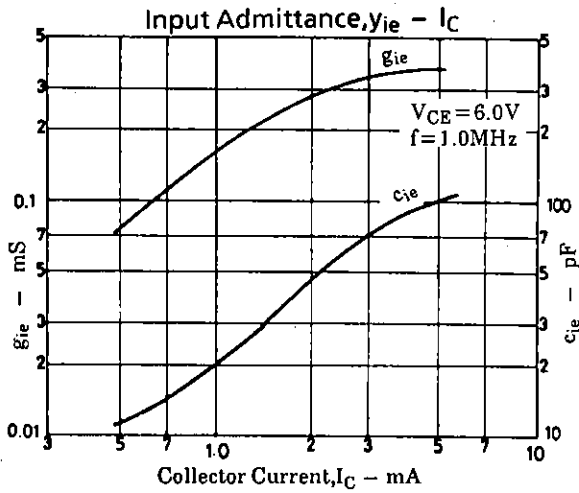

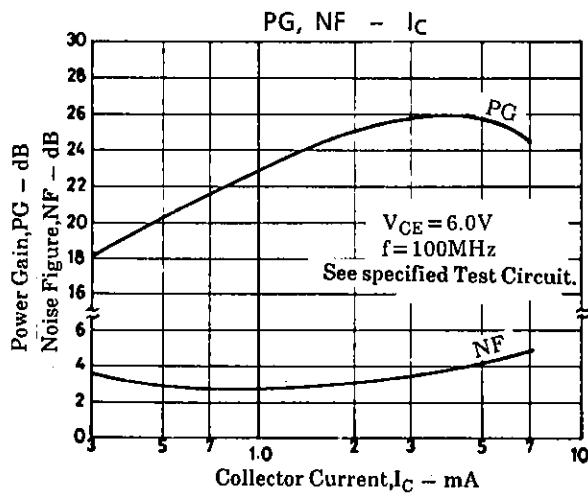
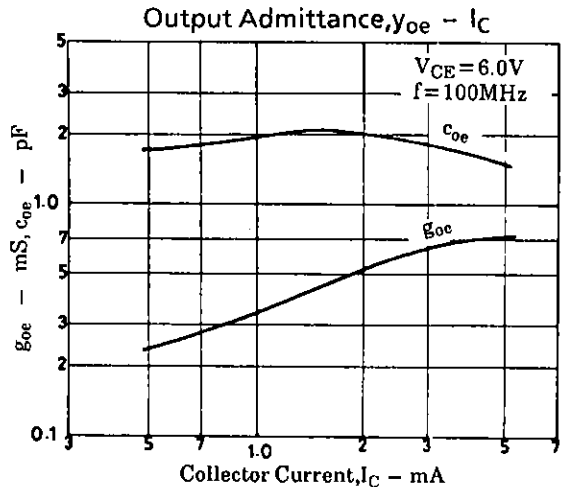
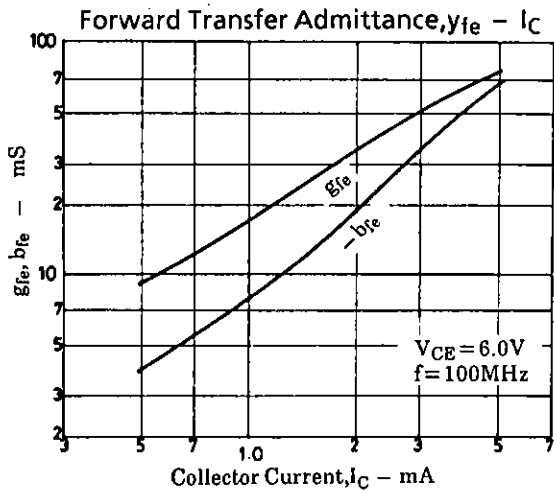
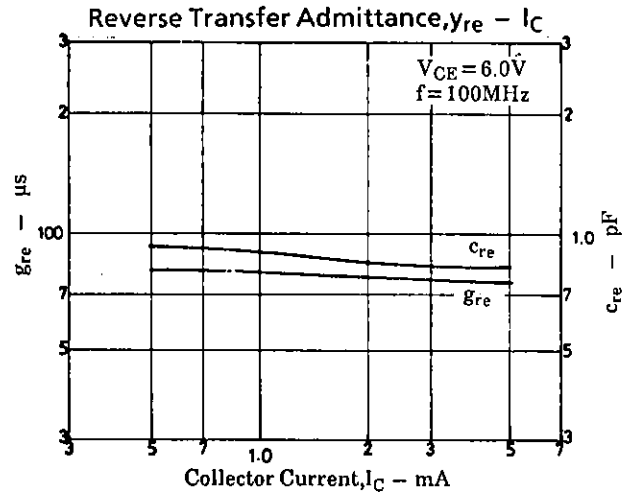
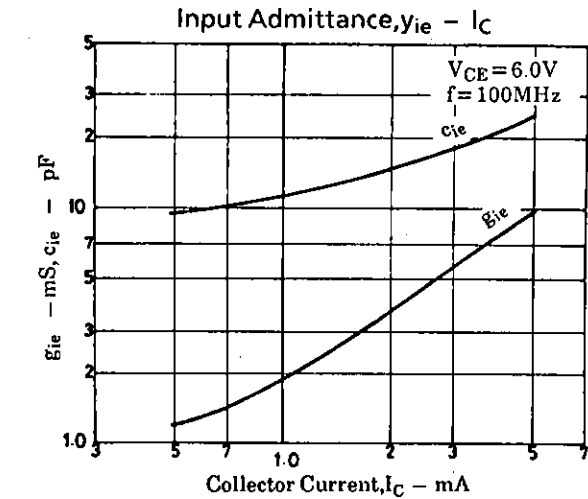

■ No products described or contained herein are intended for use in surgical implants, life-support systems, aerospace equipment, nuclear power control systems, vehicles, disaster/crime-prevention equipment and the like, the failure of which may directly or indirectly cause injury, death or property loss.

■ Anyone purchasing any products described or contained herein for an above-mentioned use shall:

- ① Accept full responsibility and indemnify and defend SANYO ELECTRIC CO., LTD., its affiliates, subsidiaries and distributors and all their officers and employees, jointly and severally, against any and all claims and litigation and all damages, cost and expenses associated with such use;
- ② Not impose any responsibility for any fault or negligence which may be cited in any such claim or litigation on SANYO ELECTRIC CO., LTD., its affiliates, subsidiaries and distributors or any of their officers and employees jointly or severally.

■ Information (including circuit diagrams and circuit parameters) herein is for example only; it is not guaranteed for volume production. SANYO believes information herein is accurate and reliable, but no guarantees are made or implied regarding its use or any infringements of intellectual property rights or other rights of third parties.