

HIGH FREQUENCY AMPLIFIER AND SWITCHING
NPN SILICON EPITAXIAL TRANSISTOR
MINI MOLD

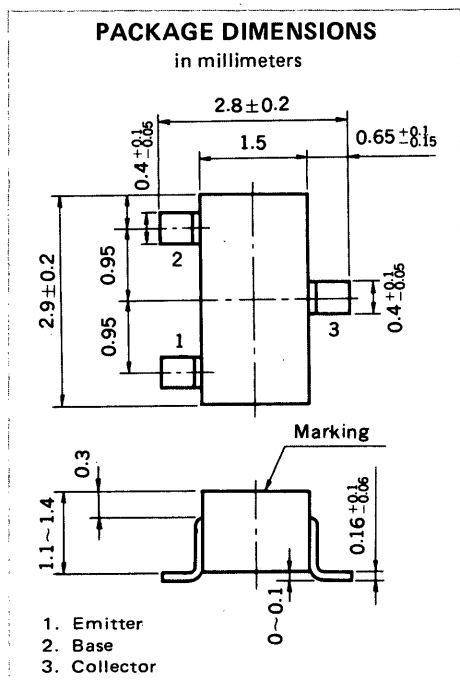

FEATURES

- High Gain Bandwidth Product: $f_T = 200$ MHz MIN.
- Complementary to 2SA1464

ABSOLUTE MAXIMUM RATINGS

Maximum Voltages and Current ($T_a = 25^\circ\text{C}$)

Collector to Base Voltage	V_{CB0}	60	V
Collector to Emitter Voltage	V_{CEO}	40	V
Emitter to Base Voltage	V_{EBO}	5.0	V
Collector Current (DC)	I_C	500	mA

Maximum Power Dissipation

Total Power Dissipation at 25°C Ambient Temperature	P_T	200	mW
--	-------	-----	----

Maximum Temperatures

Junction Temperature	T_j	150	$^\circ\text{C}$
Storage Temperature Range	T_{stg}	-55 to +150	$^\circ\text{C}$

ELECTRICAL CHARACTERISTICS ($T_a = 25^\circ\text{C}$)

CHARACTERISTIC	SYMBOL	MIN.	TYP.	MAX.	UNIT	TEST CONDITIONS
Collector Cutoff Current	I_{CBO}			100	nA	$V_{CB} = 40\text{ V}, I_E = 0$
Emitter Cutoff Current	I_{EBO}			100	nA	$V_{EB} = 4.0\text{ V}, I_C = 0$
DC Current Gain	h_{FE1}	75	150	300		$V_{CE} = 1.0\text{ V}, I_C = 150\text{ mA}$
DC Current Gain	h_{FE2}	20	75			$V_{CE} = 2.0\text{ V}, I_C = 500\text{ mA}$
Collector Saturation Voltage	$V_{CE(sat)}$		0.25	0.75	V	$I_C = 500\text{ mA}, I_B = 50\text{ mA}$
Base Saturation Voltage	$V_{BE(sat)}$		1.0	1.2	V	$I_C = 500\text{ mA}, I_B = 50\text{ mA}$
Gain Bandwidth Product	f_T	200	400		MHz	$V_{CE} = 10\text{ V}, I_E = -20\text{ mA}$
Output Capacitance	C_{ob}		3.5	8.0	pF	$V_{CB} = 10\text{ V}, I_E = 0, f = 1.0\text{ MHz}$
Turn-on Time	t_{on}			35	ns	$V_{CC} = 30\text{ V}$
Storage Time	t_{stg}			225	ns	$I_C = 150\text{ mA}$
Turn-off Time	t_{off}			275	ns	$I_{B1} = -I_{B2} = 15\text{ mA}$

* Pulsed: $PW \leq 350\ \mu\text{s}$, Duty Cycle $\leq 2\%$

h_{FE} Classification

Marking	B12	B13	B14
h_{FE1}	75 to 150	100 to 200	150 to 300

SWITCHING TIME TEST CIRCUIT

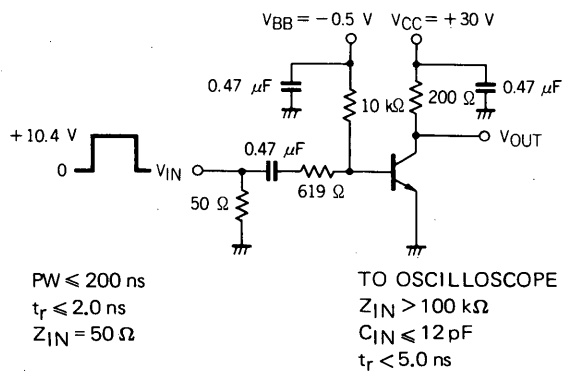

$PW \leq 200 \text{ ns}$
 $t_r \leq 2.0 \text{ ns}$
 $Z_{IN} = 50 \Omega$

t_{on} SWITCHING

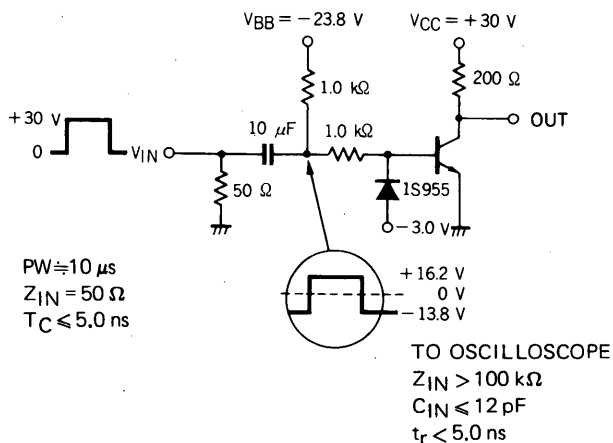

$PW \approx 10 \mu\text{s}$
 $Z_{IN} = 50 \Omega$
 $T_C \leq 5.0 \text{ ns}$

t_{off} SWITCHING

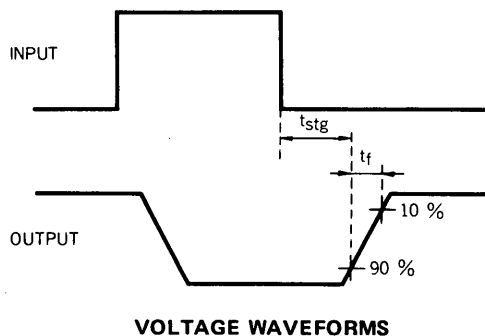
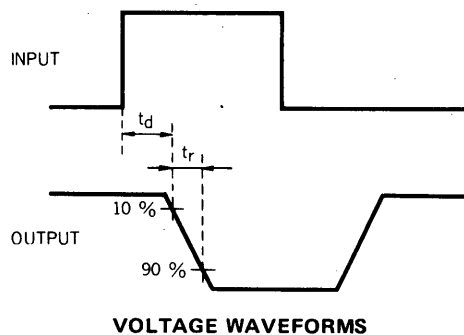

TYPICAL CHARACTERISTICS ($T_a = 25^\circ\text{C}$)

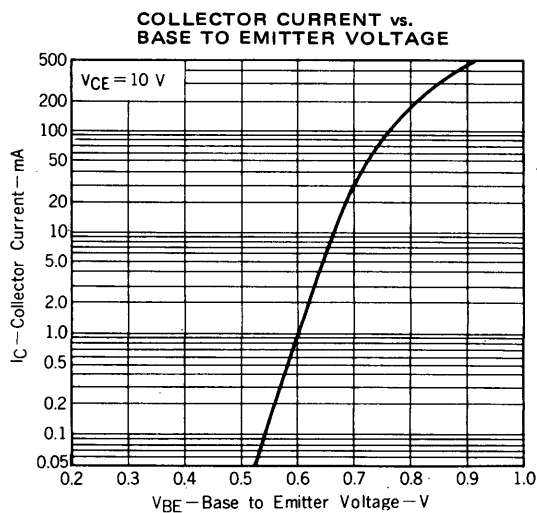
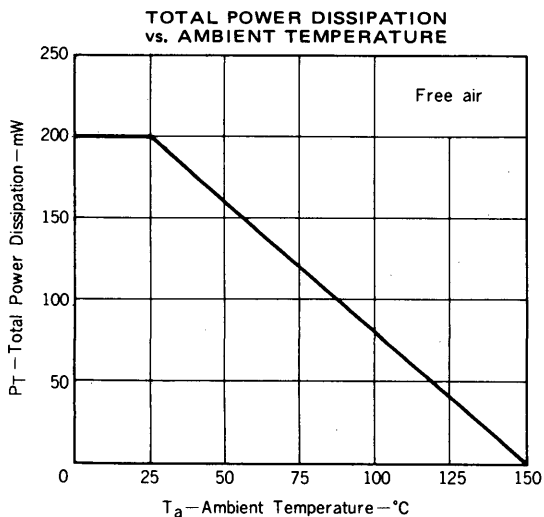

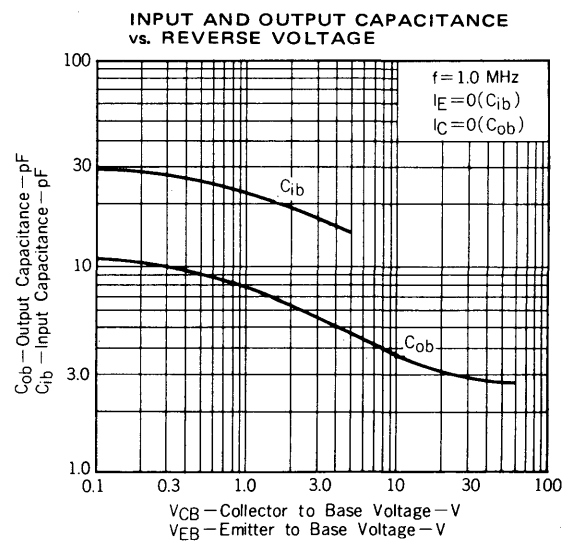
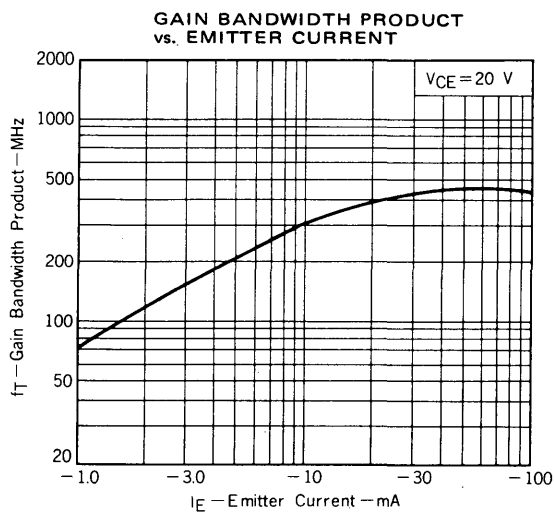
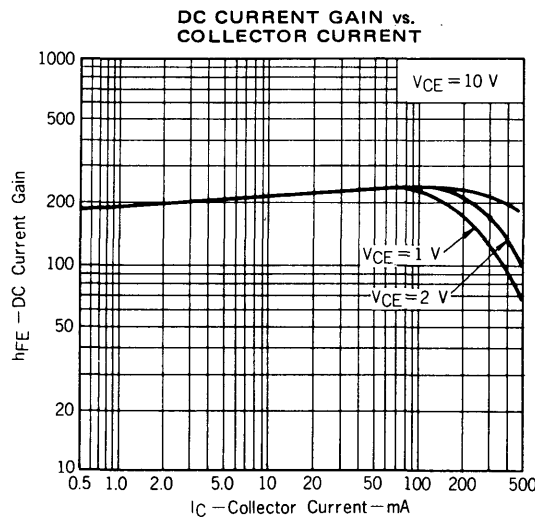
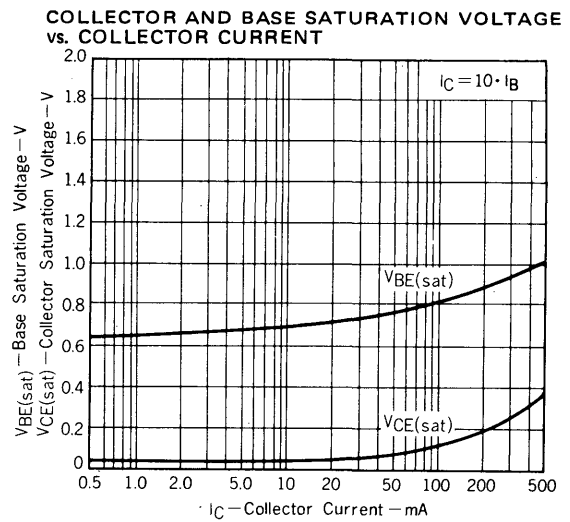
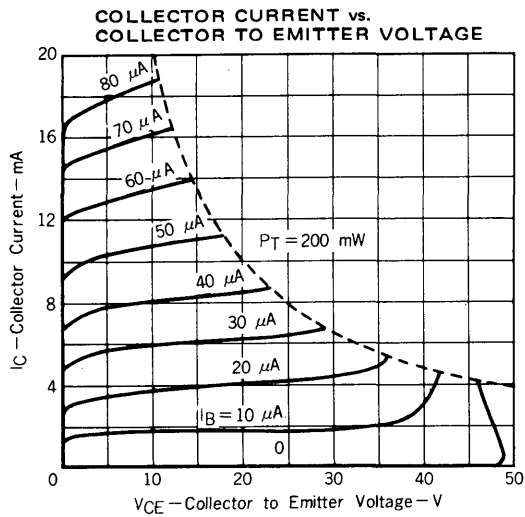

DELAY TIME vs. COLLECTOR CURRENT

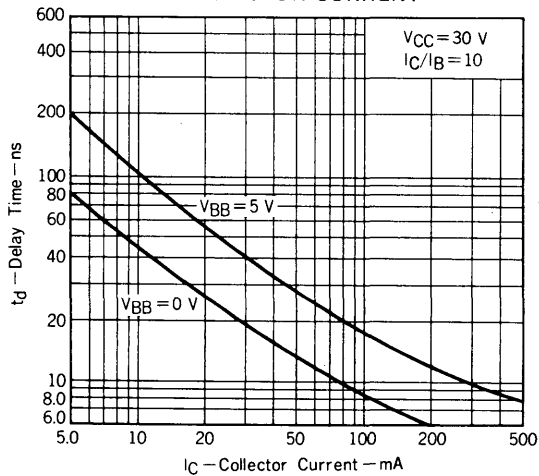

RISE TIME vs. COLLECTOR CURRENT

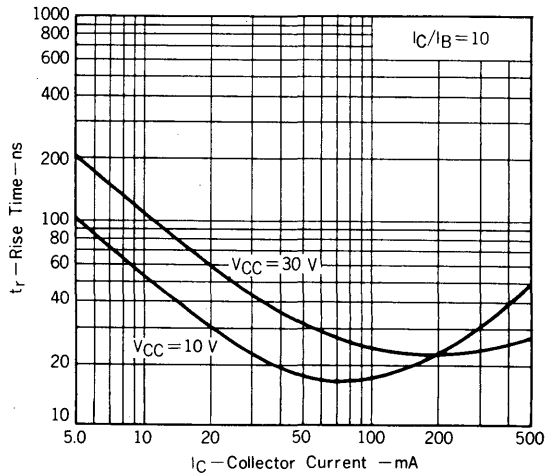

STORAGE TIME vs. COLLECTOR CURRENT

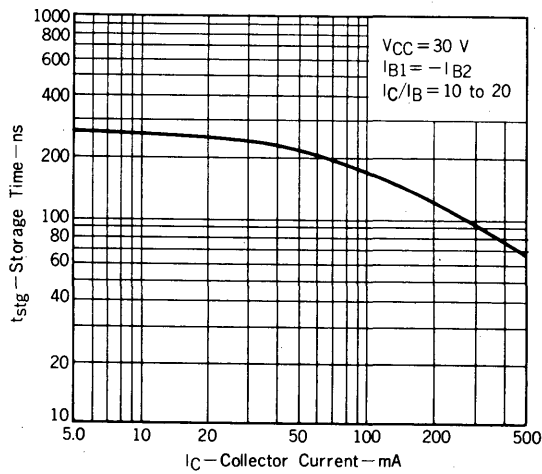

FALL TIME vs. COLLECTOR CURRENT

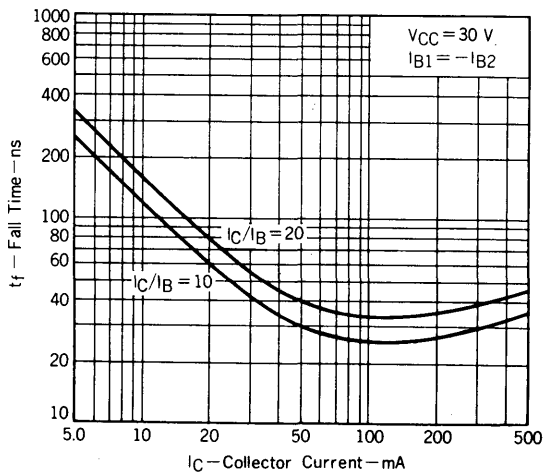



[MEMO]

No part of this document may be copied or reproduced in any form or by any means without the prior written consent of NEC Corporation. NEC Corporation assumes no responsibility for any errors which may appear in this document.

NEC Corporation does not assume any liability for infringement of patents, copyrights or other intellectual property rights of third parties by or arising from use of a device described herein or any other liability arising from use of such device. No license, either express, implied or otherwise, is granted under any patents, copyrights or other intellectual property rights of NEC Corporation or of others.