

# 2SA1344, 2SC3398



2018A

PNP/NPN Epitaxial Planar  
Silicon Transistors

T-37-13  
T-35-11

## Switching Applications (with Bias Resistances $R_1=10k\Omega$ , $R_2=10k\Omega$ )

©1286C

### Applications

- Switching circuit, inverter circuit, interface circuit, driver circuit.

### Features

- Built-in bias resistor ( $R_1=10k\Omega$ ,  $R_2=10k\Omega$ ).
- Small-sized package (CP).

( ): 2SA1344

### Absolute Maximum Ratings/ $T_a=25^\circ C$

			unit
Collector to Base Voltage	$V_{CBO}$	(-)50	V
Collector to Emitter Voltage	$V_{CEO}$	(-)50	V
Emitter to Base Voltage	$V_{EBO}$	(-)10	V
Collector Current	$I_C$	(-)100	mA
Peak Collector Current	$i_{cp}$	(-)200	mA
Collector Dissipation	$P_C$	200	mW
Junction Temperature	$T_j$	150	$^\circ C$
Storage Temperature	$T_{stg}$	-55 to +150	$^\circ C$

### Electrical Characteristics/ $T_a=25^\circ C$

			min	typ	max	unit
Collector Cutoff Current	$I_{CBO}$	$V_{CB}=(-)40V, I_E=0$			(-)0.1	$\mu A$
Collector Cutoff Current	$I_{CEO}$	$V_{CE}=(-)40V, I_B=0$			(-)0.5	$\mu A$
Emitter Cutoff Current	$I_{EBO}$	$V_{EB}=(-)5V, I_C=0$	(-)170	(-)250	(-)330	$\mu A$
DC Current Gain	$h_{FE}$	$V_{CE}=(-)5V, I_C=(-)10mA$	50			
Gain Band-width product	$f_T$	$V_{CE}=(-)10V, I_C=(-)5mA$		250		MHz
				(200)		
Output Capacitance	$c_{ob}$	$V_{CB}=(-)10V, f=1MHz$		3.5		pF
				(5.3)		
Collector to Emitter Saturation Voltage	$V_{CE(sat)}$	$I_C=(-)10mA, I_B=(-)0.5mA$	(-)0.1	(-)0.3		V

Continued on next page.

### Marking

2SA1344: EL, 2SC3398: EY

### Electrical Connection

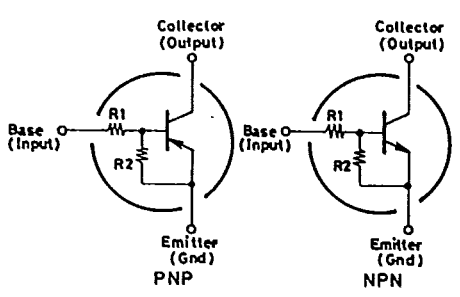

### Case Outline 2018A (unit: mm)

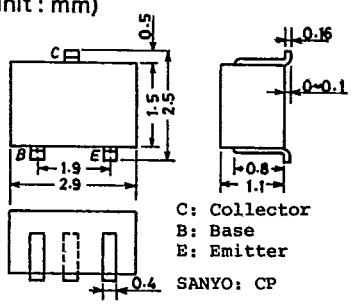

2SA1344/2SC3398

T-37-13

T-35-11

Continued from preceding page.

			min	typ	max	unit
Collector to Base Breakdown Voltage	$V_{(BR)CBO}$	$I_C=(-)10\mu A, I_E=0$	(-)50			V
Collector to Emitter Breakdown Voltage	$V_{(BR)CEO}$	$I_C=(-)100\mu A, R_{BE}=\infty$	(-)50			V
Input Off Voltage	$V_{I(off)}$	$V_{CE}=(-)5V, I_C=(-)100\mu A$	(-)0.8	(-)1.1	(-)1.5	V
Input On Voltage	$V_{I(on)}$	$V_{CE}=(-)0.2V, I_C=(-)10mA$	(-)1.0	(-)2.0	(-)4.0	V
Input Resistance	$R_1$		7.0	10	13	k $\Omega$
Input Resistance Ratio	$R_1/R_2$		0.9	1.0	1.1	-

■ Sample Application Circuit

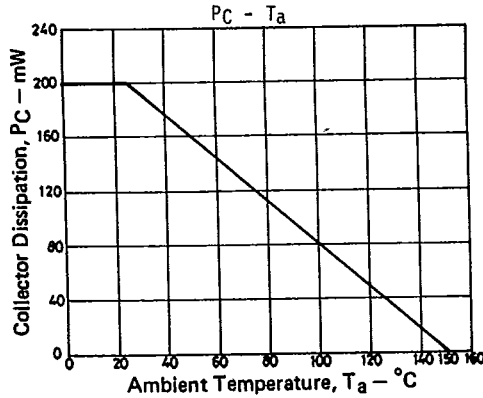
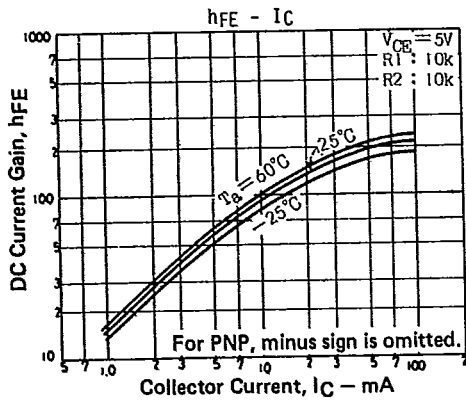
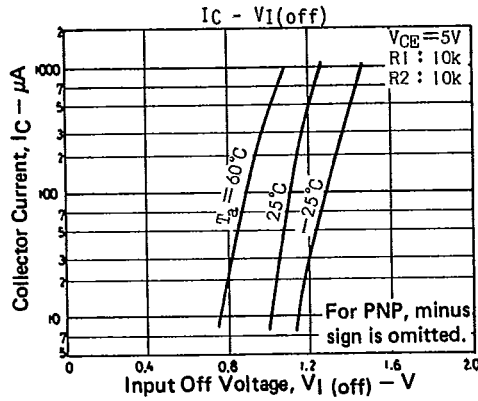
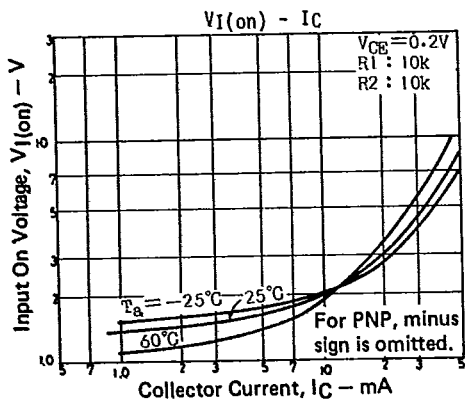
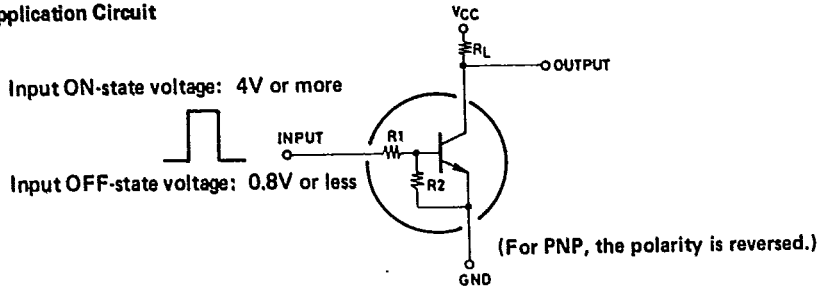

T-91-20

# CASE OUTLINES OF SURFACE MOUNT TRANSISTORS

- All of Sanyo surface mount transistor case outlines are illustrated below.
- All dimensions are in mm, and dimensions which are not followed by min. or max. are represented by typical values.
- No marking is indicated.

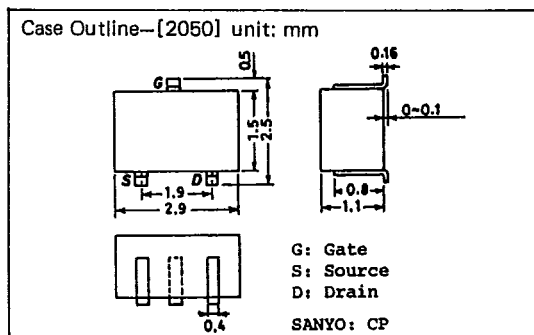
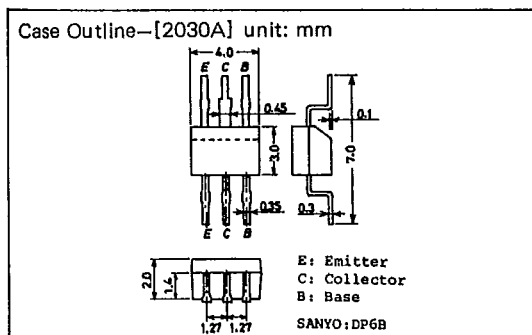
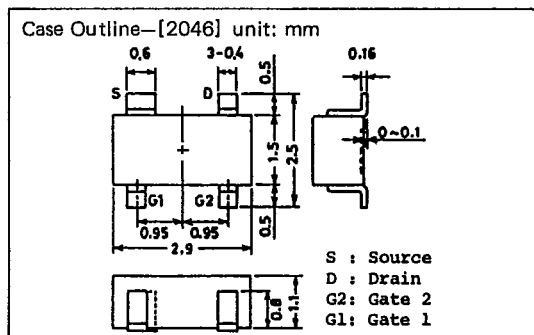
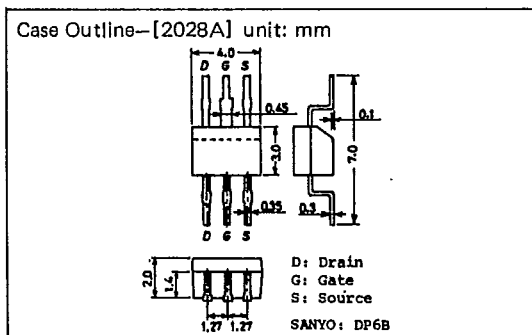
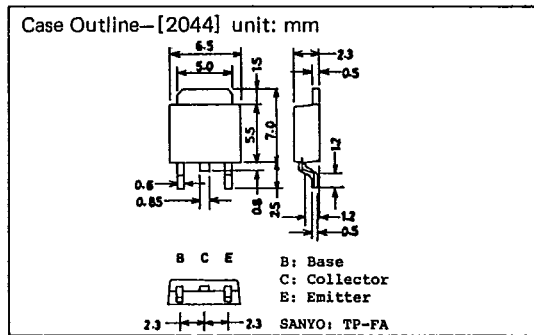
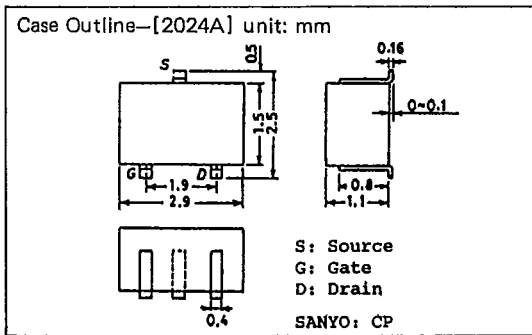
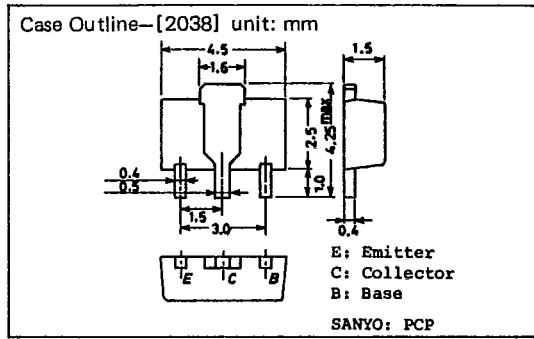
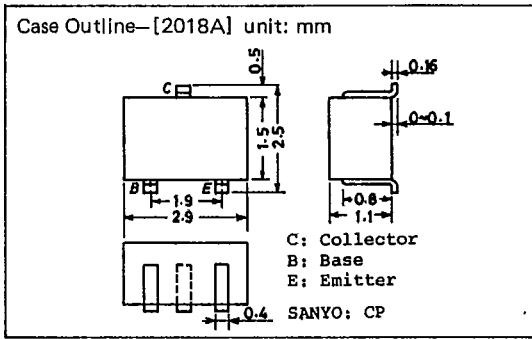

T-91-20

Case Outline—[2057] unit: mm

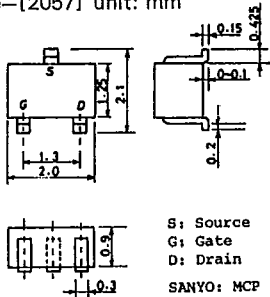

S: Source  
G: Gate  
D: Drain  
SANYO: MCP

Case Outline—[2066] unit: mm

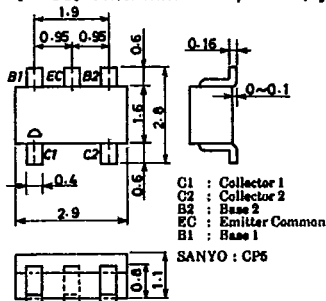

C1 : Collector 1  
C2 : Collector 2  
B2 : Base 2  
EC : Emitter Common  
B1 : Base 1  
SANYO : CP6

Case Outline—[2058] unit: mm

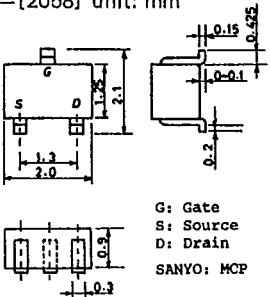

G: Gate  
S: Source  
D: Drain  
SANYO: MCP

Case Outline—[2067] unit: mm

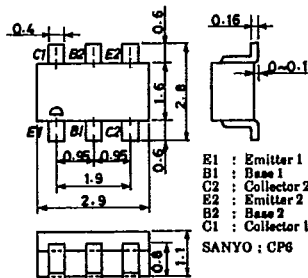

E1 : Emitter 1  
B1 : Base 1  
C2 : Collector 2  
E2 : Emitter 2  
B2 : Base 2  
C1 : Collector 1  
SANYO : CP6

Case Outline—[2059] unit: mm

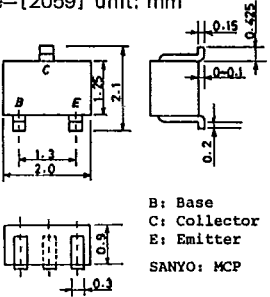

B: Base  
C: Collector  
E: Emitter  
SANYO: MCP

Case Outline—[2068] unit: mm

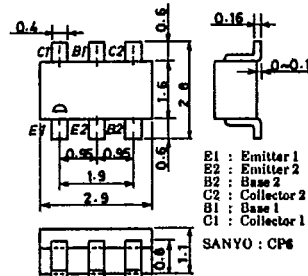

B1 : Emitter 1  
E2 : Emitter 2  
B2 : Base 2  
C2 : Collector 2  
B1 : Base 1  
C1 : Collector 1  
SANYO : CP6

Case Outline—[2062] unit: mm

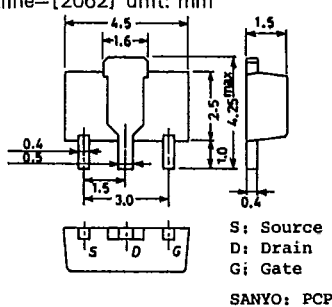

S: Source  
D: Drain  
G: Gate  
SANYO: PCP

Case Outline—[2069] unit: mm

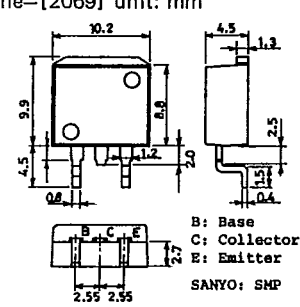

B: Base  
C: Collector  
E: Emitter  
SANYO: SMP

Case Outline—[2065] unit: mm

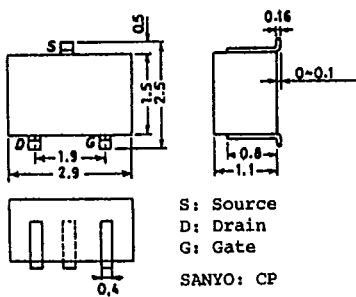

S: Source  
D: Drain  
G: Gate  
SANYO: CP

Case Outline—[2070] unit: mm

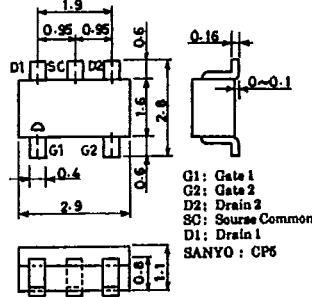

G1 : Gate 1  
G2 : Gate 2  
D2 : Drain 2  
SC : Source Common  
D1 : Drain 1  
SANYO : CP6

T-9120

