

# General purpose amplification (12V, 1.5A)

## 2SD2674

### ●Application

Low frequency amplifier

### ●Features

- 1) A collector current is large.
- 2) Collector saturation voltage is low.

$$V_{CE(sat)} \leq 200\text{mV}$$

$$\text{at } I_C = 500\text{mA} / I_B = 25\text{mA}$$

### ●External dimensions (Units : mm)

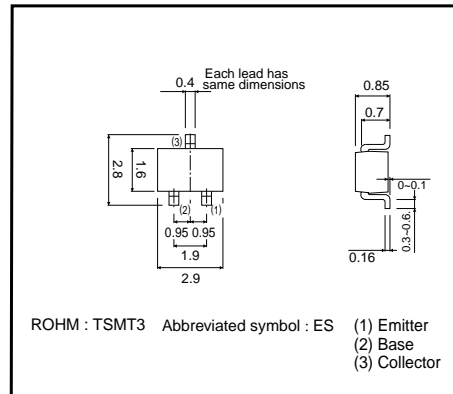

### ●Absolute maximum ratings (Ta=25°C)

Parameter	Symbol	Limits	Unit
Collector-base voltage	$V_{CB0}$	15	V
Collector-emitter voltage	$V_{CEO}$	12	V
Emitter-base voltage	$V_{EBO}$	6	V
Collector current	$I_C$	1.5	A
	$I_{CP}$	3	A *
Power dissipation	$P_C$	500	mW
Junction temperature	$T_j$	150	°C
Range of storage temperature	$T_{stg}$	-55~+150	°C

\*Single pulse,  $P_w=1\text{ms}$

### ●Packaging specifications

Type	Package	Taping
	Code	TL
	Basic ordering unit (pieces)	3000
2SD2674		○

### ●Electrical characteristics (Ta=25°C)

Parameter	Symbol	Min.	Typ.	Max.	Unit	Conditions
Collector-base breakdown voltage	$BV_{CB0}$	15	-	-	V	$I_C=10\mu\text{A}$
Collector-emitter breakdown voltage	$BV_{CEO}$	12	-	-	V	$I_C=1\text{mA}$
Emitter-base breakdown voltage	$BV_{EBO}$	6	-	-	V	$I_E=10\mu\text{A}$
Collector cutoff current	$I_{CBO}$	-	-	100	nA	$V_{CB}=15\text{V}$
Emitter cutoff current	$I_{EBO}$	-	-	100	nA	$V_{EB}=6\text{V}$
Collector-emitter saturation voltage	$V_{CE(sat)}$	-	85	200	mV	$I_C/I_B=500\text{mA}/25\text{mA}$
DC current gain	$h_{FE}$	270	-	680	-	$V_{CE}/I_C=2\text{V}/200\text{mA}$ *
Transition frequency	$f_r$	-	400	-	MHz	$V_{CE}=2\text{V}$ , $I_E=-200\text{mA}$ , $f=100\text{MHz}$ *
Collector output capacitance	$C_{ob}$	-	12	-	pF	$V_{CB}=10\text{V}$ , $I_E=0\text{A}$ , $f=1\text{MHz}$

\* Pulsed

Transistors

●Electrical characteristic curves

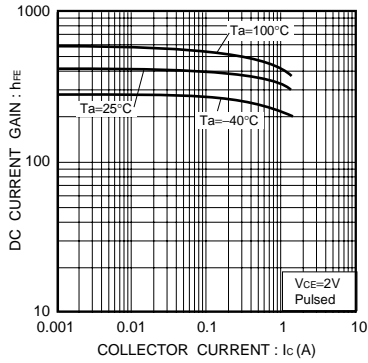

Fig.1 DC current gain vs. collector current

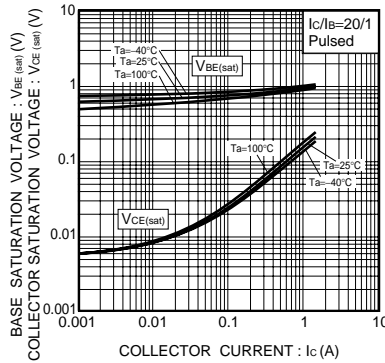

Fig.2 Collector-emitter saturation voltage vs. collector current

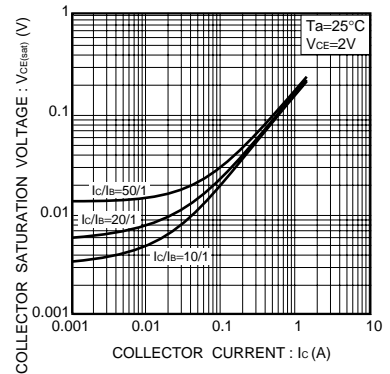

Fig.3 Collector-emitter saturation voltage vs. collector current

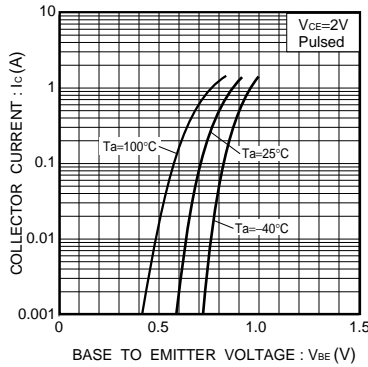

Fig.4 Grounded emitter propagation characteristics

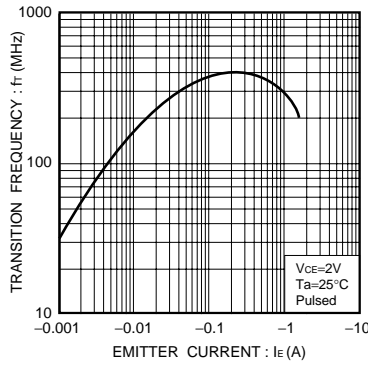

Fig.5 Gain bandwidth product vs. emitter current

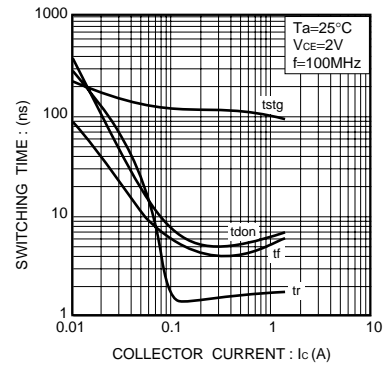

Fig.6 Switching time

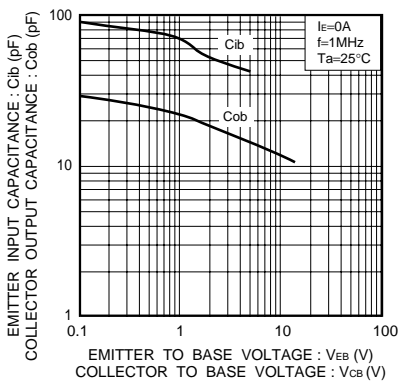

Fig.7 Collector output capacitance vs. collector-base voltage  
Emitter input capacitance vs. emitter-base voltage