



虹冠電子工業股份有限公司
Champion Microelectronic Corporation

Specialized in Integrated High Efficient Switching Power Management Solutions
高整合高效率交換型電源管理方案之專業IC設計



上海台永商貿有限公司

SHANGHAI TAIYONG CO.,LTD

上海市普陀區桐柏路165弄1號101-103室

(上海)TEL:86-21-59512136

(上海)FAX:86-21-59512123

E-mail: shanghai@shanghai-taiyong.com

E-mail: shanghai@vny-gsm.com

東莞辦事處

SHANGHAI TAIYONG CO.,LTD

東莞市長安鎮烏沙江貝村同和四巷15號

(東莞)TEL:86-769-5373287

(東莞)FAX:86-769-5373286

E-mail: dong-guan@shanghai-taiyong.com

E-mail: dong-guan@vny-gsm.com

GENERAL DESCRIPTION

The CM2831 family is a positive voltage linear regulator developed utilizing CMOS technology featured low quiescent current (30µA typ.), low dropout voltage, and high output voltage accuracy, making them ideal for battery applications. EN input connected to CMOS has low bias current. The space-saving SOT-23-5 package is attractive for “Pocket” and “Hand Held” applications.

These rugged devices have both Thermal Shutdown, and Current Fold-back to prevent device failure under the “Worst” of operating conditions.

In application requiring a low noise, regulated supply, place a 1000pF capacitor between Bypass and Ground.

The CM2831 is stable with an output capacitance of 2.2µF or greater.

FEATURES

- ◆ Very Low Dropout Voltage
- ◆ Low Current Consumption: Typ. 30µA, Max. 35µA
- ◆ Output Voltage: 1.5V, 1.8V, 1.9V, 2.2V, 2.5V, 2.7V, 2.8V, 2.9V, 3.0V, 3.3V, 3.5V, 3.6V, and 3.8V
- ◆ High Accuracy Output Voltage: +/- 1.5%
- ◆ Guaranteed 300mA Output
- ◆ Input Range of 2.6V to 7.0V
- ◆ Thermal Shutdown
- ◆ Current Limiting
- ◆ Compact Package: SOT-23-5
- ◆ Factory Pre-set Output Voltages
- ◆ Short Circuit Current Fold-Back
- ◆ Low Temperature Coefficient

APPLICATIONS

- ◆ Battery-powered devices
- ◆ Personal communication devices
- ◆ Home electric/electronic appliances
- ◆ PC peripherals

24 Hours Technical Support--WebSIM

Champion provides customers an online circuit simulation tool called WebSIM. You could simply logon our website at www.champion-micro.com for details.

TYPICAL APPLICATIONS

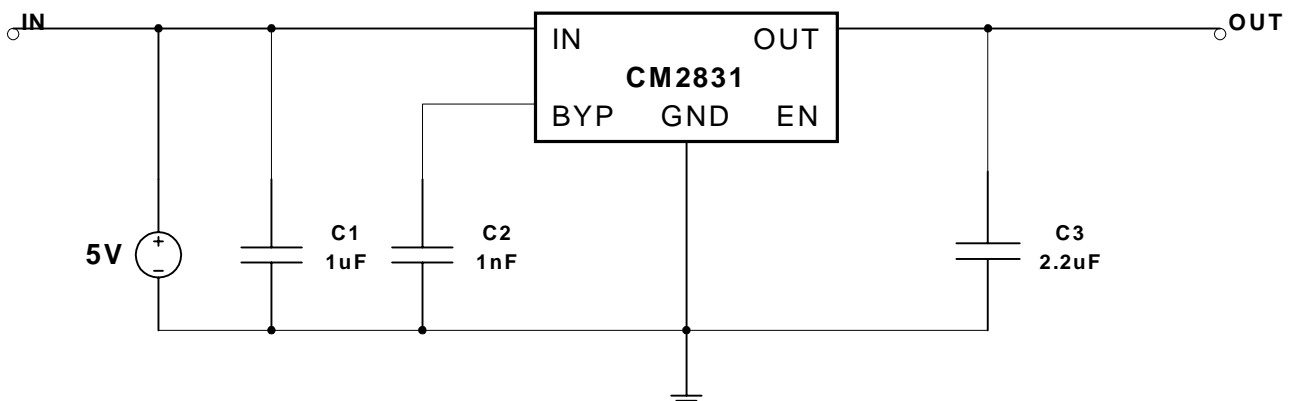

PIN CONFIGURATION

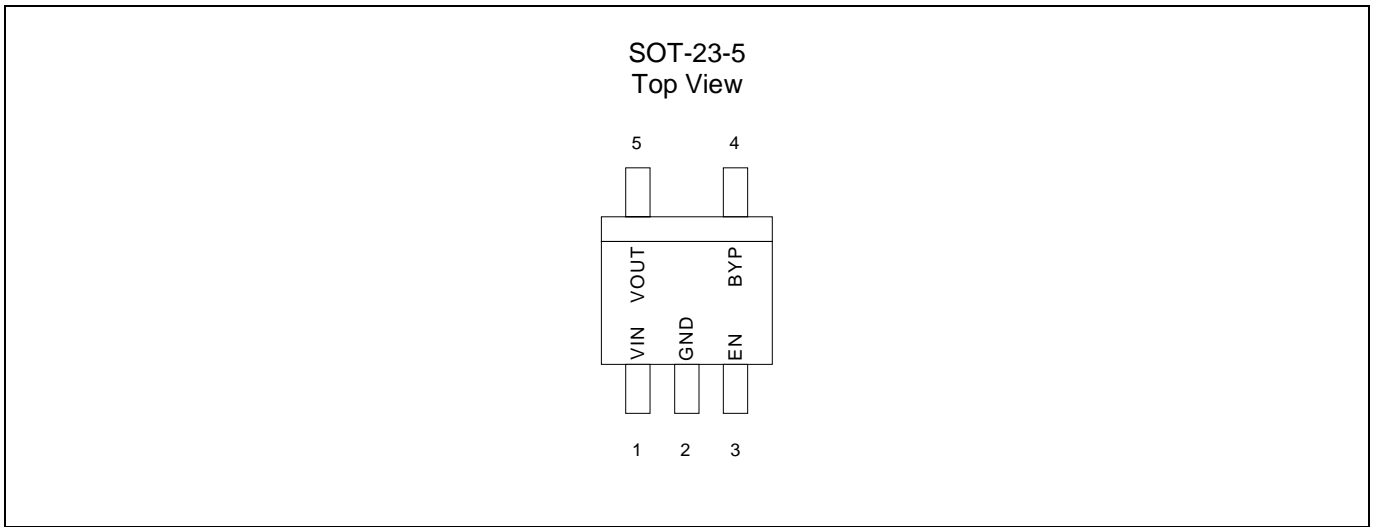

BLOCK DIAGRAM

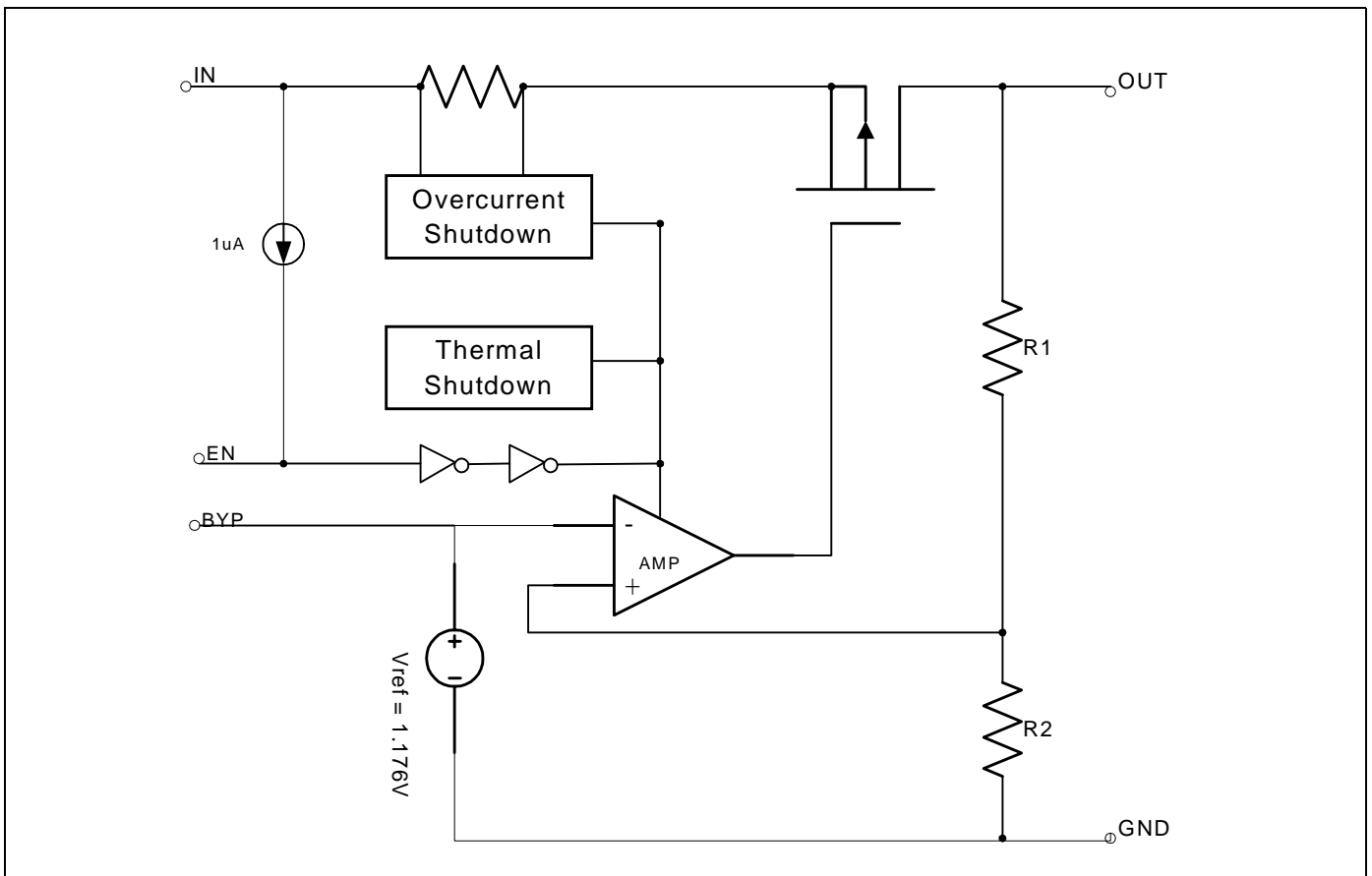

ORDERING INFORMATION

Part Number	Output Voltage	Temperature Range	Package
CM2831AIM25	1.5V	-40°C ~ +85°C	SOT-23-5
CM2831DIM25	1.8V	-40°C ~ +85°C	SOT-23-5
CM2831EIM25	1.9V	-40°C ~ +85°C	SOT-23-5
CM2831HIM25	2.2V	-40°C ~ +85°C	SOT-23-5
CM2831KIM25	2.5V	-40°C ~ +85°C	SOT-23-5
CM2831MIM25	2.7V	-40°C ~ +85°C	SOT-23-5
CM2831NIM25	2.8V	-40°C ~ +85°C	SOT-23-5
CM2831OIM25	2.9V	-40°C ~ +85°C	SOT-23-5
CM2831PIM25	3.0V	-40°C ~ +85°C	SOT-23-5
CM2831SIM25	3.3V	-40°C ~ +85°C	SOT-23-5
CM2831UIM25	3.5V	-40°C ~ +85°C	SOT-23-5
CM2831VIM25	3.6V	-40°C ~ +85°C	SOT-23-5
CM2831XIM25	3.8V	-40°C ~ +85°C	SOT-23-5

Note: For other pre-set output voltage requirements, please contact Champion Sales office.

ABSOLUTE MAXIMUM RATINGS

Input Voltage +7V
Output Current $P_D / (V_{IN} - V_o)$ mA
Output Voltage GND-0.3V to $V_{IN}+0.3V$
ESD Classification B

OPERATING RATINGS

Ambient Temperature Range (T_A) -40°C to +85°C
Junction Temperature Range -40°C to +125°C

THERMAL INFORMATION

Parameter		Maximum	Unit
Thermal Resistance (θ_{jc})	SOT-23-5	260	°C/W
Internal Power Dissipation (P_D) ($\Delta T = 100^\circ\text{C}$)	SOT-23-5	380	°C/W
Maximum Junction Temperature		150	°C
Maximum Lead Temperature (10 Sec)		300	°C

Caution: Stress above the listed absolute rating may cause permanent damage to the device.

ELECTRICAL CHARACTERISTICS

$T_A = +25^\circ\text{C}$; unless otherwise noted

Parameter	Symbol	Test Conditions	CM2831			Unit	
			Min.	Typ.	Max.		
Input Voltage	V_{IN}		Note 1		7	V	
Output Voltage Accuracy	V_{OUT}	$I_O = 1\text{mA to } 300\text{mA}$	-1.5		1.5	%	
Dropout Voltage	$V_{DROPOUT}$	$I_O = 300\text{mA}, V_{OUT}=V_{O(NOM)}-2\%, V_{OUT}\geq 2.5\text{V}$		300		mV	
		$I_O = 300\text{mA}, V_{OUT}=V_{O(NOM)}-2\%, V_{OUT}< 2.5\text{V}$		800			
Output Current	I_O	$V_{OUT} > 1.2\text{V}$	300			mA	
Current Limit	I_{LIM}	$V_{OUT} > 1.2\text{V}$	300	450		mA	
Short Circuit Current	I_{SC}	$V_{OUT} < 0.95\text{V}$		150	300	mA	
Quiescent Current	I_Q	$I_O = 0\text{mA}$		30	35	μA	
Ground Pin Current	I_{GND}	$I_O = 1\text{mA to } 300\text{mA}$		30	50	μA	
Line Regulation	REG_{LINE}	$I_{OUT}=5\text{mA}, V_{IN}=V_{OUT}+1$ to $V_{OUT}+2$	$V_{OUT} \leq 3.0\text{V}$	-0.15	0.03	0.15	%
			$V_{OUT} > 3.0\text{V}$	-0.3	0.06	0.3	%
Load Regulation	REG_{LOAD}	$I_O=1\text{mA to } 300\text{mA}$		0.2	1	%	
Over Temperature Shutdown	OTS			150		$^\circ\text{C}$	
Over Temperature Hysteresis	OTH			30		$^\circ\text{C}$	
V_{OUT} Temperature Coefficient	TC			25		ppm/ $^\circ\text{C}$	
Power Supply Rejection	PSRR	$I_O = 100\text{mA}$ $C_O=2.2\mu\text{F}$ ceramic	$f=1\text{kHz}$		60		dB
			$f=10\text{kHz}$		50		
			$f=100\text{kHz}$		40		
Power Supply Rejection	PSRR	$I_O = 100\text{mA}$ $C_O=2.2\mu\text{F}$ ceramic $C_{BYP}=0.01\mu\text{F}$	$f=1\text{kHz}$		75		dB
			$f=10\text{kHz}$		55		
			$f=100\text{kHz}$		30		
Output Voltage Noise	eN	$f=10\text{Hz to } 100\text{kHz}$ $I_O = 10\text{mA}, C_{BYP}=0\mu\text{F}$	$C_O=2.2\mu\text{F}$		30		μVrms
			$C_O=100\mu\text{F}$		20		
Output Voltage Noise	eN	$f=10\text{Hz to } 100\text{kHz}$ $I_O = 10\text{mA}, C_{BYP}=0.01\mu\text{F}$	$C_O=2.2\mu\text{F}$		30		μVrms
			$C_O=100\mu\text{F}$		20		
Shutdown Supply Current	I_{SD}	$V_{IN}=5.0\text{V}, V_{OUT}=0\text{V}, V_{EN} < V_{EL}$		2.0	3.0	μA	
EN Input Bias Current	I_{EH}	$V_{EN}=V_{IN}, V_{IN}=2.6\text{V to } 7\text{V}$			0.1	μA	
	I_{EL}	$V_{EN}=V_{IN}, V_{IN}=2.6\text{V to } 7\text{V}$		1.0	3.0	μA	
EN Input Threshold	V_{EH}	$V_{IN}=2.6\text{V to } 7\text{V}$		$V_{IN}/2+0.8\text{V}$	V_{IN}	V	
	V_{EL}	$V_{IN}=2.6\text{V to } 7\text{V}$	0	$V_{IN}/2-0.8\text{V}$		V	

Note 1. $V_{IN(MIN)} = V_{OUT} + V_{DROPOUT}$

DETAILED DESCRIPTION

The CM2831 family of CMOS regulators contain a PMOS pass transistor, voltage reference, error amplifier, over-current protection, thermal shutdown, and short circuit protection.

The P-channel pass transistor receives data from the error amplifier, over-current shutdown, short output protection, and thermal protection circuits. During normal operation, the error amplifier compares the output voltage to a precision reference. Over-current and Thermal shutdown circuits become active when the junction temperature exceeds 150°C, or the current exceeds 300mA. During thermal shutdown, the output voltage remains low. Normal operation is restored when the junction temperature drops below 120°C.

The CM2831 switches from voltage mode to current mode when the load exceeds the rated output current. This prevents over-stress. The CM2831 also incorporates current fold-back to reduce power dissipation when the output is short-circuited. This feature becomes active when the output drops below 1.05V, and reduces the current flow by 65%. Full current is restored when the voltage exceeds 0.95V.

ENABLE

The Enable pin normally floats high. When actively, pulled low, the PMOS pass transistor shut off, and all internal circuits are powered down. In this state, the quiescent current is less than 2μA. This pin behaves much like an electronic switch.

EXTERNAL CAPACITOR

The CM2831 is stable with an output capacitor to ground of 2.2μF or greater. It can keep stable even with higher or poor ESR capacitors. A second capacitor is recommended between the input and ground to stabilize VIN. The input capacitor should be larger than 0.1μF to have a beneficial effect. All capacitors should be placed in close proximity to the pins. A “quiet” ground termination is desirable.

TYPICAL ELECTRICAL CHARACTERISTICS

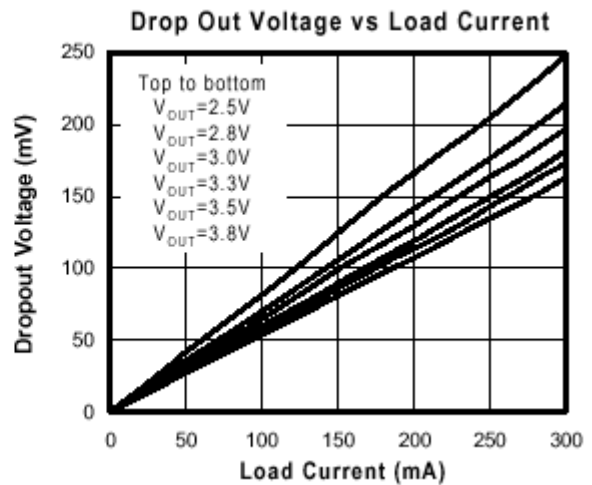
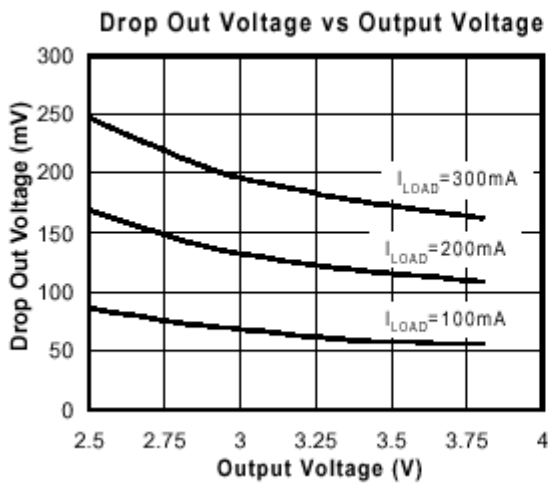
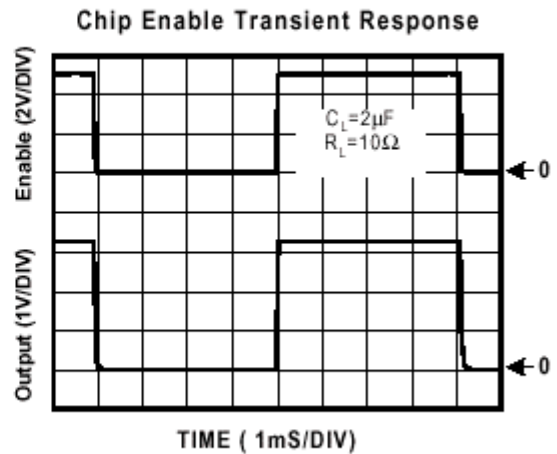
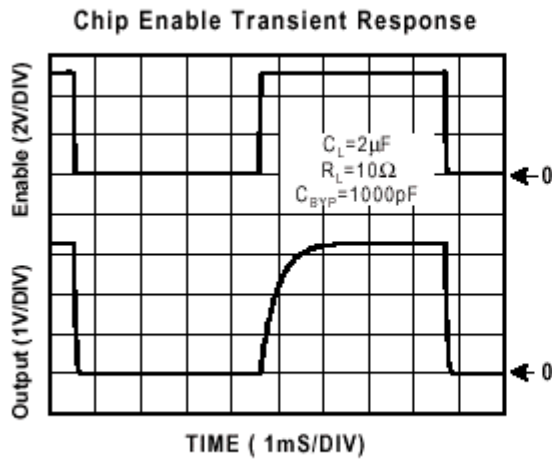
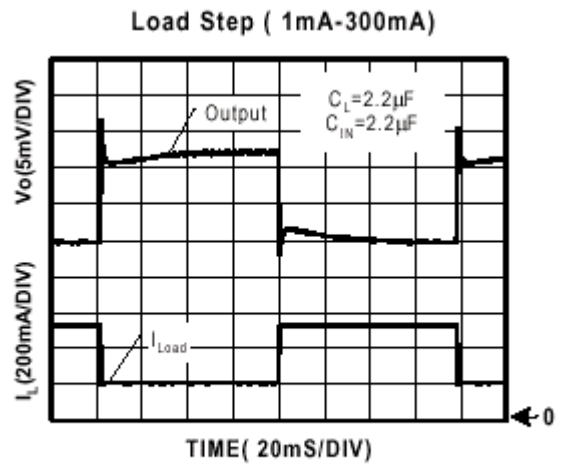
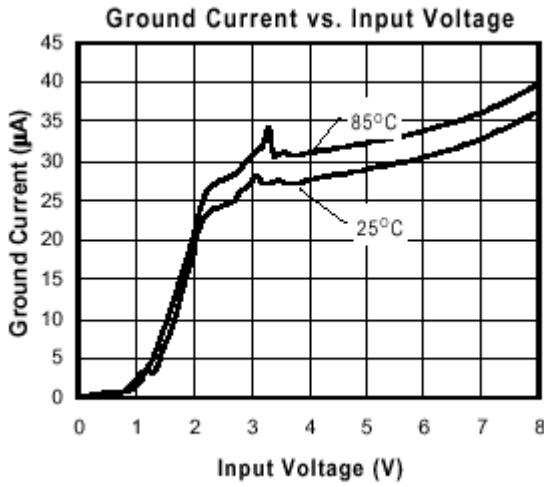

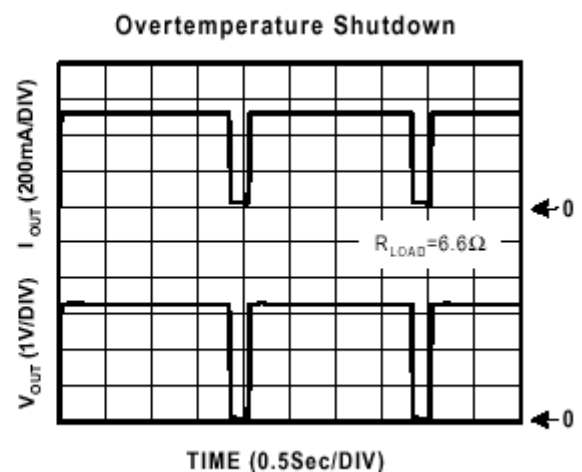
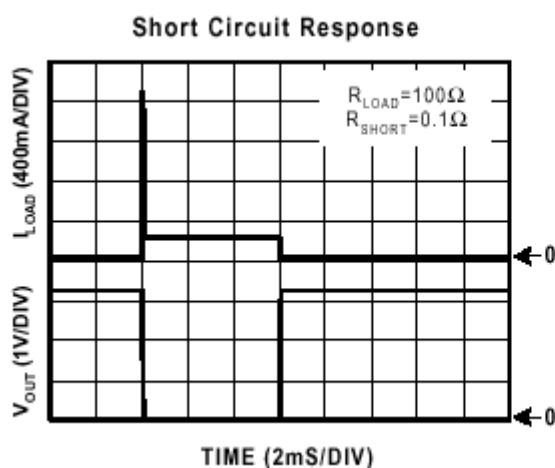
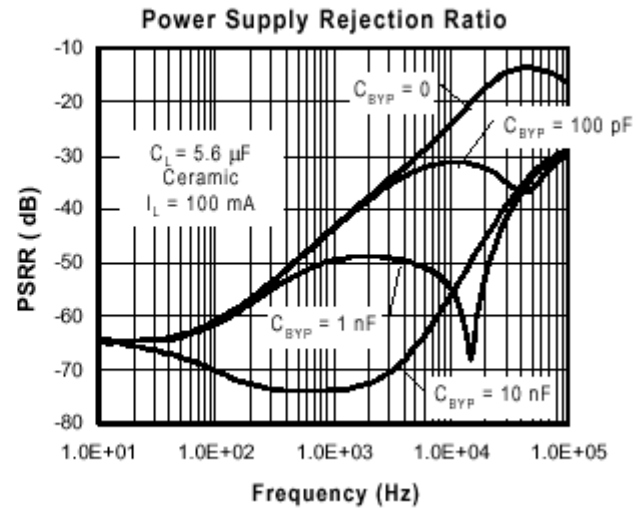
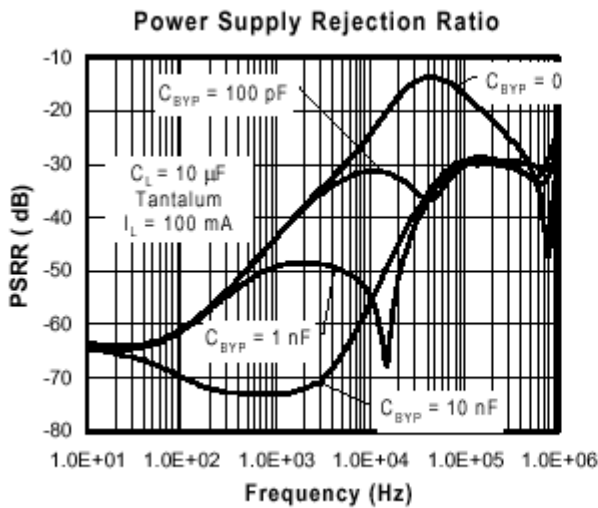
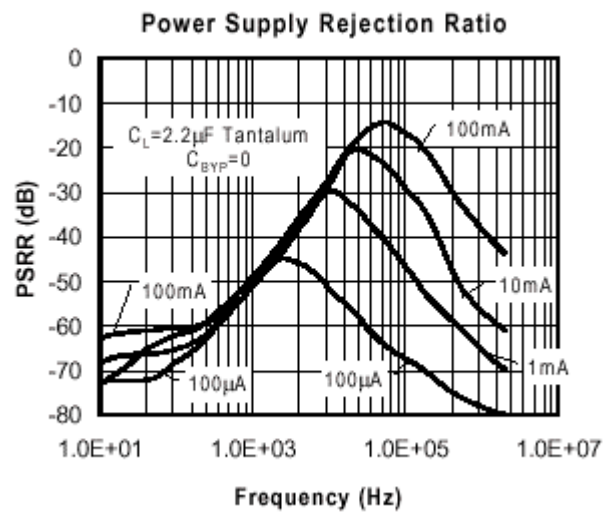
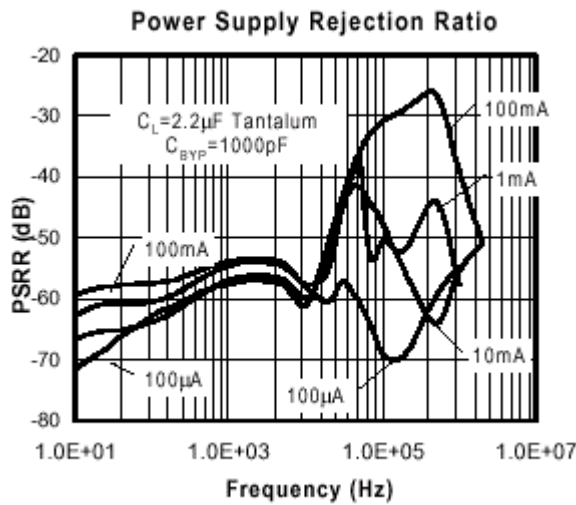

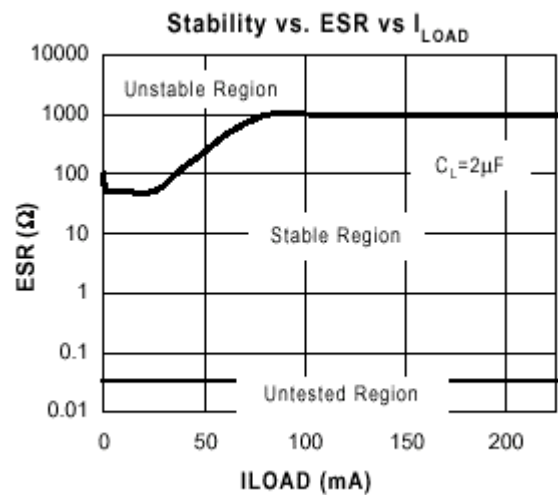
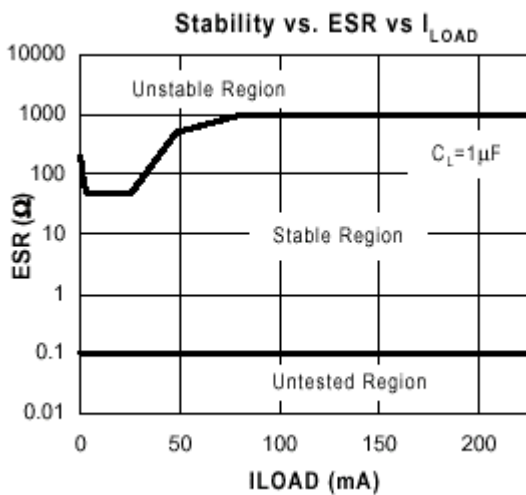
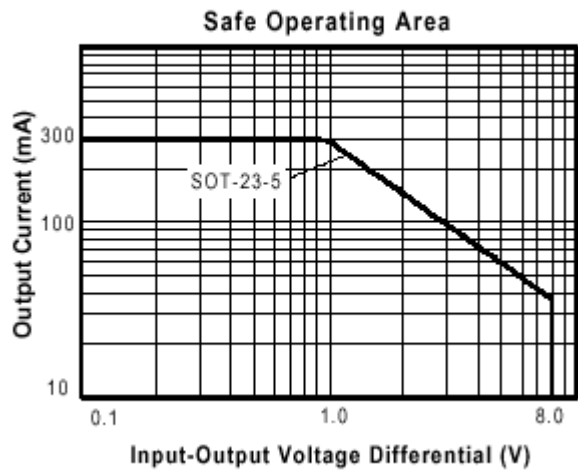
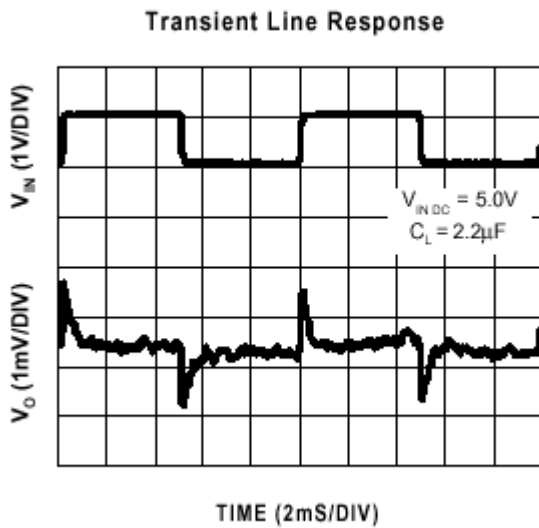
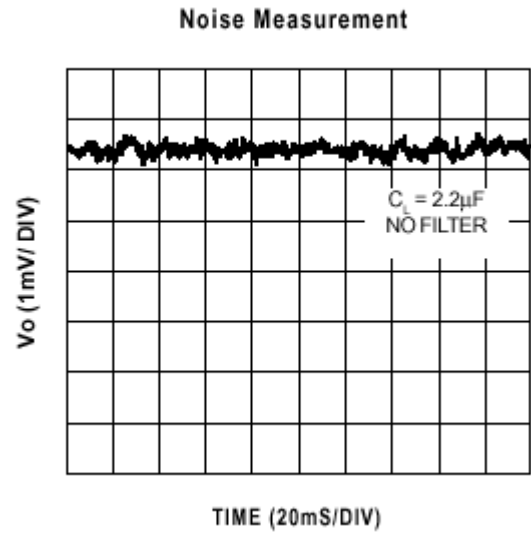
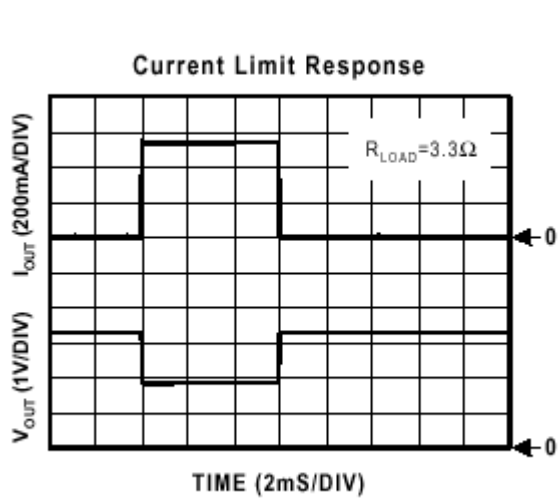

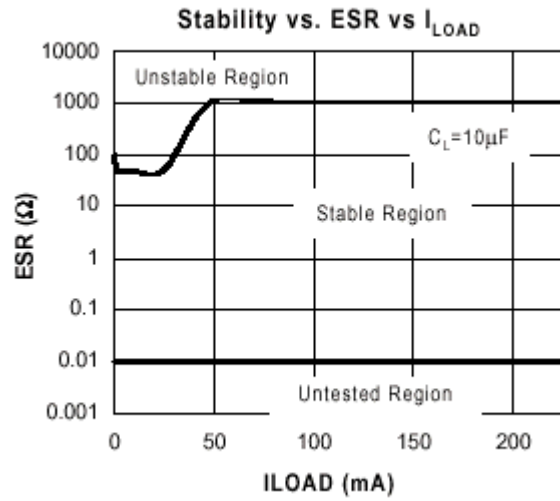
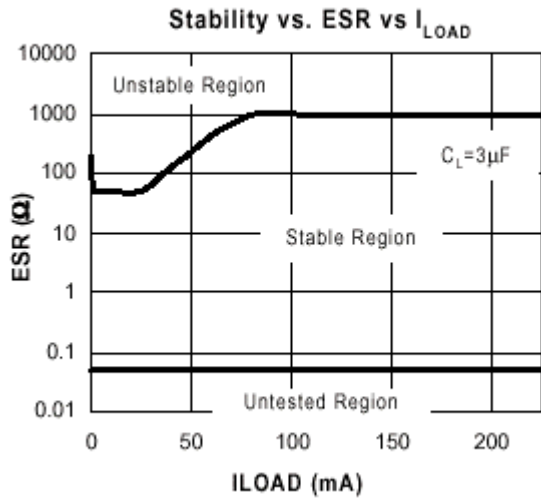

PACKAGE DIMENSION

SOT-23-5 (M25)

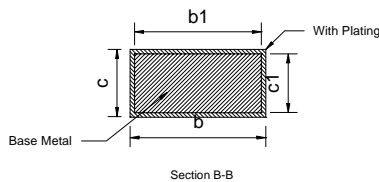
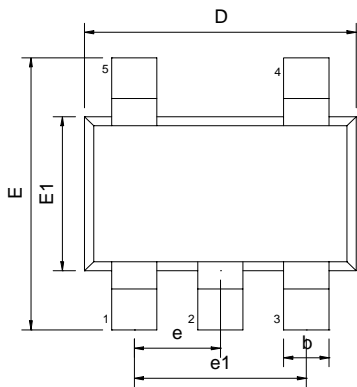

SYMBOLS	DIMENSIONS IN MILLIMETERS			DIMENSIONS IN INCHES		
	MIN	NOM	MAX	MIN	NOM	MAX
A	1.05	---	1.35	0.041	---	0.053
A1	0.05	---	0.15	0.002	---	0.006
A2	1.00	1.10	1.20	0.039	0.043	0.047
b	0.25	---	0.50	0.010	---	0.020
b1	0.25	0.40	0.45	0.010	0.016	0.018
c	0.08	---	0.20	0.003	---	0.008
c1	0.08	0.11	0.15	0.003	0.004	0.006
D	2.70	2.90	3.00	0.106	0.114	0.118
E	2.60	2.80	3.00	0.102	0.110	0.118
E1	1.50	1.60	1.70	0.059	0.063	0.067
L	0.35	0.45	0.55	0.014	0.018	0.022
L1	0.60 REF			0.024 REF		
e	0.95 BSC			0.037 BSC		
e1	1.90 BSC			0.075 BSC		
θ	0°	5°	10°	0°	5°	10°
θ1	3°	5°	7°	3°	5°	7°
θ2	6°	8°	10°	6°	8°	10°

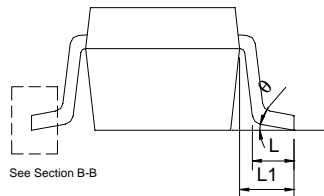
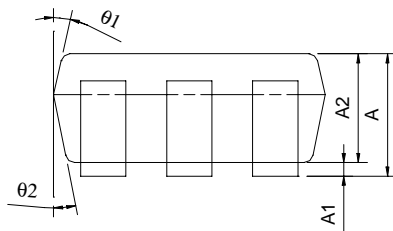

NUMBERING SCHEME

Ordering Number: CM2831XYZ (note1)

note1:

CM2831 : 300mA CMOS LDO with enable

X : Suffix for voltage output (note 2)

Y : Suffix for Temperature Range (note 3)

Z : Suffix for Package Type (note 4)

note 2: see CMOS LDO Voltage Suffix Table

CM2831 will provide options of A(1.5V), D (1.8V), E(1.9V),, H(2.2V), K(2.5V), M(2.7V), N(2.8V), O(2.9V), P(3.0V), S(3.3V), U(3.5V), V(3.6V), X(3.8V)

note 3:

Y= I : -40°C ~+85°C (only I grade support for all CMOS LDOs)

note 4:

Z is single alphabet with or without digits

M25 : SOT-25 (TR only)

CMOS LDO Voltage Suffix Table

Output Voltage	Suffix	Output Voltage	Suffix
1.5V	A	3.0V	P
1.6V	B	3.1V	Q
1.7V	C	3.2V	R
1.8V	D	3.3V	S
1.9V	E	3.4V	T
2.0V	F	3.5V	U
2.1V	G	3.6V	V
2.2V	H	3.7V	W
2.3V	I	3.8V	X
2.4V	J	3.9V	Y
2.5V	K	4.0V	Z
2.6V	L		
2.7V	M		
2.8V	N		
2.9V	O		

上海台永商貿有限公司



SHANGHAI SALES DEPT.

上海台永商貿有限公司
SHANGHAI TAIYONG CO.,LTD
上海市普陀區桐柏路 165 弄 1 號
101-103 室

(上海)TEL:86-21-59512136

(上海)FAX:86-21-59512123

E-mail:

shanghai@shanghai-taiyong.com

E-mail:

shanghai@vny-gsm.com



INVERTER LAB & Sales Dept . DONG-GUAN,CHINA

東省東莞市長安鎮烏沙江貝村同和
四巷 15 號

(東莞) TEL:86-769-5373287

(東莞) FAX:86-769-5373286

E-mail:

dong-guan@shanghai-taiyong.com

E-mail:

dong-guan@vny-gsm.com



CERAMIC/SURGE ABSORBER SHANGHAI,CHINA



DIODES LAB HANGZHOU,CHINA



CERAMIC/PZT SHINCHU,TAIWAN



DC POWER LAB TAIPEI,TAIWAN