



**CHENMKO ENTERPRISE CO.,LTD**

**2N7002S**

**SURFACE MOUNT**

**Dual N-Channel Enhancement MOS FET**

**VOLTAGE 60 Volts CURRENT 0.250 Ampere**

**APPLICATION**

- \* Servo motor control.
- \* Power MOSFET gate drivers.
- \* Other switching applications.

**FEATURE**

- \* Small surface mounting type. (SC-88/SOT-363)
- \* High density cell design for low  $R_{DS(ON)}$ .
- \* Suitable for high packing density.
- \* Rugged and reliable.
- \* High saturation current capability.
- \* Voltage controlled small signal switch.

**CONSTRUCTION**

- \* Dual N-Channel Enhancement

**MARKING**

- \* 702S



**SC-88/SOT-363**

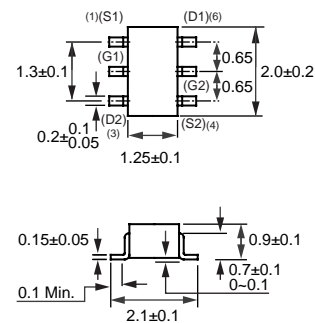

Dimensions in millimeters

**SC-88/SOT-363**

**CIRCUIT**

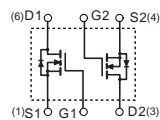

**Absolute Maximum Ratings**  $T_A = 25^\circ\text{C}$  unless otherwise noted

Symbol	Parameter	2N7002S	Units
$V_{DSS}$	Drain-Source Voltage	60	V
$V_{DGR}$	Drain-Gate Voltage ( $R_{GS} \leq 1 \text{ M}\Omega$ )	60	V
$V_{GSS}$	Gate-Source Voltage - Continuous - Non Repetitive ( $t_p < 50\mu\text{s}$ )	$\pm 20$	V
		$\pm 40$	
$I_D$	Maximum Drain Current - Continuous - Pulsed	$T_A = 25^\circ\text{C}$ 250	mA
		$T_A = 70^\circ\text{C}$ 190	
$P_D$	Maximum Power Dissipation	$T_A = 25^\circ\text{C}$ 350	mW
		$T_A = 70^\circ\text{C}$ 220	mW
$T_J, T_{STG}$	Operating and Storage Temperature Range	-55 to 150	$^\circ\text{C}$
$T_L$	Maximum Lead Temperature for Soldering Purposes, 1/16" from Case for 10 Seconds	300	$^\circ\text{C}$

**Thermal characteristics**

$R_{\theta JA}$	Thermal Resistance, Junction-to-Ambient	450	$^\circ\text{C/W}$
-----------------	---	-----	--------------------

## RATING CHARACTERISTIC CURVES ( 2N7002S )

**Electrical Characteristics**  $T_A = 25^\circ\text{C}$  unless otherwise noted

Symbol	Parameter	Conditions	Min	Typ	Max	Units
--------	-----------	------------	-----	-----	-----	-------

### OFF CHARACTERISTICS

$BV_{DSS}$	Drain-Source Breakdown Voltage	$V_{GS} = 0\text{ V}, I_D = 10\ \mu\text{A}$	60	70		V
$I_{DSS}$	Zero Gate Voltage Drain Current	$V_{DS} = 60\text{ V}, V_{GS} = 0\text{ V}$			1	$\mu\text{A}$
		$T_C = 125^\circ\text{C}$			0.5	mA
$I_{GSSF}$	Gate - Body Leakage, Forward	$V_{GS} = 15\text{ V}, V_{DS} = 0\text{ V}$			10	nA
$I_{GSSR}$	Gate - Body Leakage, Reverse	$V_{GS} = -15\text{ V}, V_{DS} = 0\text{ V}$			-10	nA

### ON CHARACTERISTICS (Note 1)

$V_{GS(th)}$	Gate Threshold Voltage	$V_{DS} = V_{GS}, I_D = 250\ \mu\text{A}$	1	2.0	2.5	V
$R_{DS(on)}$	Static Drain-Source On-Resistance	$V_{GS} = 10\text{ V}, I_D = 250\text{ mA}$		1.7	3.0	$\Omega$
		$V_{GS} = 4.0\text{ V}, I_D = 100\text{ mA}$		2.5	4.0	
$V_{DS(on)}$	Drain-Source On-Voltage	$V_{GS} = 10\text{ V}, I_D = 500\text{ mA}$		0.6	3.75	V
		$V_{GS} = 5.0\text{ V}, I_D = 50\text{ mA}$		0.09	1.5	
$I_{D(on)}$	On-State Drain Current	$V_{GS} = 10\text{ V}, V_{DS} = 7.5V_{DS(on)}$	800	1300		mA
		$V_{GS} = 4.5\text{ V}, V_{DS} = 10V_{DS(on)}$	500	700		
$g_{FS}$	Forward Transconductance	$V_{DS} = 15\text{ V}, I_D = 200\text{ mA}$		250		mS

### DYNAMIC CHARACTERISTICS

$Q_g$	Total Gate Charge	$V_{DS} = 30\text{ V}, V_{GS} = 10\text{ V},$ $I_D = 250\text{ mA}$		0.6	1.0	nC
$Q_{gs}$	Gate-Source Charge			0.06	25	
$Q_{gd}$	Gate-Drain Charge			0.06	5	
$C_{iss}$	Input Capacitance	$V_{DS} = 25\text{ V}, V_{GS} = 0\text{ V},$ $f = 1.0\text{ MHz}$		25	50	pF
$C_{oss}$	Output Capacitance			6	25	
$C_{rss}$	Reverse Transfer Capacitance			1.2	5	
$t_{on}$	Turn-On Time	$V_{DD} = 30\text{ V}, R_L = 200\ \Omega,$ $I_D = 100\text{ mA}, V_{GS} = 10\text{ V},$ $R_{GEN} = 10\ \Omega$		7.5	20	nS
$t_r$				6		
$t_{off}$	Turn-Off Time	$V_{DD} = 30\text{ V}, R_L = 200\ \Omega,$ $I_D = 100\text{ mA}, V_{GS} = 10\text{ V},$ $R_{GEN} = 10\ \Omega$		7.5	20	nS
$t_f$				3		

### DRAIN-SOURCE DIODE CHARACTERISTICS AND MAXIMUM RATINGS

$I_S$	Maximum Continuous Drain-Source Diode Forward Current			115	mA	
$I_{SM}$	Maximum Pulsed Drain-Source Diode Forward Current			0.8	A	
$V_{SD}$	Drain-Source Diode Forward Voltage	$V_{GS} = 0\text{ V}, I_S = 200\text{ mA}$ (Note 1)		0.85	1.2	V

Note:

1. Pulse Test: Pulse Width < 300 $\mu\text{s}$ , Duty Cycle < 2.0%.

# RATING CHARACTERISTIC CURVES ( 2N7002S )

## Typical Electrical Characteristics

Figure 1. On-Region Characteristics

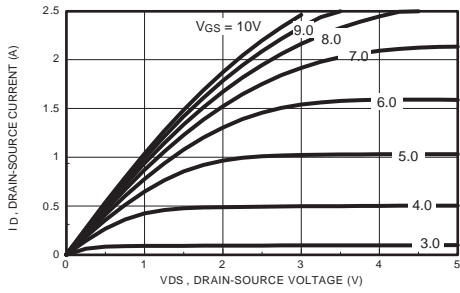

Figure 2. On-Resistance Variation with Gate Voltage and Drain Current

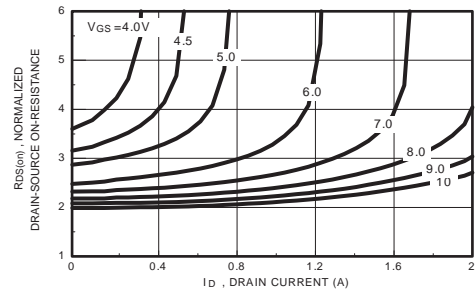

Figure 3. On-Resistance Variation with Temperature

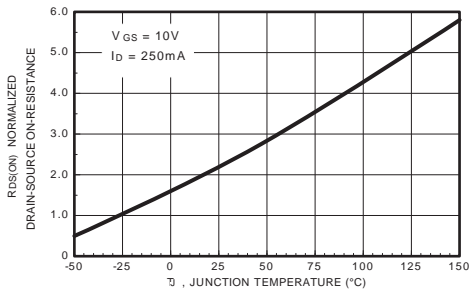

Figure 4. On-Resistance Variation with Drain Current and Temperature

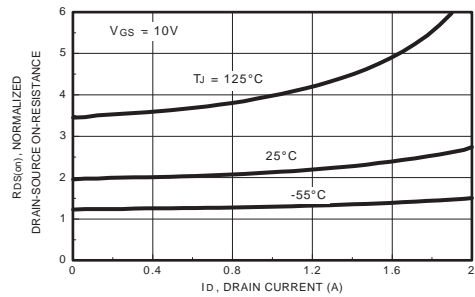

Figure 5. Transfer Characteristics

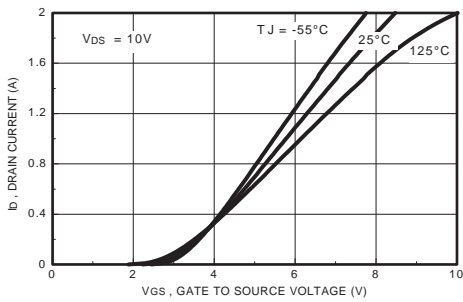
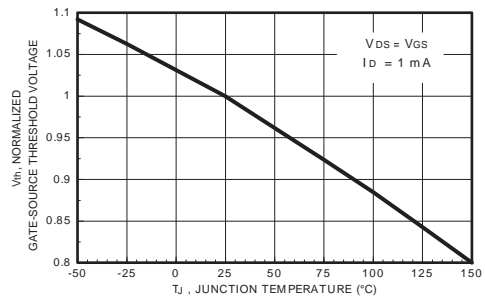

Figure 6. Gate Threshold Variation with Temperature



# RATING CHARACTERISTIC CURVES ( 2N7002S )

## Typical Electrical Characteristics (continued)

**Figure 7. Breakdown Voltage Variation with Temperature**

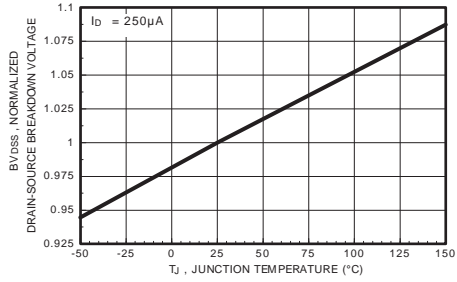

**Figure 8. Body Diode Forward Voltage Variation with Drain Current**

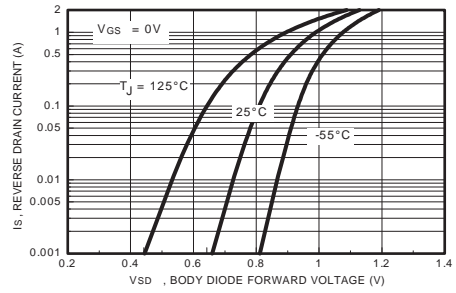

**Figure 9. Capacitance Characteristics**

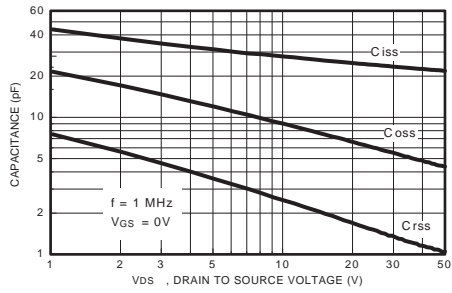

**Figure 10. Gate Charge Characteristics**

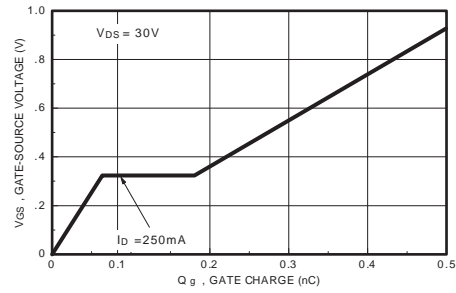

**Figure 11.**

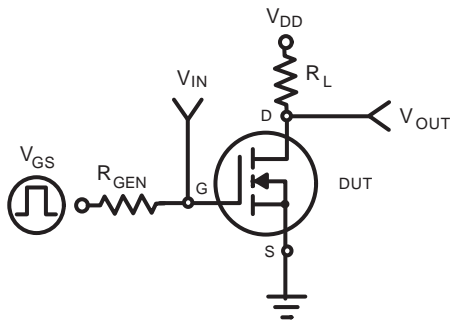

**Figure 12. Switching Waveforms**

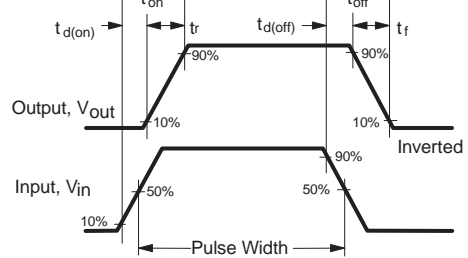

# RATING CHARACTERISTIC CURVES ( 2N7002S )

## Typical Electrical Characteristics (continued)

Figure 13. 2N7002S Maximum Safe Operating Area

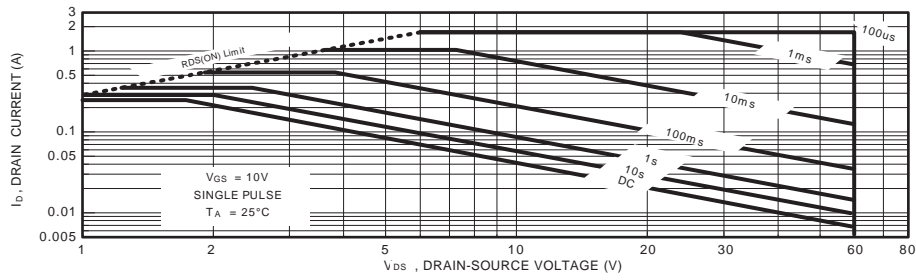

Figure 14. 2N7002S Transient Thermal Response Curve

