

APPLICATION MANUAL

LDO Regulator with base terminal for Current Boost TK714xxS

CONTENTS

1 . DESCRIPTION	2
2 . FEATURES	2
3 . APPLICATIONS	2
4 . PIN CONFIGURATION	2
5 . BLOCK DIAGRAM	2
6 . ORDERING INFORMATION	3
7 . ABSOLUTE MAXIMUM RATINGS	4
8 . ELECTRICAL CHARACTERISTICS	4
9 . TEST CIRCUIT	5
10 . TYPICAL CHARACTERISTICS	7
11 . PIN DESCRIPTION	15
12 . APPLICATIONS INFORMATION	15
13 .Outline : PCB : Stamps	19
14 . NOTES	20
15 . OFFICES	20



LDO Regulator with base terminal for Current Boost TK714xxS

1. DESCRIPTION

The TK714xxS is a low dropout linear regulator with internal PNP pass transistor that can supply 100mA load current. The phase compensation in the IC has been optimized that the output capacitor can be omitted.

The TK714xxS is provided with the On/Off control function and also with the base terminal for the external transistor that 1A low dropout regulator can be easily composed by connecting external transistor (Hfe around 100).

2. FEATURES

- An external transistor can be used.
(Base current Typ10mA)
- On/Off control available (High ON).
- No input current at Off mode
- Excellent output stability (CL 0.022μF, Iout 2mA)
- High ripple rejection (-70dB at 1kHz)
- 100mA load current guarantee
- Output voltage available from 1.3 to 5.0V (0.1V step).

3. APPLICATIONS

- Electronic Equipment
- Battery Powered Systems
Mobile communications, etc.

4. PIN CONFIGURATION

TOP VIEW

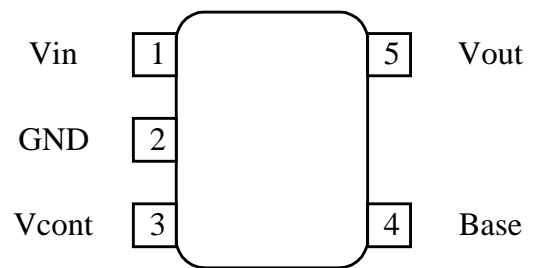

5. BLOCK DIAGRAM

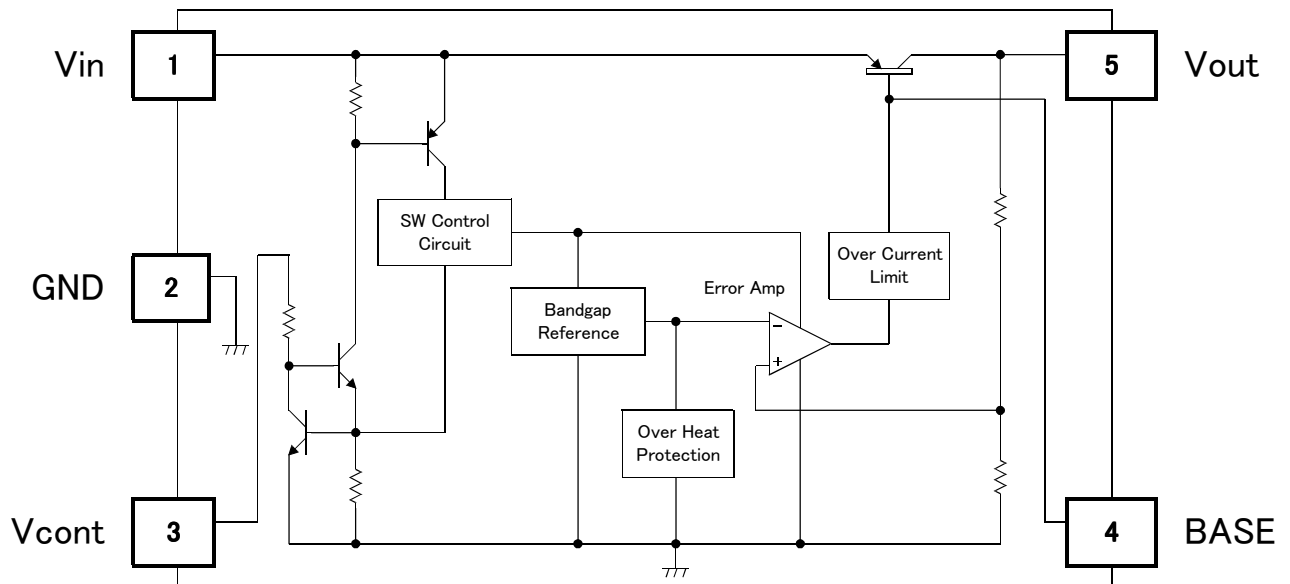

6. ORDERING INFORMATION

ORDERING INFORMATION

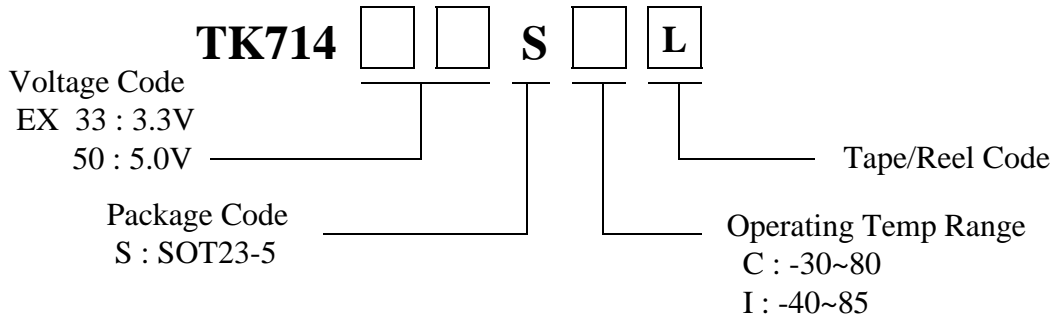

Standard voltage (net multiplication bold-faced type)

			TK71413S	TK71414S
TK71415S	TK71416S	TK71417S	TK71418S	TK71419S
TK71420S	TK71421S	TK71422S	TK71423S	TK71424S
TK71425S	TK71426S	TK71427S	TK71428S	TK71429S
TK71430S	TK71431S	TK71432S	TK71433S	TK71434S
TK71435S	TK71436S	TK71437S	TK71438S	TK71439S
TK71440S	TK71441S	TK71442S	TK71443S	TK71444S
TK71445S	TK71446S	TK71447S	TK71448S	TK71449S
TK71450S				

*Please contact your authorized TOKO representatives for voltage availability.

7. ABSOLUTE MAXIMUM RATINGS

Ta=25°C

Parameter	Symbol	Rating	Units	Conditions
Absolute Maximum Ratings				
Supply Voltage	V _{CCMAX}	-0.4 ~ 16	V	
Reverse Bias	V _{revMAX}	-0.4 ~ 6	V	
Control pin Voltage	V _{contMAX}	-0.4 ~ 16	V	
Base Drive pin Voltage	V _{baseMAX}	-0.4 ~ 16	V	
Storage Temperature Range	T _{stg}	-55 ~ 150	°C	
Power Dissipation	P _D	500 when mounted on PCB	mW	* Internal Limited Tj=150°C
Operating Condition				
Operating Temperature Range	T _{OP}	-30 ~ 80	°C	
Operating Voltage Range	V _{OP}	1.8 ~ 14	V	
Short Circuit Current	Ishort	200	mA	

8. ELECTRICAL CHARACTERISTICS

Unless otherwise specified Vin=VoutTyp+1.0V ,Vcont=1.8V

Ta=25°C

Parameter	Symbol	Value			Units	Conditions
		Min	Typ	Max		
Output Voltage	Vout	± 2% or ± 60mV *1			V	Iout=5mA
Line Regulation	LinReg		1.0	5.0	mV	ΔVin=5V
Load Regulation	LoaReg		0.7	3.0	% Vout	Iout=5 ~ 100mA (Vout=1.5~2.0V)
			0.6	2.5	% Vout	Iout=5 ~ 100mA (Vout=2.1~5.0V)
Dropout Voltage	Vdrop		105	180	mV	Iout=50mA *2
			180	280	mV	Iout=100mA *2
Maximum Output Current	IoutMAX	120	150		mA	Vout 10% drop
Supply Current	Icc		50	80	μA	Vout ON state Iout=0mA
Standby Current	Istandby		0	0.1	μA	Vout OFF state Vin=10V
Base drive Current	Ibase	7	10		mA	*3
Control Terminal						
Control Current	Icont		0.9	3.0	μA	Vcont=1.8V Output ON state
Control Voltage	Vcont	1.8			V	Vout ON state
				0.8	V	Vout OFF state

*1 Refer to Table 1.

*2 For Vout 2.0V, no regulations.

*3 Make sure that this terminal is not connected to GND otherwise the IC may damaged with excessive current due to circuit structure.

I rank (-40~85) is separately provided.

Output voltage standard table ($\pm 2\%$ or $\pm 60\text{mV}$)

Table 1

Vout TYP (V)	Vout Min (V)	Vout MAX (V)	Vin (V)	Vout TYP (V)	Vout Min (V)	Vout MAX (V)	Vin (V)
1.3	1.240	1.360	2.3	3.2	3.136	3.264	4.2
1.4	1.340	1.460	2.4	3.3	3.234	3.366	4.3
1.5	1.440	1.560	2.5	3.4	3.232	3.468	4.4
1.6	1.540	1.660	2.6	3.5	3.430	3.570	4.5
1.7	1.640	1.760	2.7	3.6	3.528	3.672	4.6
1.8	1.740	1.860	2.8	3.7	3.626	3.774	4.7
1.9	1.840	1.960	2.9	3.8	3.724	3.876	4.8
2.0	1.940	2.060	3.0	3.9	3.822	3.978	4.9
2.1	2.040	2.160	3.1	4.0	3.920	4.080	5.0
2.2	2.140	2.260	3.2	4.1	4.018	4.182	5.1
2.3	2.240	2.360	3.3	4.2	4.116	4.284	5.2
2.4	2.340	2.460	3.4	4.3	4.214	4.386	5.3
2.5	2.440	2.560	3.5	4.4	4.312	4.488	5.4
2.6	2.540	2.660	3.6	4.5	4.410	4.590	5.5
2.7	2.640	2.760	3.7	4.6	4.508	4.692	5.6
2.8	2.740	2.860	3.8	4.7	4.606	4.794	5.7
2.9	2.840	2.960	3.9	4.8	4.704	4.896	5.8
3.0	2.940	3.060	4.0	4.9	4.802	4.998	5.9
3.1	3.038	3.162	4.1	5.0	4.900	5.100	6.0

9. TEST CIRCUIT

Standard circuit (Iout 100mA)

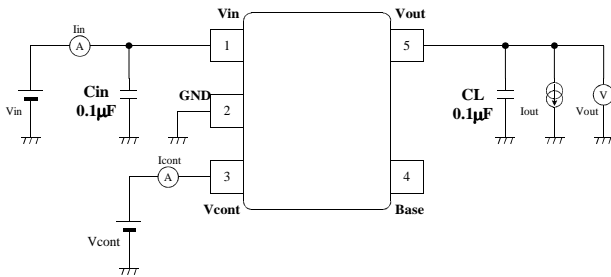

Applied circuit: When external PNPT_r is used

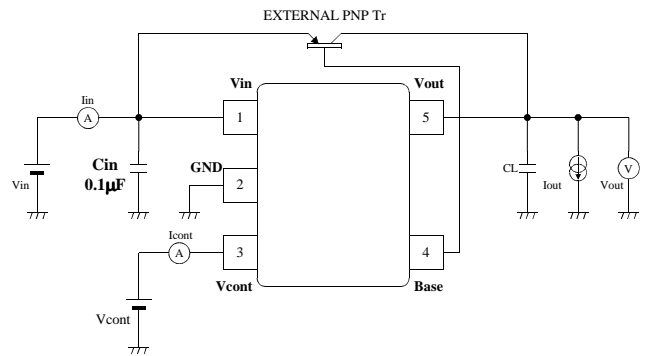

Input/Output capacitors (CL)

Linear regulators require input and output capacitors in order to maintain the regulator’s loop stability. The equivalent series resistance(ESR) of the output capacitor must be in the stable operation area. However, it is recommended to use as large a value of capacitance as is practical. The output noise and the ripple noise decrease as the capacitance value increases. The IC is never damaged by enlarging the capacitance.

ESR values vary widely between ceramic and tantalum capacitors, However, tantalum capacitors are assumed to provide more ESR damping resistance, which provides greater circuits stability. This implies that a higher level of circuit stability can be obtained by using tantalum capacitors when compared to ceramic capacitors with similar values. The IC provides stable operation with an output side capacitor CL of 0.1μF(Iout 2mA). If the capacitor is 0.1μF or more over the full range of temperature, either a ceramic capacitor or tantalum capacitor can be used without concerning the ESR.

A recommended value of the application is as follows.

Vout 1.3V、Iout 0mA
 CL 0.1μF(Tantalum)
 or CL 1.0μF(MLCC)

Vout 1.3V、Iout 2mA
 CL 0.1μF any Type

Vout 3.0V、Iout 0mA
 CL 0.1μF any Type

The input capacitor is necessary when the battery is discharged, the power supply impedance increases, or the line distance to the power supply is long. This capacitor might be necessary on each individual IC even if two or more regulator ICs are used. It is not possible to determine this indiscriminately. Please confirm the stability while mounted.

Generally, Multi layer ceramic capacitor (MLCC) has the temperature characteristic and the voltage characteristic. Please select parts in consideration of the voltage and the temperature used.

Stability area graph (Vout=1.3~5.0V)

Condition : Vin=VoutTyp+1V Cin=0.1μF(MLCC)

CL=0.022μF(MLCC)

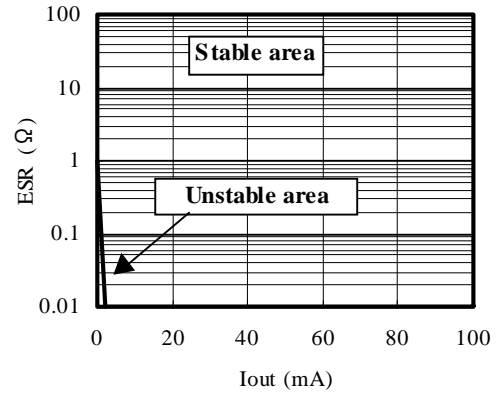

CL=1.0μF(MLCC)

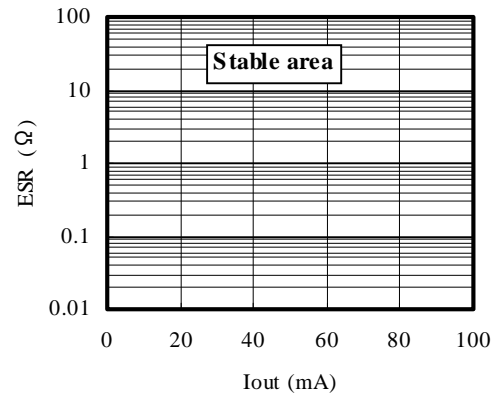

CL=0.1μF(Tantalum)

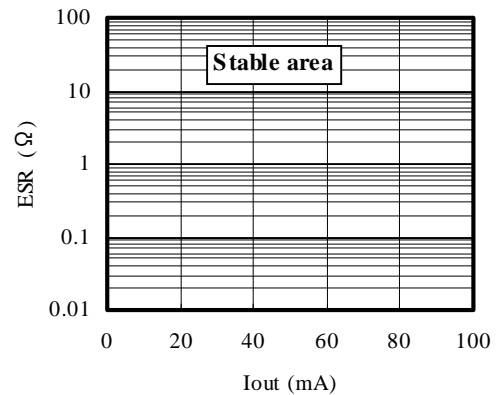

10. TYPICAL CHARACTERISTICS

10-1 DC CHARACTERISTICS (TK71430S)

Unless otherwise specified $V_{in}=V_{outTyp}+1V, V_{cont}=1.8V, C_{in}=0.1\mu F, C_L=0.1\mu F, T_a=25^{\circ}C$

■ Vin vs Iin

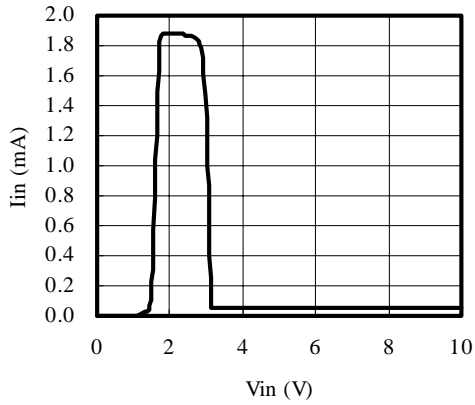

■ Line Regulation

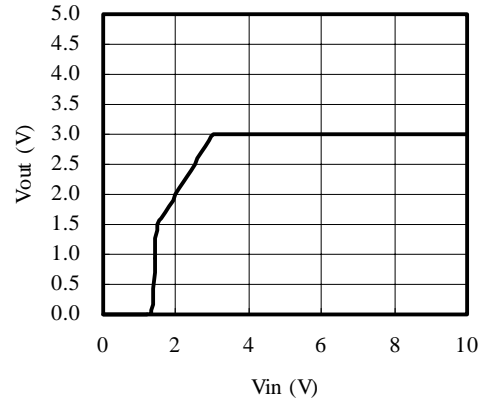

■ Load Regulation

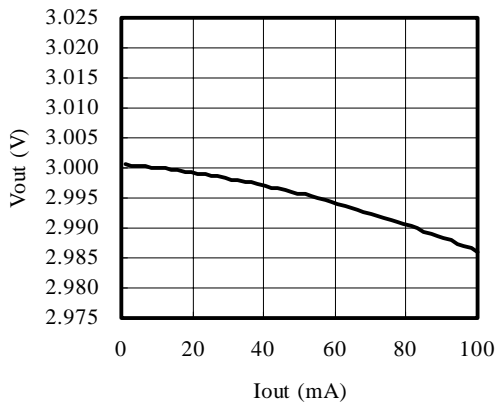

■ Dropout Voltage

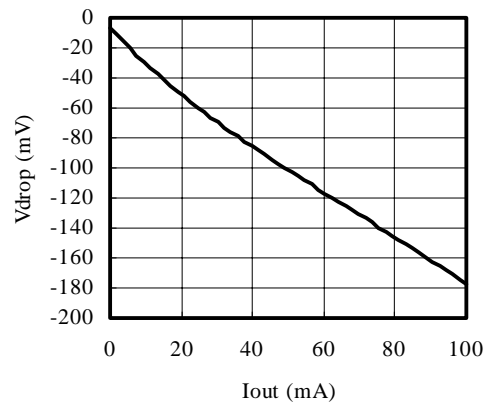

■ Vin vs Vout Regulation Point

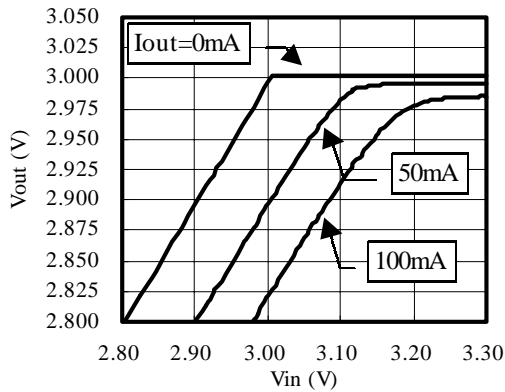

■ Short circuit current

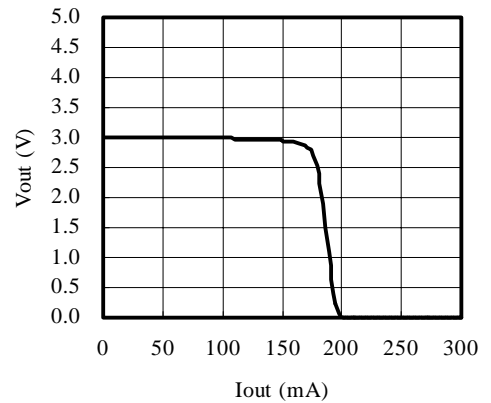

■ Reverse Bias Current

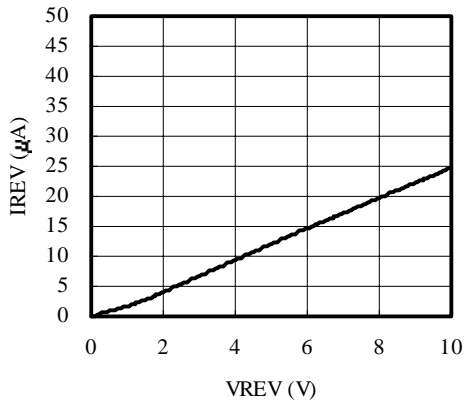

■ Iin (Off state)

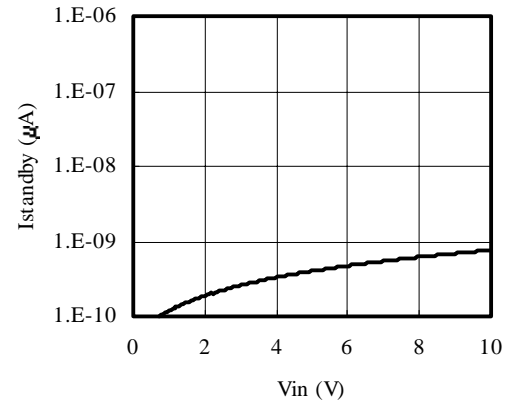

■ Vcont vs Icont

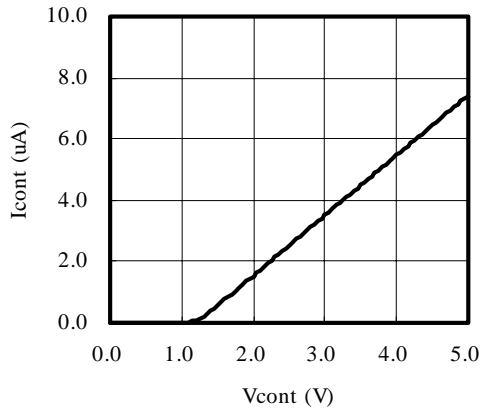

■ GND PIN Current

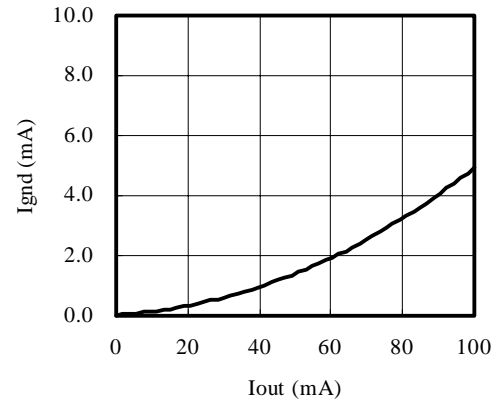

■

■

Temperature characteristic

■ Quiescent current

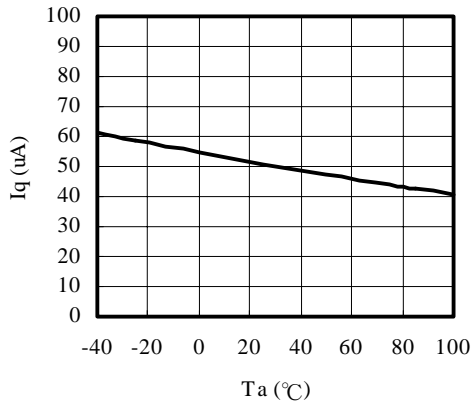

■ V_{out}

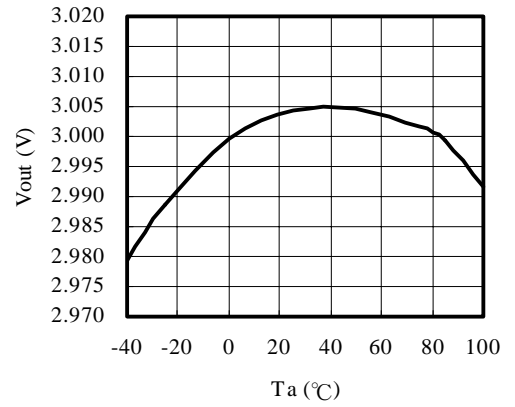

■ Dropout Voltage

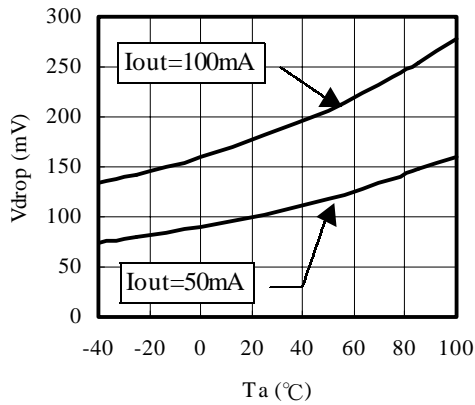

■ $I_{out MAX}$

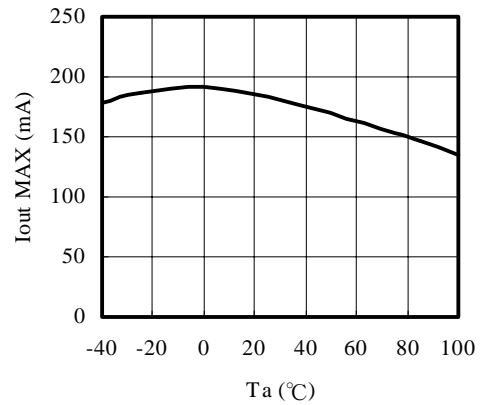

■ ON/Off Point

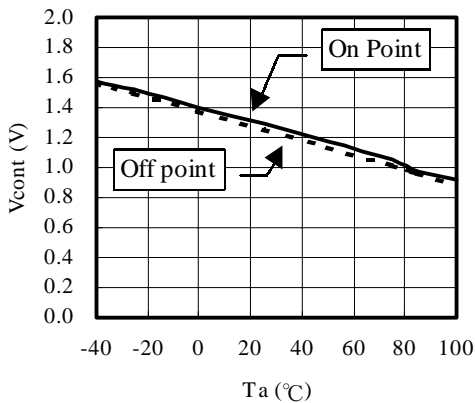

■ Base drive current

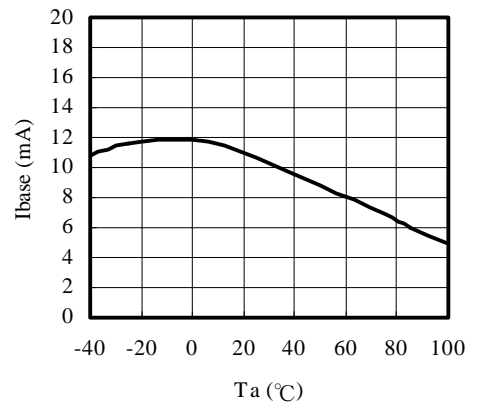

10-2 AC CHARACTERISTICS(TK71430S)

Ripple Rejection

Vin=4.5V Vripple=200mVp-p Cin=None Iout=10mA f=100~1M(Hz) LOG Scale

■ CL=0.47μF(MLCC)

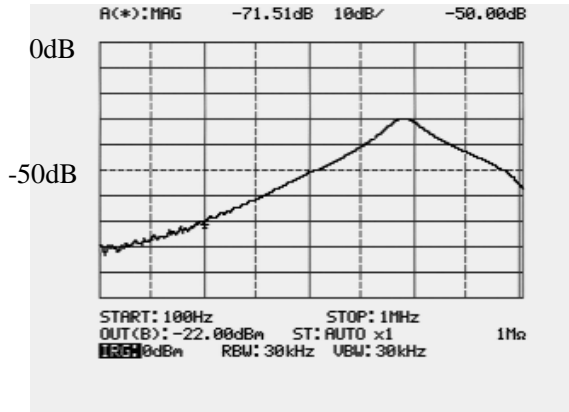

■ CL=1.0μF(MLCC)

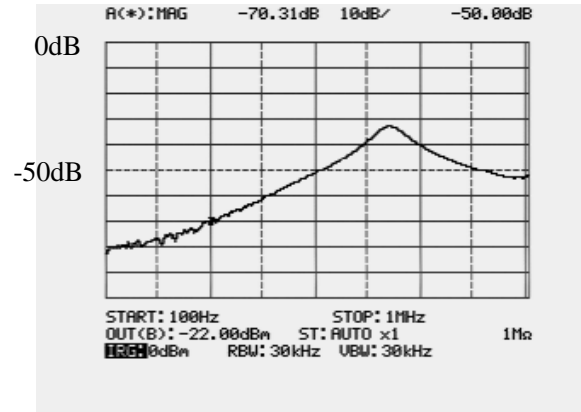

■ CL=1.0μF(Tantalum)



■ CL=10μF(Tantalum)



■

■ Measurement circuit chart

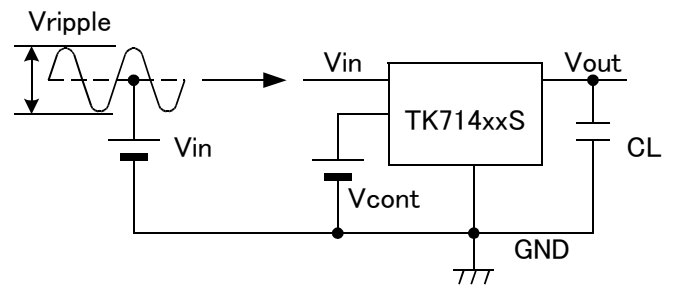

Output noise characteristic (TK71430S)

■ CL=0.1μF (MLCC)

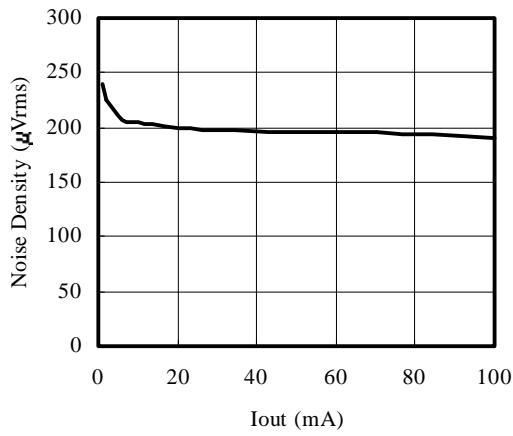

■ CL=0.1μF (Tantalum)

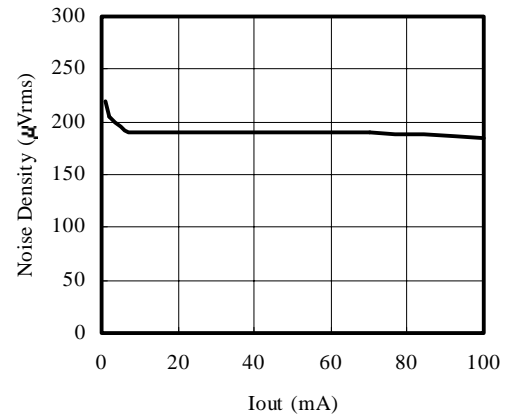

■ CL=1.0μF (MLCC)

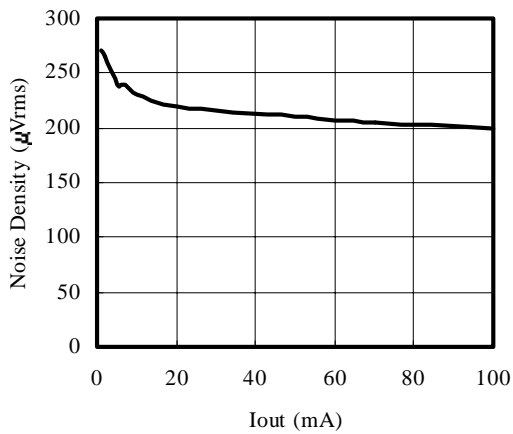

■ CL=1.0μF (Tantalum)

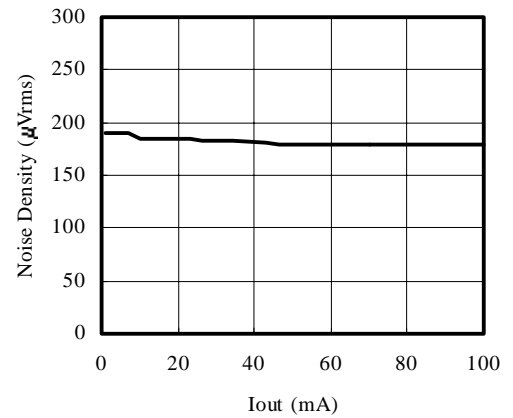

■ CL=10μF (MLCC)

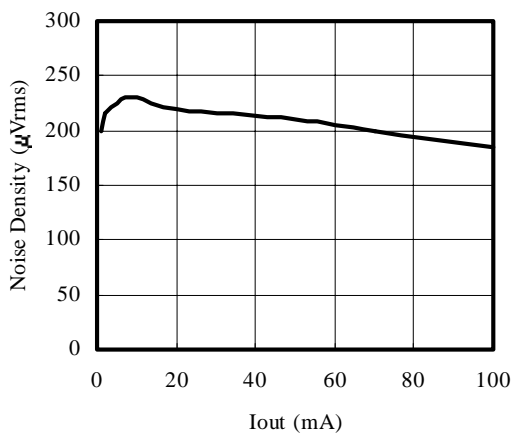

■ CL=10μF (Tantalum)

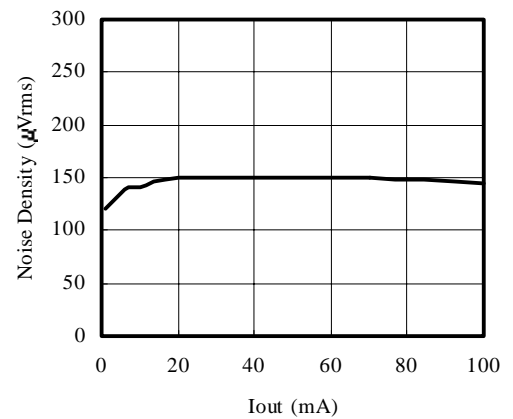

ON/OFF Transient

Vin=4.0V Iout=5mA Cin=0.1μF

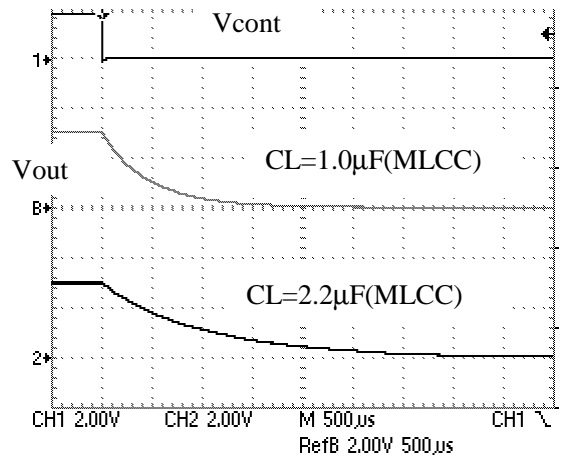
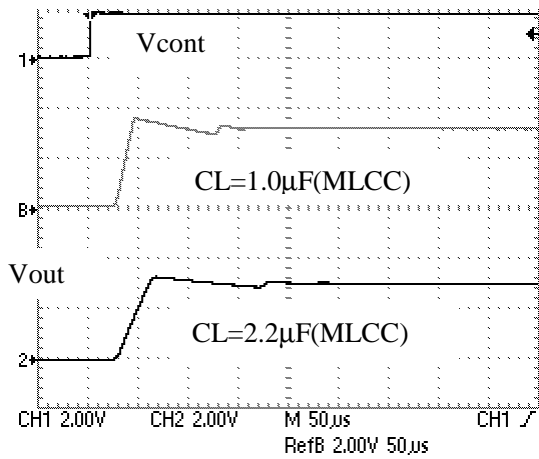
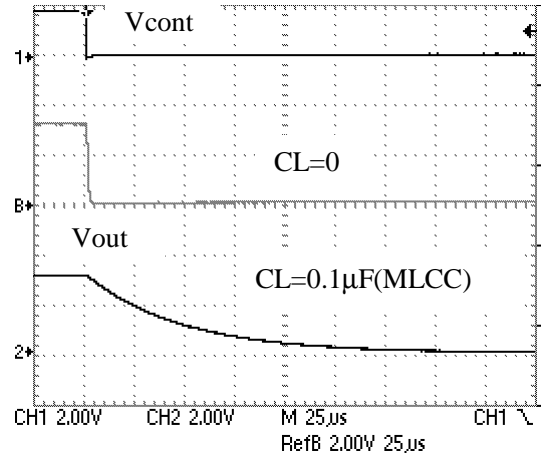
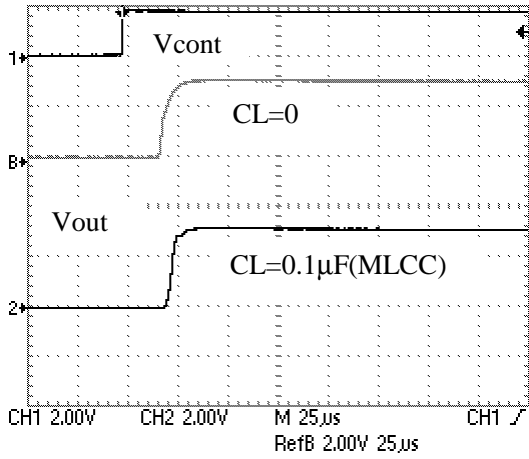

Line Transient

Vcont=1.8V Iout=5mA Cin=0.1μF

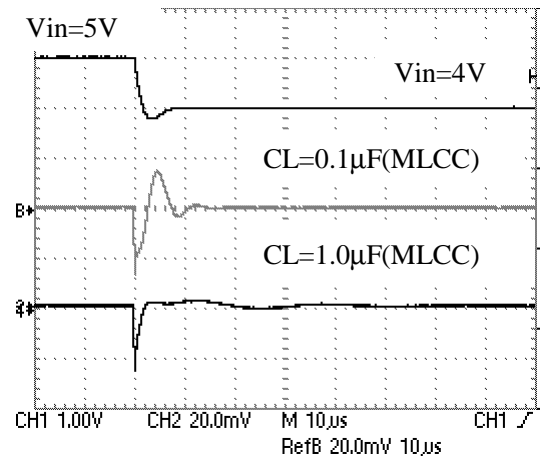
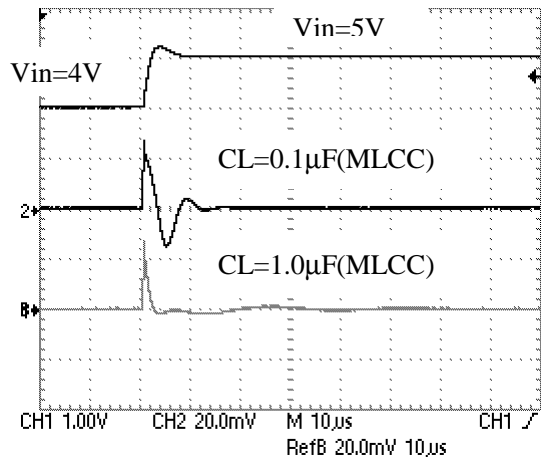

Load Transient

Vin=4.0V Iout=5mA Cin=0.1μF

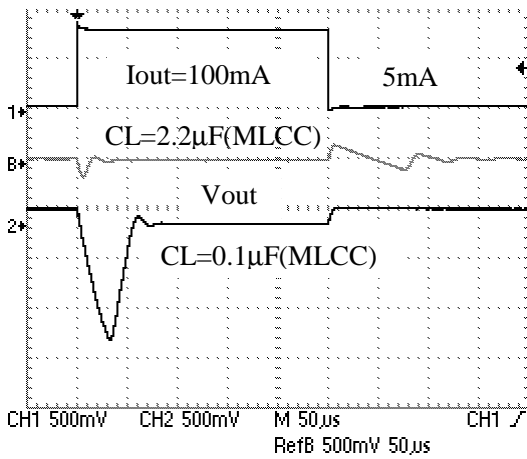
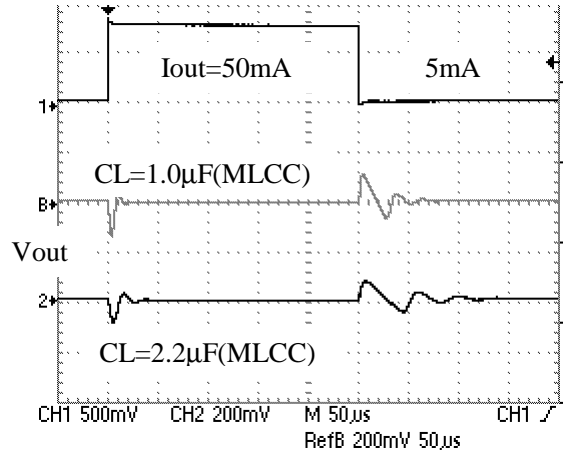
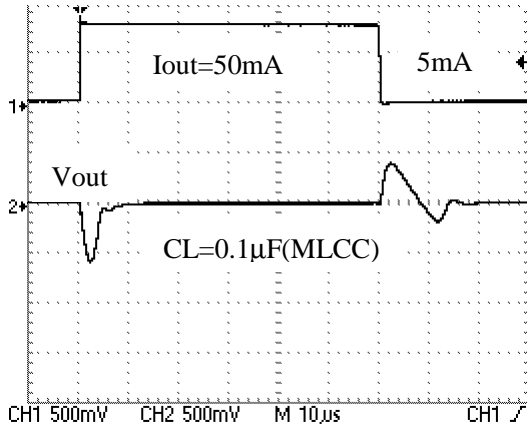

The load transient (no load) can be greatly improved by delivering a little load current to ground. Increase the load side capacitor when the load change is fast or when there is a large current change.

11. PIN DESCRIPTION

Pin No.	Pin Description	Internal Equivalent Circuit	Description
1	Vin	-	Input terminal
2	GND	-	GND terminal
3	Vcont		ON/OFF control terminal The pull down resistance is not built in.
4	BASE		Base terminal for external PNP transistor
5	Vout		Output terminal $V_{out} = V_{ref} \times \frac{R1 + R2}{R1}$ *Make sure that this terminal is not connected to GND otherwise the IC may be damaged with excessive current due to circuit structure.

12. APPLICATIONS INFORMATION

12-1. Definition of term

Output voltage (Vout)

The output voltage is specified with $V_{in} = (V_{outTYP} + 1V)$ and $I_{out} = 5mA$.

Maximum output current (Iout MAX)

The rated output current is specified under the condition where the output voltage drops 0.9V times the value specified with $I_{out} = 5mA$. The input voltage is set to $V_{outTYP} + 1V$ and the current is pulsed to minimize temperature effect.

Dropout Voltage (Vdrop)

The dropout voltage is the difference between the input voltage and the output voltage at which point the regulator starts to fall out of regulation. Below this value, the output voltage will fall as the input voltage is reduced. It is dependent upon the load current and the junction temperature.

Line Regulation (LinReg)

Line regulation is the ability of the regulator to maintain a constant output voltage as the input voltage changes. The line regulation is specified as the input voltage is changed from $V_{in} = V_{outTYP} + 1V$ to $V_{in} = V_{outTYP} + 6V$. It is a pulse measurement to minimize temperature effect.

Load Regulation (LoaReg)

Load regulation is the ability of the regulator to maintain a constant output voltage as the load current changes. It is a pulsed measurement to minimize temperature effects with the input voltage set to $V_{in} = V_{outTYP} + 1V$. The load regulation is specified output current step conditions of 5mA to 100mA.

Ripple Rejection (R.R)

Ripple rejection is the ability of the regulator to attenuate the ripple content of the input voltage at the output. It is specified with $200mV_{RMS}$, 1kHz superimposed on the input voltage, where $V_{in} = V_{out} + 1.5V$. Ripple rejection is the ratio of the ripple content of the output vs. input and is expressed in dB

Standby current(Istandby)

Standby current is the current which flows into the regulator when the output is turned off by the control function($V_{cont}=0V$). It is measured with $V_{in}=10V$.

Over Current Sensor

The over current sensor protects the device when there is excessive output current. It also protects the device if the output is accidentally connected to ground. (When external transistor is used, the protection operates at 10mA at the base terminal)

Thermal Sensor

The thermal sensor protects the device in case the junction temperature exceeds the safe value($T_j=150$). This temperature rise can be caused by external heat, excessive power dissipation caused by large input to output voltage drops, or excessive output current. The regulator will shut off when the temperature exceeds the safe value. As the junction temperatures decrease, the regulator will begin to operate again. Under sustained fault conditions, the regulator output will oscillate as the device turns off then resets. Damage may occur to the device under extreme fault.

Please reduce the loss of the regulator when this protection operate, by reducing the input voltage or make better heat efficiency.

Reverse Voltage Protection

Reverse voltage protection prevents damage due to the output voltage being higher than the input voltage. This fault condition can occur when the output capacitor remains charged and the input is reduced to zero, or when an external voltage higher than the input voltage is applied to the output side. The maximum reverse bias voltage is 6V.

ESD

MM:200pF 0Ω 200V or more
 HBM:100pF 1.5kΩ 2000V or more

12-2.External transistor use

Connection example.

The base drive current is TYP10mA($T_a=25$). Please select the suitable external transistor matched to the output current.

The built in PNPT_r does not operate when external transistor is connected. Moreover, be careful for the output short-circuit. An external transistor might be damaged.

Selection of CL

Please choose CL according to the characteristic of the external transistor. We recommend using twice the value of the capacitor of which the oscillation stops. (When stabilized with 1μF, 2.2μF is recommended)

Please follow below if you cannot keep the stability of the output.

- : Add R_Base
- : Add series resistance (Rs) to CL, or, change CL to the electrolytic capacitor, etc.(When using MLCC)

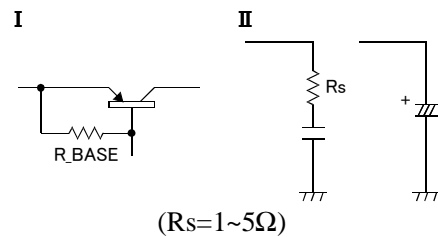

Attention Make sure that this terminal is not connected to GND or the IC may damaged with excessive current due to circuit structure.

Please refer to next page for the data when using an external transistor.

Example of characteristic when using external transistor

■ Load Regulation (2SB1301)

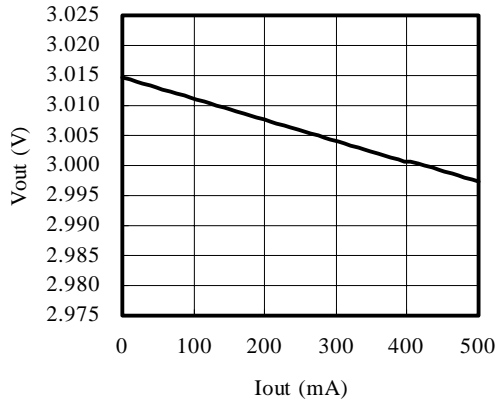

■ Load Regulation (2SA1203)

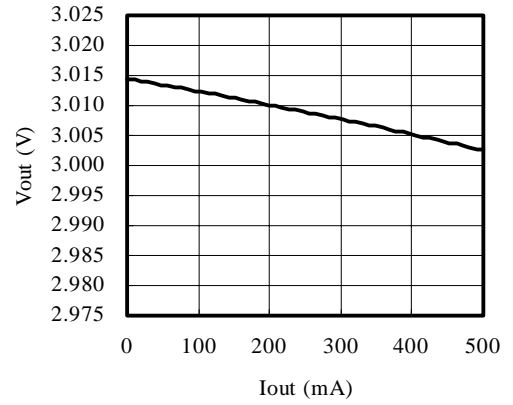

■ Dropout Voltage (2SB1301)

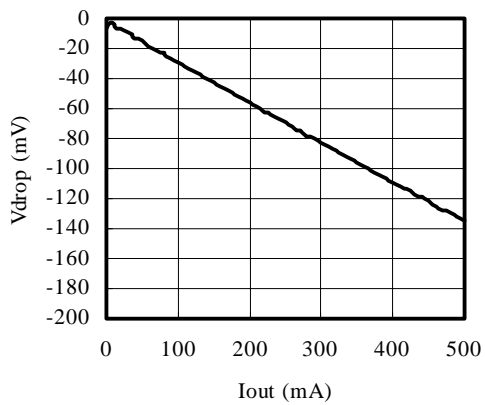

■ Dropout Voltage (2SA1203)

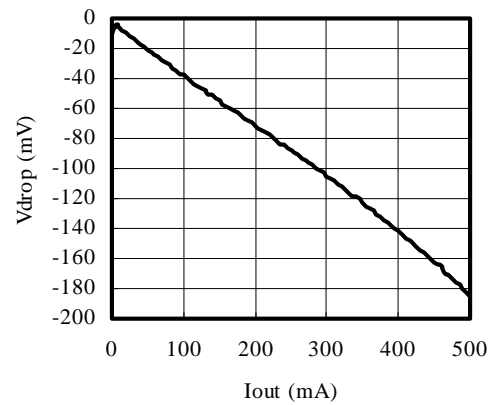

12-3.Layout

Board Layout without external transistor

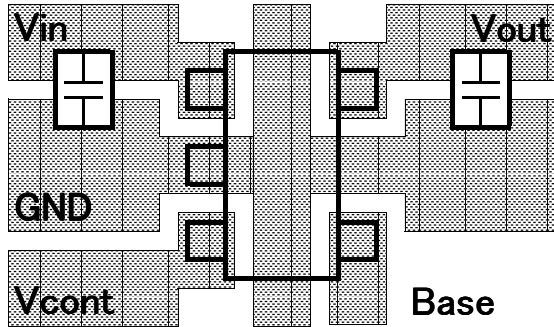

PCB Material:Glass epoxy (t=0.8mm)

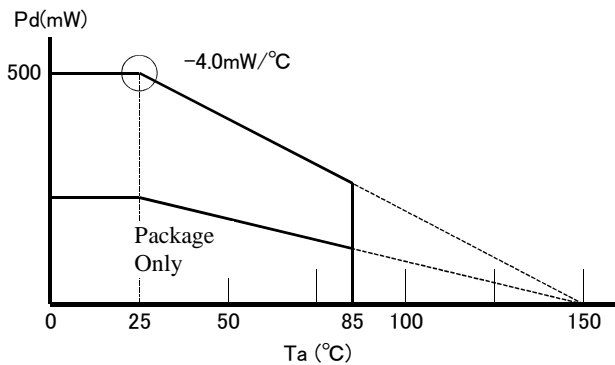

Please do derating with 4mW/ at Pd=500mW and 25 or more. Thermal resistance is (ja=250 /W)

The package loss is limited at the temperature that the internal temperature sensor works (about 150°C). Therefore, the package loss is assumed to be an internal limitation. There is no heat radiation characteristic of the package unit assumed because of the small size. Heat is carried away by the device being mounted on the PCB. This value changes by the material and the copper pattern etc. of the PCB. The losses are approximately 500mW. Enduring these losses becomes possible in a lot of applications operating at 25°C.

The overheating protection circuit operates when there are a lot of losses with the regulator (When outside temperature is high or heat radiation is bad). The output current cannot be pulled enough and the output voltage will drop when the protection circuit operates. When the junction temperature reaches 150 , the IC is shut down. However, operation begins at once when the IC stops operation and the temperature of the chip decreases.

How to determine the thermal resistance when mounted on PCB

The thermal resistance when mounted is expressed as follows:

$$T_j = j_a \times P_d + T_a$$

Tj of IC is set around 150 . Pd is the value when the thermal sensor is activated.

If the ambient temperature is 25 , then:

$$150 = j_a \times P_d + 25$$

$$j_a \times P_d = 125$$

$$j_a = 125 / P_d \text{ (/mW)}$$

Pd is easily calculated.

A simple way to determine Pd is to calculate Vin x Iin when the output side is shorted. Input current gradually falls as temperature rises. You should use the value when thermal equilibrium is reached. In many cases, heat radiation is good, and Pd has 500mW or more.

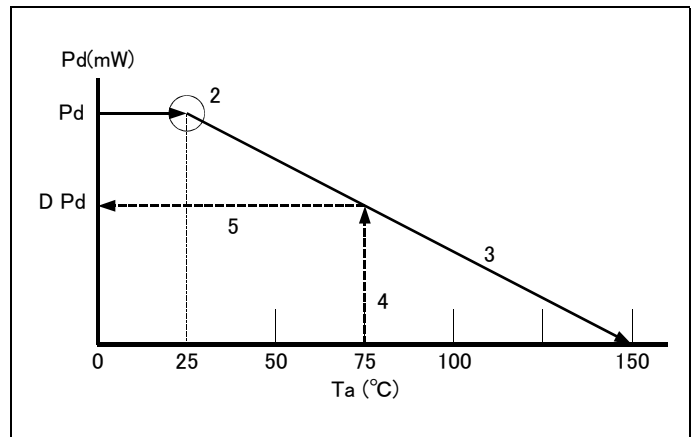

Procedure (When mounted on PCB).

1. Find Pd (Vin x Iin when the output side is short-circuited).
2. Plot Pd against 25 .
3. Connect Pd to the point corresponding to the 150 with a straight line.
4. In design, take a vertical line from the maximum operating temperature (e.g., 75) to the derating curve.
5. Read off the value of Pd against the point at which the vertical line intersects the derating curve. This is taken as the maximum power dissipation DPd.
6. $DP_d \div (V_{inmax} - V_{out}) = I_{out}$ (at 75)

The maximum output current at the highest operating temperature will be **Iout DPd ÷ (Vinmax-Vout)**.

Please use the device at low temperature with better radiation. The lower temperature provides better quality.

13.Outline : PCB : Stamps

SOT23-5

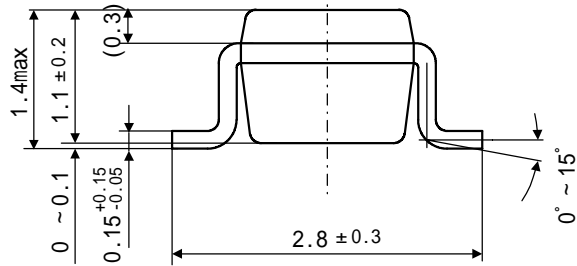
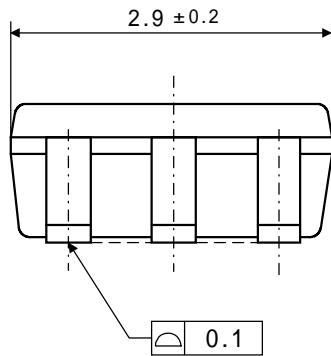
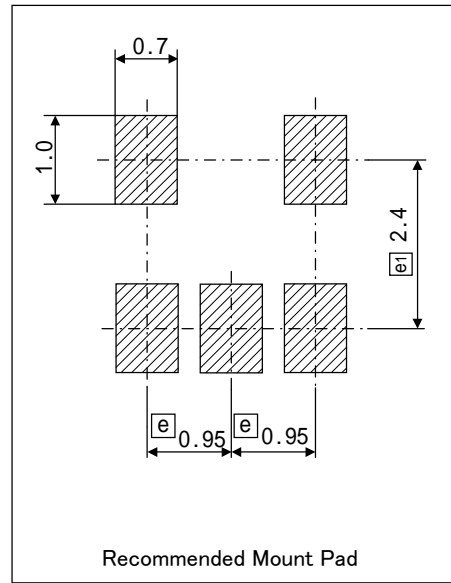
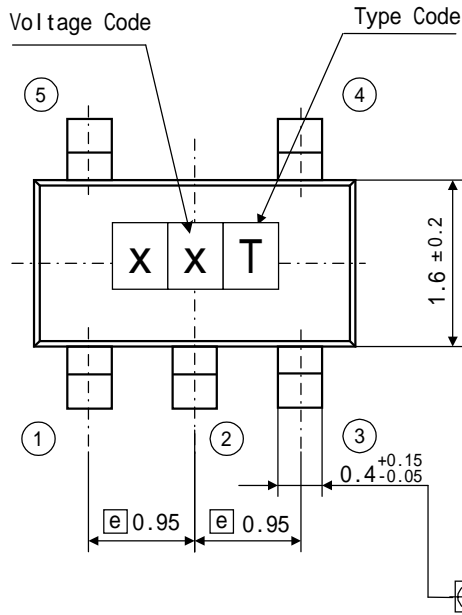

Unit : mm

General tolerance : ± 0.2

- Molded Resin with Body : Epoxy Resin
- Treatment : Solder Plating (5 ~ 15µm)
- Country of origin : Japan
- Lead Frame : Copper Alloy
- Marking Method : Laser
- Weight : 0.016g

Vout (V)	Voltage Code	Vout (V)	Voltage Code	Vout (V)	Voltage Code	Vout (V)	Voltage Code
1.5	15	2.4	24	3.3	33	4.2	42
1.6	16	2.5	25	3.4	34	4.3	43
1.7	17	2.6	26	3.5	35	4.4	44
1.8	18	2.7	27	3.6	36	4.5	45
1.9	19	2.8	28	3.7	37	4.6	46
2.0	20	2.9	29	3.8	38	4.7	47
2.1	21	3.0	30	3.9	39	4.8	48
2.2	22	3.1	31	4.0	40	4.9	49
2.3	23	3.2	32	4.1	41	5.0	50

14. NOTES

- Please be sure that you carefully discuss your planned purchase with our office if you intend to use the products in this application manual under conditions where particularly extreme standards of reliability are required, or if you intend to use products for applications other than those listed in this application manual.
 - Power drive products for automobile, ship or aircraft transport systems; steering and navigation systems, emergency signal communications systems, and any system other than those mentioned above which include electronic sensors, measuring, or display devices, and which could cause major damage to life, limb or property if misused or failure to function.
 - Medical devices for measuring blood pressure, pulse, etc., treatment units such as coronary pacemakers and heat treatment units, and devices such as artificial organs and artificial limb systems which augment physiological functions.
 - Electrical instruments, equipment or systems used in disaster or crime prevention.

- Semiconductors, by nature, may fail or malfunction in spite of our devotion to improve product quality and reliability. We urge you to take every possible precaution against physical injuries, fire or other damages which may cause failure of our semiconductor products by taking appropriate measures, including a reasonable safety margin, malfunction preventive practices and fire-proofing when designing your products.

- This application manual is effective from DEC 2001. Note that the contents are subject to change or discontinuation without notice. When placing orders, please confirm specifications and delivery condition in writing.

- TOKO is not responsible for any problems nor for any infringement of third party patents or any other intellectual property rights that may arise from the use or method of use of the products listed in this application manual. Moreover, this application manual does not signify that TOKO agrees implicitly or explicitly to license any patent rights or other intellectual property rights which it holds.

- None of ozone depleting substances(ODS) under the Montreal Protocol is used in manufacturing process of us.

15. OFFICES

- If you need more information on this product and other TOKO products, please contact us.
- TOKO Inc. Headquarters
 1-17, Higashi-yukigaya 2-chome, Ohta-ku, Tokyo, 145-8585, Japan
 TEL: +81.3.3727.1161
 FAX: +81.3.3727.1176 or +81.3.3727.1169
 Web site: <http://www.toko.co.jp/>

 - TOKO America
 Web site: <http://www.toko.com/>

 - TOKO Europe
 Web site: <http://www.tokoeurope.com/>

 - TOKO Hong Kong
 Web site: <http://www.toko.com.hk/>

 - TOKO Taiwan
 Web site: <http://www.toko.com.tw/>

 - TOKO Singapore
 Web site: <http://www.toko.com.sg/>

 - TOKO Seoul
 Web site: <http://www.toko.co.kr/>

 - TOKO Manila
 Web site: <http://www.toko.com.ph/>

 - TOKO Brazil
 Web site: <http://www.toko.com.br/>



TO BUILD THE QUALITY RELIED BY COSTOMERS
Semiconductor Division

YOUR DISTRIBUTOR