

General Description

The AAT3684 BatteryManager is an integrated single cell lithium-ion/polymer battery charger IC, designed to operate from a DC power source or USB port up to an input voltage of 6.5V. It requires just one external component.

The AAT3684 precisely regulates battery charge voltage and current for 4.2V (4.375V option) lithium-ion/polymer battery cells. When charged from an AC adapter or USB port, the battery charging current can be set by an external resistor up to 500mA.

Battery charge state is continuously monitored for fault conditions. In the event of an over-voltage, short-circuit, or over-temperature failure, the device will automatically shut down, thus protecting the charging device, control system, and the battery under charge. A status monitor output pin is provided to indicate the battery charge status by directly driving an external LED.

The AAT3684 is available in a Pb-free, thermally enhanced, space-saving 10-pin 2.2x2.2mm STDFN package and is specified for operation over the -40°C to +85°C temperature range.

Features

- USB or AC Adapter System Power Charger
 - Programmable from 15mA to 500mA
- 4.0V ~ 6.5V Input Voltage Range
- High Level of Integration with Internal:
 - Charging Device
 - Reverse Blocking Diode
- Automatic Current Sensing
- Automatic Recharge Sequencing
- Full Battery Charge Auto Turn Off/Sleep Mode/Charge Termination
- Shutdown Current <1µA
- Automatic Trickle Charge for Battery Pre-Conditioning (AAT3684-1 is No Trickle Charge Option)
- Over-Voltage and Emergency Thermal Protection
- Power On Reset and Soft Start
- LED Status Pin
- STDFN2.2x2.2-10 Package

Applications

- Bluetooth® Headsets
- DECT Headsets
- Digital Still Cameras
- MP3, Portable Music, and Portable Media Players
- Personal Data Assistants (PDAs)
- Wrist Watches
- Other Lithium-Ion/Polymer Battery-Powered Devices

Typical Application

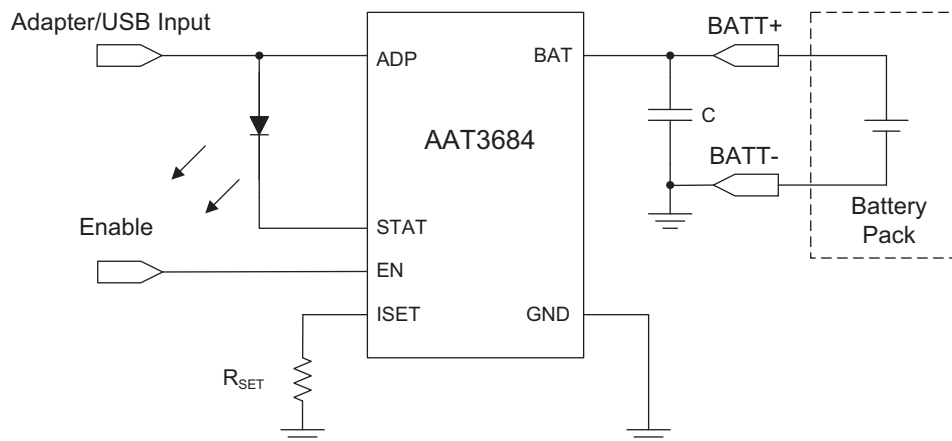

Pin Description

Pin #	Symbol	Type	Function
1, 2, 3, 7	N/C		Not connected.
4	STAT	Out	Open drain status pin.
5	GND	Power	Ground connection.
6	ADP	Power In	Input from USB/adaptor charger.
8	BAT	In/Out	Battery charging and sensing.
9	ISET	In/Out	Connect resistor here to set the charge current.
10	EN	In	Enable pin. Logic high enables the IC (internally pulled down).
EP			Exposed paddle (bottom): connect to ground as closely as possible to the device.

Pin Configuration

STDFN2.2x2.2-10
(Top View)

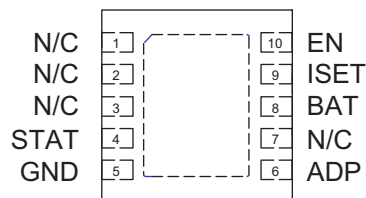

AAT3684 Feature Options

Product	Trickle Charge
AAT3684	Yes
AAT3684-1	No

Absolute Maximum Ratings¹

Symbol	Description	Value	Units
V_P	ADP Continuous	-0.3 to 7.5	V
V_N	BAT, STAT, I_{SET} , EN	-0.3 to $V_P + 0.3$	V
T_J	Operating Junction Temperature Range	-40 to 150	°C
T_{LEAD}	Maximum Soldering Temperature (at Leads)	300	°C

Thermal Information²

Symbol	Description	Value	Units
P_D	Maximum Power Dissipation	2	W
θ_{JA}	Maximum Thermal Resistance	50	°C/W

1. Stresses above those listed in Absolute Maximum Ratings may cause permanent damage to the device. Functional operation at conditions other than the operating conditions specified is not implied. Only one Absolute Maximum Rating should be applied at any one time.

2. Mounted on an FR4 board.

Electrical Characteristics

$V_{ADP} = 5V$, $T_A = -40^{\circ}C$ to $+85^{\circ}C$, unless otherwise noted. Typical values are $T_A = 25^{\circ}C$.

Symbol	Description	Conditions	Min	Typ	Max	Units
Operation						
V_{ADP}	Adapter Voltage Range		4.0		6.5	V
V_{UVLO}	Under-Voltage Lockout (UVLO)	Rising Edge	3		4	V
	UVLO Hysteresis			150		mV
I_{OP}	Operating Current	Charge Current = 200mA		0.5	1	mA
$I_{SHUTDOWN}$	Shutdown Current	$V_{BAT} = 4.25V$, EN = GND		0.3	1	μA
$I_{LEAKAGE}$	Reverse Leakage Current from BAT Pin	$V_{BAT} = 4V$, ADP Pin Open		0.4	2	μA
Voltage Regulation						
V_{BAT_EOC}	End of Charge Accuracy		4.158	4.20	4.242	V
$\Delta V_{CH}/V_{CH}$	Output Charge Voltage Tolerance	$T_A = 25^{\circ}C$		0.5		%
V_{MIN}	Preconditioning Voltage Threshold	AAT3684 Only	2.85	3.0	3.15	V
V_{RCH}	Battery Recharge Voltage Threshold	Measured from V_{BAT_EOC}		-0.1		V
Current Regulation						
I_{CH}	Charge Current Programmable Range		15		500	mA
$\Delta I_{CH}/I_{CH}$	Charge Current Regulation Tolerance			10		%
V_{SET}	ISET Pin Voltage			2		V
K_{I_A}	Current Set Factor: I_{CH}/I_{SET}			800		
Charging Devices						
$R_{DS(ON)}$	Charging Transistor On Resistance	$V_{IN} = 5.5V$		0.9	1.1	Ω
Logic Control/Protection						
$V_{EN(H)}$	Input High Threshold		1.6			V
$V_{EN(L)}$	Input Low Threshold				0.4	V
V_{STAT}	Output Low Voltage	STAT Pin Sinks 4mA			0.4	V
I_{STAT}	STAT Pin Current Sink Capability				8	mA
V_{OVP}	Over-Voltage Protection Threshold			4.4		V
I_{TR}/I_{CH}	Pre-Charge Current	$I_{CH} = 100mA$; AAT3684 Only		10		%
I_{TERM}/I_{CH}	Charge Termination Threshold Current			10		%

Typical Characteristics

Constant Charging Current vs. Set Resistor Values

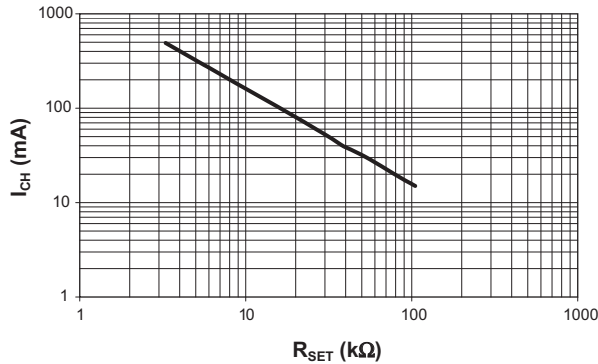

Charging Current vs. Battery Voltage (AAT3684 only)

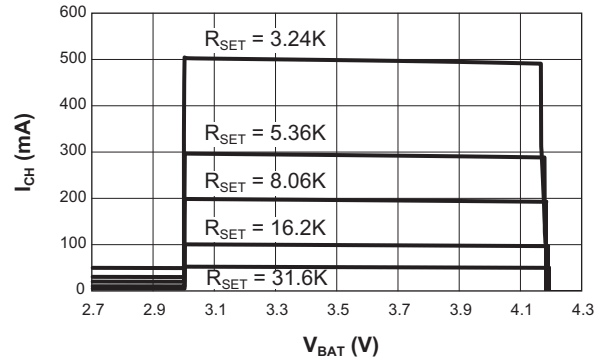

Charging Current vs. Battery Voltage (AAT3684-1 only)

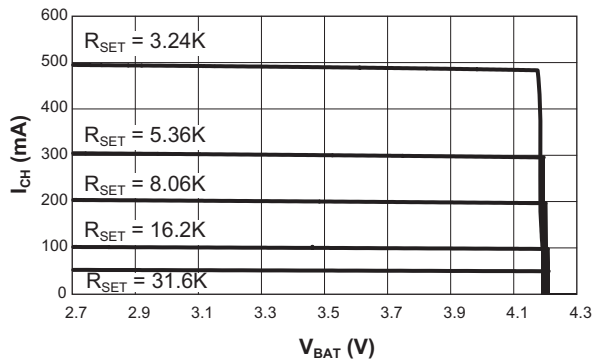

End of Charge Battery Voltage vs. Supply Voltage

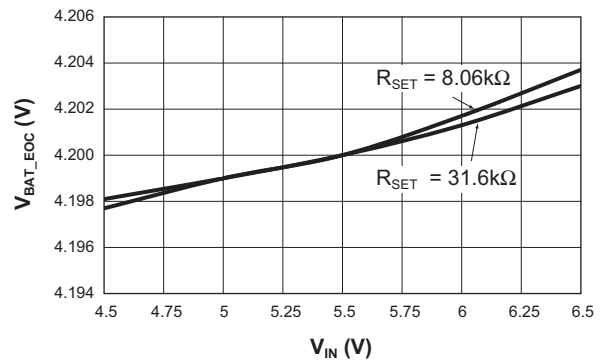

End of Charge Voltage Regulation vs. Temperature ($R_{SET} = 8.06k\Omega$)

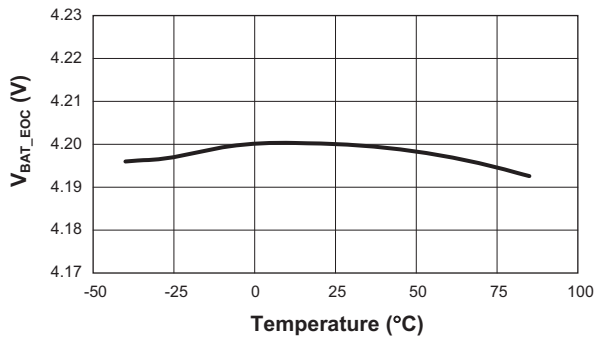

Constant Charging Current vs. Temperature ($R_{SET} = 8.06k\Omega$)

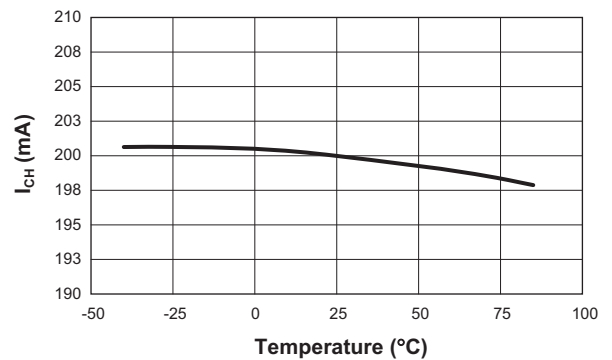

Typical Characteristics

Operating Supply Current vs. Set Resistor

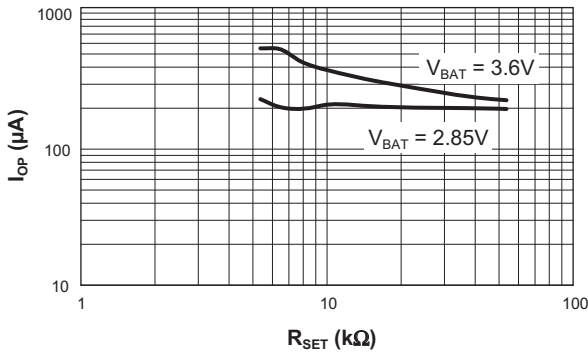

Operating Current vs. Temperature
(RSET = 8.06kΩ)

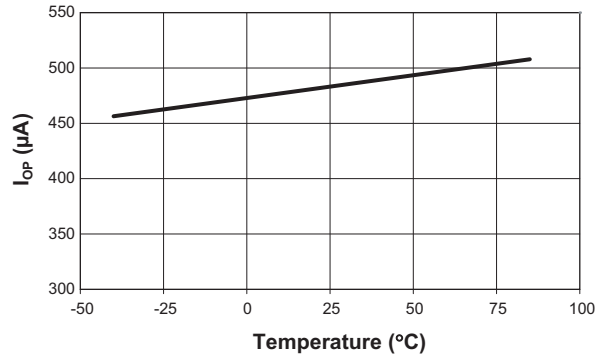

Preconditioning Threshold Voltage vs. Temperature
(RSET = 8.06kΩ; AAT3684 Only)

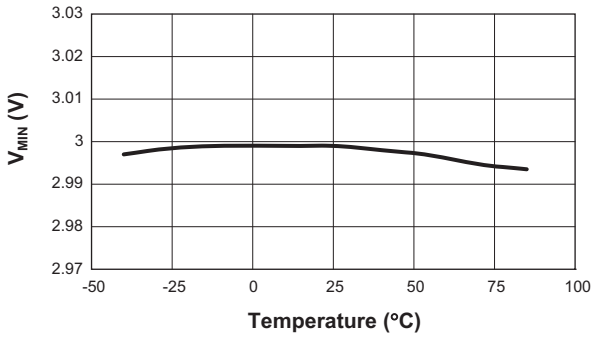

Preconditioning Charge Current vs. Temperature
(RSET = 8.06kΩ; AAT3684 Only)

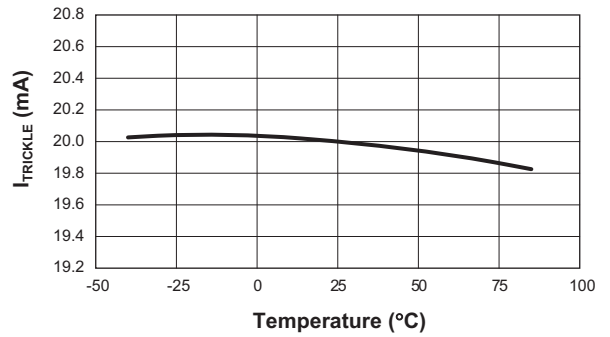

Preconditioning Charge Current vs. Supply Voltage
(AAT3684 Only)

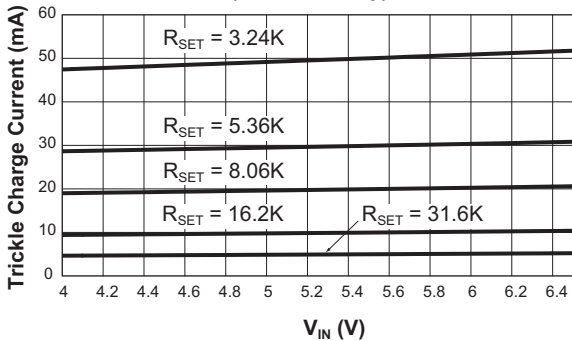

Recharging Threshold Voltage vs. Temperature
(RSET = 8.06kΩ)

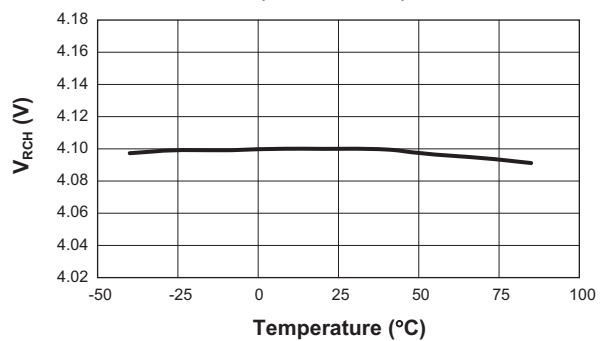

Typical Characteristics

Sleep Mode Current vs. Supply Voltage
($R_{SET} = 8.06k\Omega$)

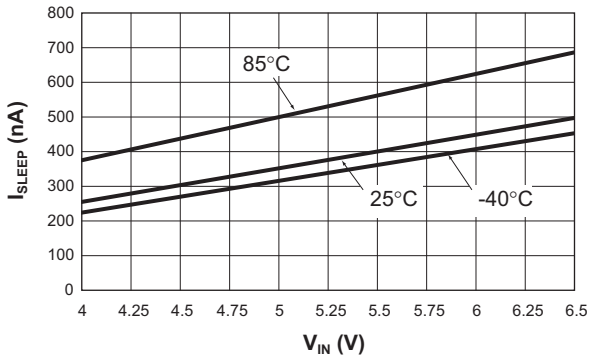

V_{IH_ENABLE} vs. Supply Voltage
($R_{SET} = 8.06k\Omega$)

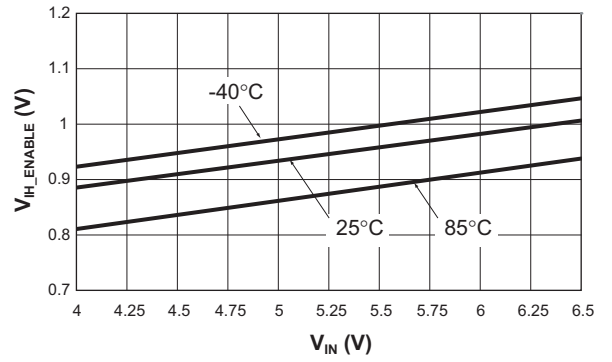

V_{IL_ENABLE} vs. Supply Voltage
($R_{SET} = 8.06k\Omega$)

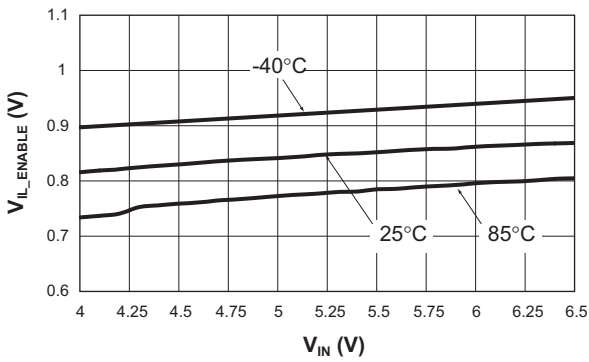

Functional Block Diagram

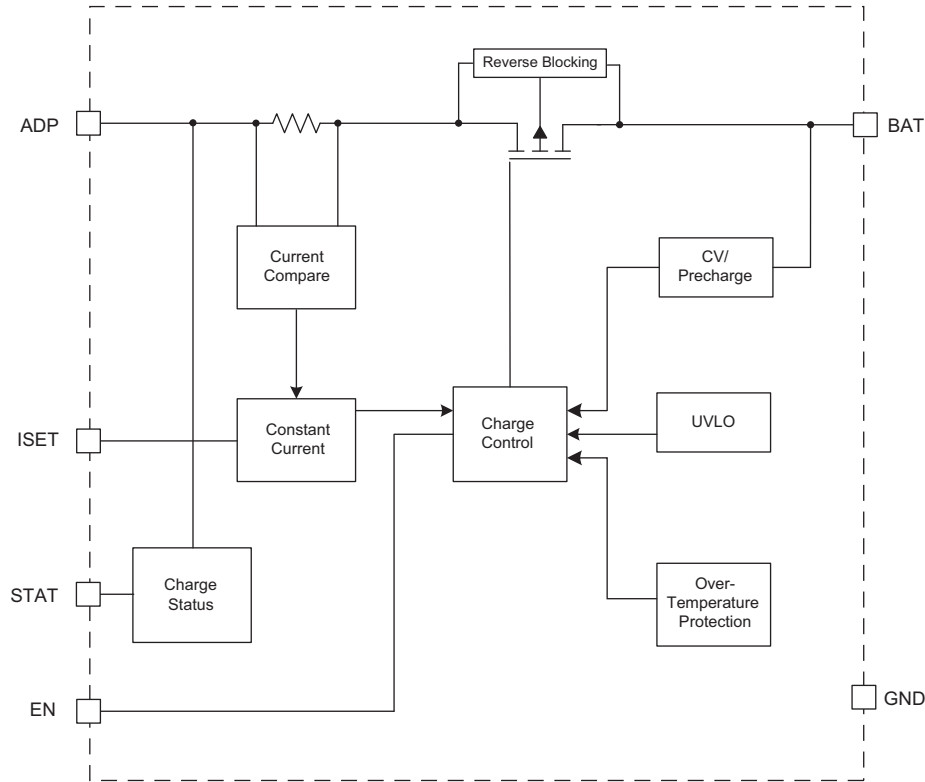

Functional Description

The AAT3684 is a high performance battery charger designed to charge single cell lithium-ion/polymer batteries with up to 500mA of current from an external power source. It is a stand-alone charging solution, with just one external component required for complete functionality. The AAT3684 precisely regulates battery charge voltage and current for 4.2V lithium-ion/polymer battery cells.

The adapter/USB charge input constant current level can be programmed up to 500mA for rapid charging applications. The AAT3684 is rated for operation from -40°C to +85°C. In the event of operating ambient temperatures exceeding the power dissipation abilities of the device package for a given constant current charge level, the charge control will enter into thermal limit.

A status monitor output pin is provided to indicate the battery charge state by directly driving one external LED.

Battery temperature and charge state are fully monitored for fault conditions. In the event of an over-voltage or over-temperature failure, the device will automatically shut down, protecting the charging device, control system, and the battery under charge.

Charging Operation

The AAT3684 has four basic modes for the battery charge cycle: pre-conditioning/trickle charge; constant current/fast charge; constant voltage; and end of charge. (See Figure 1.) (AAT3684-1 does not have trickle charge.)

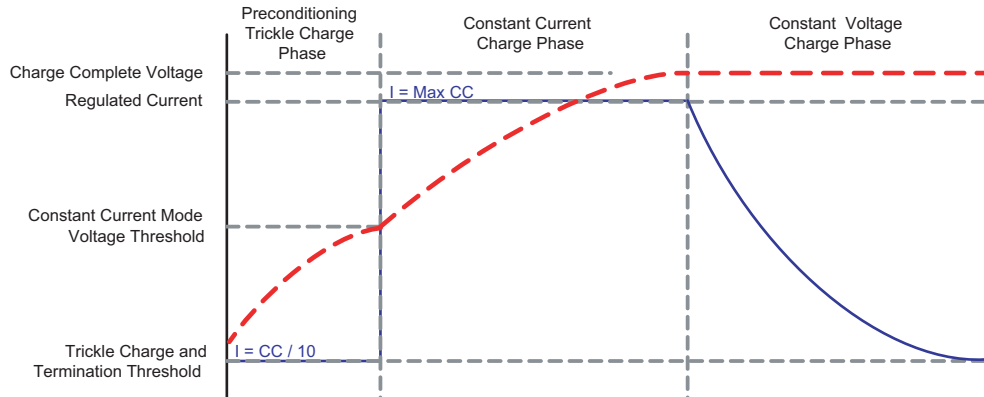

Figure 1: Current vs. Voltage Profile During Charging Phases.

Battery Preconditioning

Before the start of charging, the AAT3684 checks several conditions in order to assure a safe charging environment. The input supply must be above the minimum operating voltage, or under-voltage lockout threshold (V_{UVLO}), for the charging sequence to begin. When these conditions have been met and a battery is connected to the BAT pin, the AAT3684 checks the state of the battery. If the cell voltage is below the preconditioning voltage threshold (V_{MIN}), the charge control begins preconditioning the cell. The battery preconditioning trickle charge current is equal to the fast charge constant current divided by 10. For example, if the programmed fast charge current is 500mA, then the preconditioning mode (trickle charge) current will be 50mA. Cell preconditioning is a safety precaution for deeply discharged battery cells and also aids in limiting power dissipation in the pass transistor when the voltage across the device is at the greatest potential.

Constant Current Charging

Battery cell preconditioning continues until the voltage on the BAT pin exceeds the preconditioning voltage threshold (V_{MIN}). At this point, the AAT3684 begins the constant current charging phase. The charge constant current (I_{CH}) amplitude is programmed by the user via the R_{SET} resistor. The AAT3684 remains in the constant current charge mode until the battery reaches the voltage regulation point, V_{BAT_EOC} .

Constant Voltage Charging

The system transitions to a constant voltage charging mode when the battery voltage reaches the output charge regulation threshold (V_{BAT_EOC}) during the constant current fast charge phase. The regulation voltage level is factory programmed to 4.2V ($\pm 0.5\%$). Charge current in the constant voltage mode drops as the battery cell under charge reaches its maximum capacity.

End of Charge Cycle Termination and Recharge Sequence

When the charge current drops to 10% of the programmed fast charge current level in the constant voltage mode, the device terminates charging and goes into a sleep state. The charger will remain in a sleep state until the battery voltage decreases to a level below the battery recharge voltage threshold (V_{RCH}).

When the input supply is disconnected, the charger will automatically transition into a power-saving sleep mode. Only consuming an ultra-low 0.3 μ A in sleep mode, the AAT3684 minimizes battery drain when it is not charging. This feature is particularly useful in applications where the input supply level may fall below the battery charge or under-voltage lockout level. In such cases where the AAT3684 input voltage drops, the device will enter sleep mode and automatically resume charging once the input supply has recovered from the fault condition.

System Operation Flow Chart

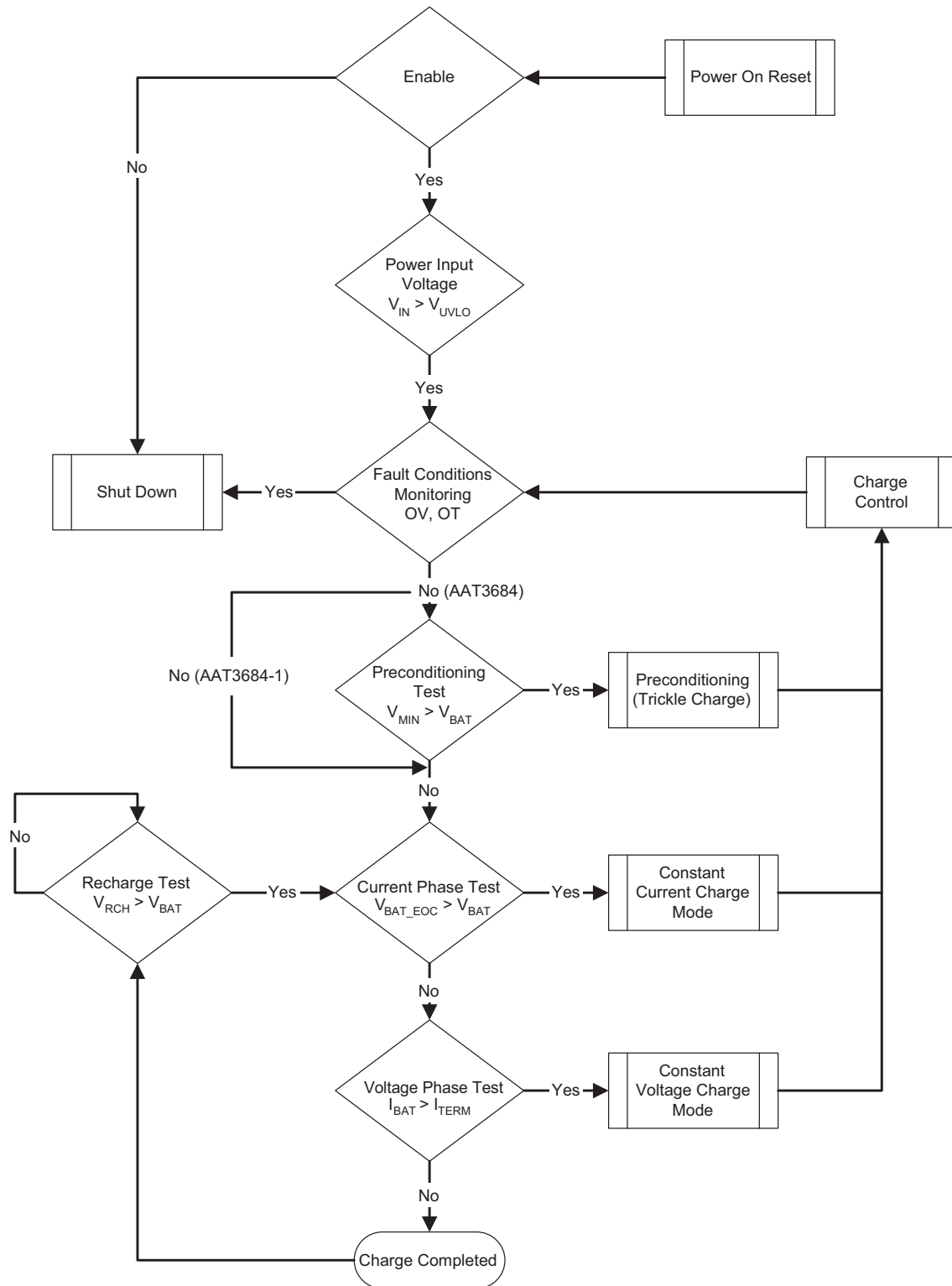

Application Information

Adapter or USB Power Input

Constant current charge levels up to 500mA may be programmed by the user when powered from a sufficient input power source. The AAT3684 will operate from the adapter input over a 4.0V to 6.5V range. The constant current fast charge current for the adapter input is set by the R_{SET} resistor connected between ISET and ground. Refer to Table 1 for recommended R_{SET} values for a desired constant current charge level.

Adapter Input Charge Inhibit and Resume

The AAT3684 has a UVLO and power on reset feature so that if the input supply to the ADP pin drops below the UVLO threshold, the charger will suspend charging and shut down. When power is re-applied to the ADP pin or the UVLO condition recovers, the system charge control will assess the state of charge on the battery cell and will automatically resume charging in the appropriate mode for the condition of the battery.

Enable / Disable

The AAT3684 provides an enable function to control the charger IC on and off. The enable (EN) pin is internally pulled down. When pulled to a logic high level, AAT3684 is enabled. When left open or pulled to a logic low level, the AAT3684 will be shut down and forced into the sleep state. Charging will be halted regardless of the battery voltage or charging state. When the device is re-enabled, the charge control circuit will automatically reset and resume charging functions with the appropriate charging mode based on the battery charge state and measured cell voltage on the BAT pin.

Programming Charge Current

The fast charge constant current charge level is user programmed with a set resistor placed between the ISET pin and ground. The accuracy of the fast charge, as well as the preconditioning trickle charge current, is dominated by the tolerance of the set resistor used. For this reason, a 1% tolerance metal film resistor is recommended for the set resistor function. Fast charge constant current levels from 15mA to 500mA may be set by selecting the appropriate resistor value from Table 1.

Nominal I_{CHARGE} (mA)	Set Resistor Value (k Ω)
500	3.24
450	3.57
400	4.12
350	4.64
300	5.36
250	6.49
200	8.06
150	10.7
100	16.2
50	31.6
40	38.3
30	53.6
20	78.7
15	105

Table 1: R_{SET} Values.

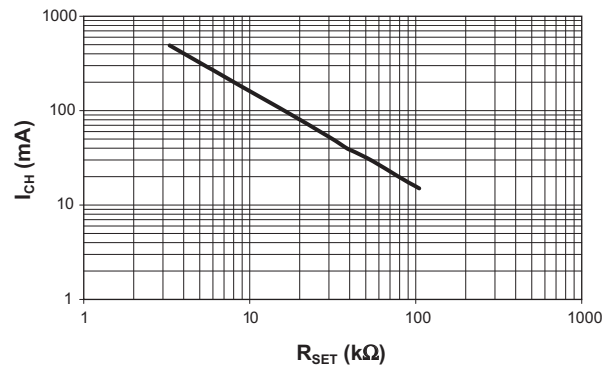

Figure 2: Constant Charging Current vs. Set Resistor Values.

Protection Circuitry

Over-Voltage Protection

An over-voltage event is defined as a condition where the voltage on the BAT pin exceeds the maximum battery charge voltage and is set by the over-voltage protection threshold (V_{OVP}). If an over-voltage condition occurs, the AAT3684 charge control will shut down the device until voltage on the BAT pin drops below V_{OVP} . The AAT3684 will resume normal charging operation after the over-voltage condition is removed.

Over-Temperature Shutdown

The AAT3684 has a thermal protection control circuit which will shut down charging functions should the internal die temperature exceed the preset thermal limit threshold. Once the internal die temperature falls below the thermal limit, the normal operation will resume the previous charging state.

Charge Status Output

The AAT3684 provides battery charge status via a status pin. This pin is internally connected to an N-channel open drain MOSFET, which can be used to drive an external LED. The status pin can indicate the following conditions:

Event Description	Status
No battery charging activity	OFF
Battery charging via adapter or USB port	ON
Charging completed	OFF

Table 2: LED Status Indicator.

The LED should be biased with as little current as necessary to create reasonable illumination; therefore, a ballast resistor should be placed between the LED cathode and the STAT pin. LED current consumption will add to the overall thermal power budget for the device package, hence it is good to keep the LED drive current to a minimum. 2mA should be sufficient to drive most low-cost green or red LEDs. It is not recommended to exceed 8mA for driving an individual status LED.

The required ballast resistor values can be estimated using the following formulas:

$$R_1 = \frac{(V_{ADP} - V_{F(LED)})}{I_{LED}}$$

Example:

$$R_1 = \frac{(5.5V - 2.0V)}{2mA} = 1.75k\Omega$$

Note: Red LED forward voltage (V_F) is typically 2.0V @ 2mA.

Thermal Considerations

The AAT3684 is offered in the STDFN2.2x2.2-10 package, which can provide up to 2W of power dissipation when it is properly bonded to a printed circuit board and has a maximum thermal resistance of 50°C/W. Many considerations should be taken into account when designing the printed circuit board layout, as well as the placement of the charger IC package in proximity to other heat generating devices in a given application design. The ambient temperature around the charger IC will also have an effect on the thermal limits of a battery charging application. The maximum limits that can be expected for a given ambient condition can be estimated by the following discussion.

First, the maximum power dissipation for a given situation should be calculated:

$$P_{D(MAX)} = \frac{(T_{J(MAX)} - T_A)}{\theta_{JA}}$$

Where:

- $P_{D(MAX)}$ = Maximum Power Dissipation (W)
- θ_{JA} = Package Thermal Resistance (°C/W)
- $T_{J(MAX)}$ = Maximum Device Junction Temperature (°C) [135°C]
- T_A = Ambient Temperature (°C)

Figure 3 shows the relationship of maximum power dissipation and ambient temperature of AAT3684.

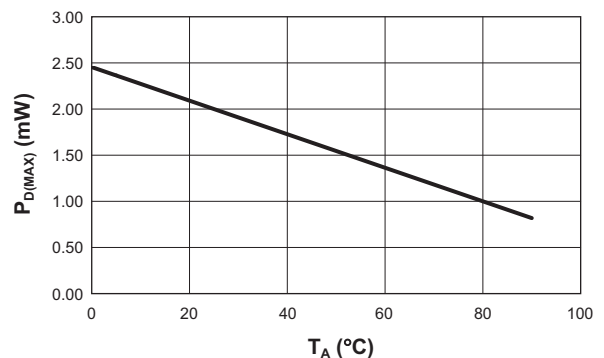

Figure 3: Maximum Power Dissipation.

Next, the power dissipation can be calculated by the following equation:

$$P_D = [(V_{IN} - V_{BAT}) \cdot I_{CC} + (V_{IN} \cdot I_{OP})]$$

Where:

- P_D = Total Power Dissipation by the Device
- V_{IN} = Input Voltage
- V_{BAT} = Battery Voltage as Seen at the BAT Pin
- I_{CC} = Constant Charge Current Programmed for the Application
- I_{OP} = Quiescent Current Consumed by the Charger IC for Normal Operation [0.5mA]

By substitution, we can derive the maximum charge current before reaching the thermal limit condition (thermal cycling). The maximum charge current is the key factor when designing battery charger applications.

$$I_{CC(MAX)} = \frac{(P_{D(MAX)} - V_{IN} \cdot I_{OP})}{V_{IN} - V_{BAT}}$$

$$I_{CC(MAX)} = \frac{(\frac{T_{J(MAX)} - T_A}{\theta_{JA}}) - V_{IN} \cdot I_{OP}}{V_{IN} - V_{BAT}}$$

In general, the worst condition is the greatest voltage drop across the charger IC, when battery voltage is charged up to the preconditioning voltage threshold. Figure 4 shows the maximum charge current in different ambient temperatures.

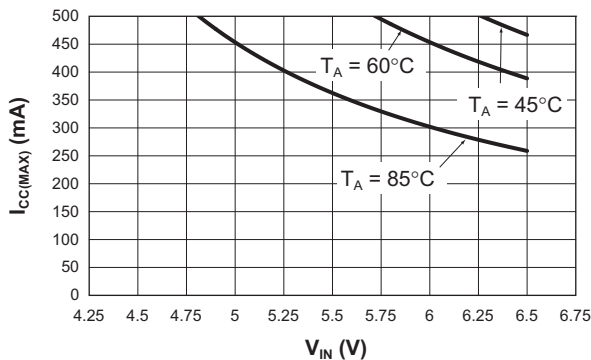

Figure 4: Maximum Charging Current Before Thermal Cycling Becomes Active.

Capacitor Selection

Input Capacitor

In general, it is good design practice to place a decoupling capacitor between the ADP pin and GND. An input capacitor in the range of 1µF to 22µF is recommended. If the source supply is unregulated, it may be necessary to increase the capacitance to keep the input voltage above the under-voltage lockout threshold during device enable and when battery charging is initiated. If the AAT3684 adapter input is to be used in a system with an external power supply source, such as a typical AC-to-DC wall adapter, then a C_{IN} capacitor in the range of 10µF should be used. A larger input capacitor in this application will minimize switching or power transient effects when the power supply is “hot plugged” in.

Output Capacitor

The AAT3684 only requires a 1µF ceramic capacitor on the BAT pin to maintain circuit stability. This value should be increased to 10µF or more if the battery connection is made any distance from the charger output. If the AAT3684 is to be used in applications where the battery can be removed from the charger, such as with desktop charging cradles, an output capacitor greater than 10µF may be required to prevent the device from cycling on and off when no battery is present.

Printed Circuit Board Layout Considerations

For the best results, it is recommended to physically place the battery pack as close as possible to the AAT3684 BAT pin. To minimize voltage drops on the PCB, keep the high current carrying traces adequately wide. Refer to the AAT3684 evaluation board for a good layout example (see Figures 5 and 6).

For better thermal enhancement, solder the exposed paddle of the IC onto the thermal landing of the PCB, where the thermal landing is connected to the ground plane. If heat is still an issue, multi-layer boards with dedicated ground planes are recommended. Adding more thermal vias on the thermal landing will also help transfer heat to the PCB effectively. Figure 7 illustrates the exploded view of the layout at the bottom of the IC.

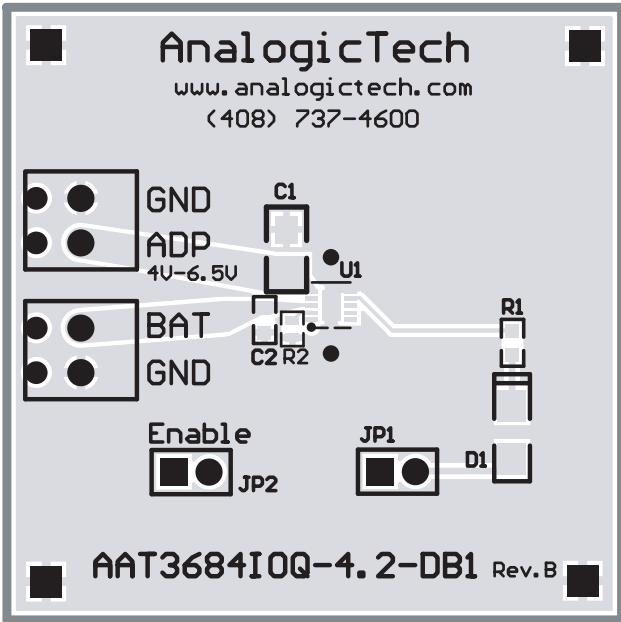

Figure 5: AAT3684 Evaluation Board Top Layer.

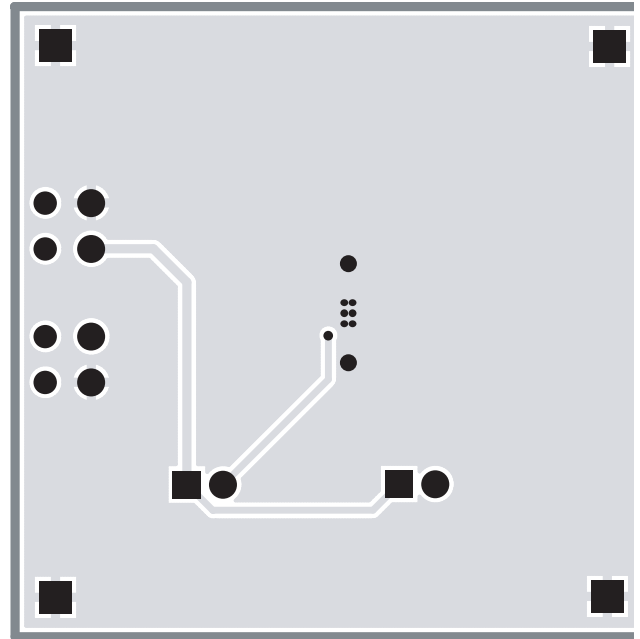

Figure 6: AAT3684 Evaluation Board Bottom Layer.

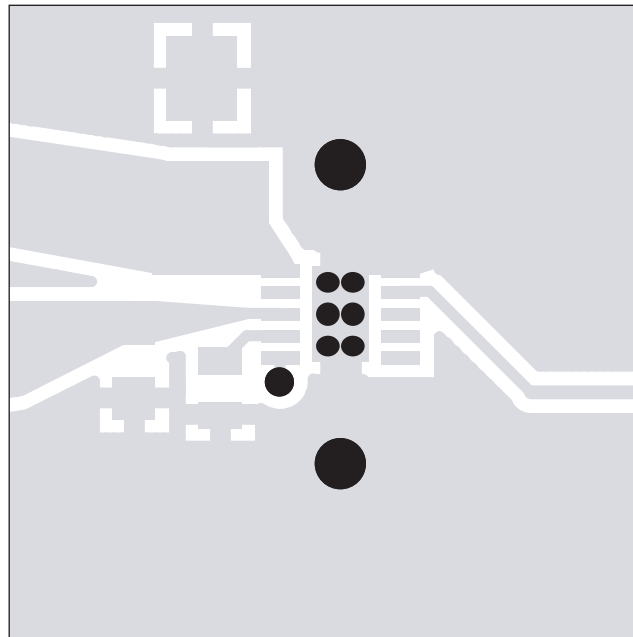
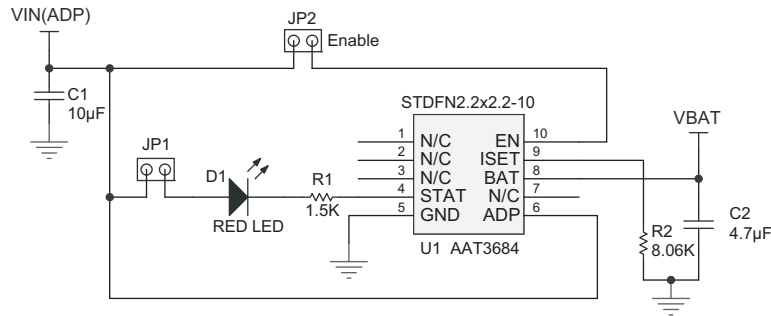

Figure 7: Exploded View of the Layout.



C1 10µF 10V 10% X5R 0805 GRM21BR61A106KE19
C2 4.7µF 6.3V 10% X5R 0603 GRM188R60J475KE19

Figure 8: AAT3684 Evaluation Board Schematic.

Component	Part Number	Description	Manufacturer
U1	AAT3684IOQ-T1	500mA USB Port or AC Adapter Battery Charger; STDFN2.2x2.2-10 Package	AnalogicTech
R1	Chip Resistor	1.5KΩ, 5%, 1/4W; 0603	Vishay
R2	Chip Resistor	8.06KΩ, 1%, 1/4W; 0603	Vishay
C1	GRM21BR61A106KE19	CER 10µF 10V 10% X5R 0805	Murata
C2	GRM188R60J475KE19	CER 4.7µF 6.3V 10% X5R 0603	Murata
JP1, JP2	PRPN401PAEN	Conn. Header, 2mm zip	Sullins Electronics
LED1	CMD15-21SRC/TR8	Red LED; 1206	Chicago Miniature Lamp

Table 3: AAT3684 Evaluation Board Bill of Materials.



BatteryManager™ 500mA USB Port or AC Adapter Lithium-Ion/Polymer Battery Charger

Ordering Information

Trickle Charge	Package	Marking ¹	Part Number (Tape and Reel) ²
Yes	STDFN2.2x2.2-10	TNXY	AAT3684IOQ-4.2-T1
No	STDFN2.2x2.2-10	TXXY	AAT3684IOQ-4.2-1-T1



All AnalogicTech products are offered in Pb-free packaging. The term "Pb-free" means semiconductor products that are in compliance with current RoHS standards, including the requirement that lead not exceed 0.1% by weight in homogeneous materials. For more information, please visit our website at <http://www.analogictech.com/pbfree>.

1. XYY = assembly and date code.

2. Sample stock is generally held on part numbers listed in BOLD.

Package Information

STDFN2.2x2.2-10

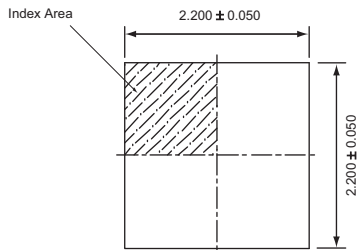

Top View

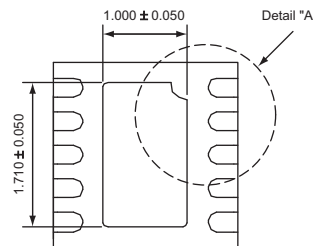

Bottom View



Side View

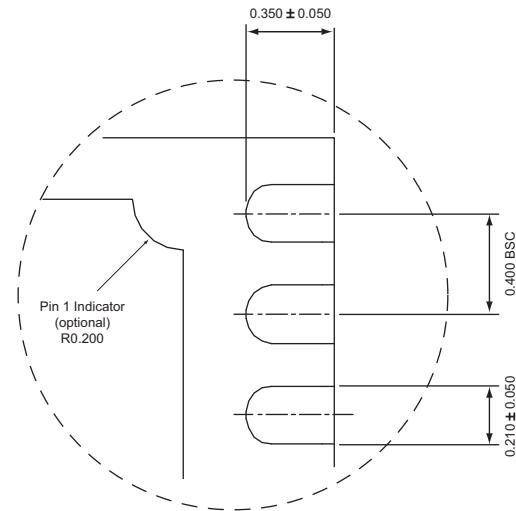

Detail "A"

All dimensions in millimeters.

1. The leadless package family, which includes QFN, TQFN, DFN, TDFN and STDFN, has exposed copper (unplated) at the end of the lead terminals due to the manufacturing process. A solder fillet at the exposed copper edge cannot be guaranteed and is not required to ensure a proper bottom solder connection.

Advanced Analogic Technologies, Inc.
 3230 Scott Boulevard, Santa Clara, CA 95054
 Phone (408) 737-4600
 Fax (408) 737-4611