

**3.5V 400mA Low Dropout Regulator****Features**

- Dropout voltage typically 0.8V @ $I_o = 400\text{mA}$
- Output current in excess of 400mA
- Output voltage accuracy +3%/-2%
- Quiescent current, typically 600 μA
- Internal short circuit current limit
- Internal over temperature protection

General Description

The G930/G931 positive 3.5V voltage regulator features the ability to source 400mA of output current with a dropout voltage of typically 0.8V over the entire operating temperature range. A low quiescent current is provided over the entire output current range. The typical quiescent current is 0.6mA. Furthermore, the quiescent current is smaller when the regulator is in the dropout mode ($V_{IN} < 3.5\text{V}$).

Familiar regulator features such as over temperature and over current protection circuits are provided to prevent it from being damaged by abnormal operating conditions.

Ordering Information

ORDER NUMBER	PACKAGE TYPE	PIN OPTION		
		1	2	3
G930T21U	SOT 89	V_{OUT}	GND	V_{IN}
G931T24U	SOT 89	GND	V_{IN}	V_{OUT}

* For other package types, pin options and package, please contact us at sales @gmt.com.tw

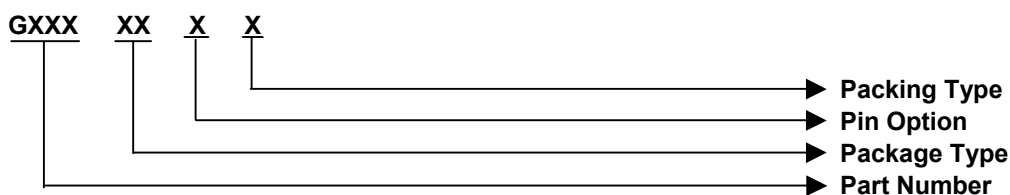
Order Number Identification**PACKAGE TYPE**

T2 : SOT 89
T6 : SOT 223
T7 : SOT 23
T8 : $\mu\text{TO}92$

PIN OPTION

1	2	3
1 : V_{OUT}	GND	V_{IN}
2 : V_{OUT}	V_{IN}	GND
3 : GND	V_{OUT}	V_{IN}
4 : GND	V_{IN}	V_{OUT}
5 : V_{IN}	GND	V_{OUT}
6 : V_{IN}	V_{OUT}	GND

PACKING

U & D : Tape & Reel Direction
T : Tube
B : Bag

Typical Application

[Note 4] : Type of C_{OUT}

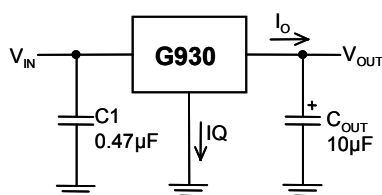
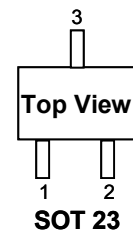
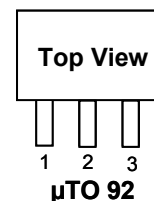
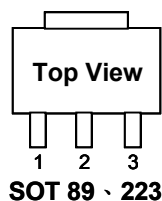
**Package Type**



Absolute Maximum Ratings	(Note 1)
Input Voltage.....	10V
Power Dissipation Internally Limited	(Note 2)
Maximum Junction Temperature.....	150°C
Storage Temperature Range.....	-65°C ≤ T _J ≤ +150°C
Lead Temperature, Time for Wave Soldering	
SOT-89 Package.....	260°C, 4s
Continuous Power Dissipation (T _A = +25°C)	
SOT89 ⁽¹⁾	0.42W

Note ⁽¹⁾: See Recommended Minimum Footprint.

Operating Conditions	(Note 1)
Input Voltage.....	4V~7V
Temperature Range.....	0°C ≤ T _J ≤ 125°C

Electrical Characteristics

V_{IN} = 5V, I_O = 400mA, C_{IN} = 1μF, C_{OUT} = 10 μF, All specifications apply for T_A = T_J = 25°C. [Note 3]

PARAMETER	CONDITIONS	MIN	TYP	MAX	UNITS
Output Voltage	5mA ≤ I _O ≤ 400mA	3.43	3.5	3.605	V
Line Regulation	4V ≤ V _{IN} ≤ 7V, I _O = 10mA		22		mV
Load Regulation	50mA ≤ I _O ≤ 400mA		30		mV
Output Impedance	100mA DC and 100mA AC, f _o = 120Hz		103		mΩ
Quiescent Current	V _{IN} = 5V		0.6		mA
Ripple Rejection	f _r = 120Hz, 1V _{P-P} , I _O = 100mA		42		dB
Dropout Voltage	I _O = 400mA		0.8	0.9	V
	I _O = 100mA		125	150	mV
Short Circuit Current			0.77		A
Over Temperature			125		°C

Note 1: Absolute Maximum Ratings are limits beyond which damage to the device may occur. Operating Conditions are conditions under which the device functions but the specifications might not be guaranteed. For guaranteed specifications and test conditions see the Electrical Characteristics.

Note2: The maximum power dissipation is a function of the maximum junction temperature, T_{Jmax}; total thermal resistance, θ_{JA}, and ambient temperature T_A. The maximum allowable power dissipation at any ambient temperature is T_{Jmax}-T_A / θ_{JA}. If this dissipation is exceeded, the die temperature will rise above 130°C and IC will go into thermal shutdown. For the G930/G931 in SOT 89 package, θ_{JA} is 250°C/W. (See Recommended Minimum Footprint). The safe operation in SOT 89, it can see "Typical Performance Characteristics" (Safe Operating Area).

Note3: Low duty pulse techniques are used during test to maintain junction temperature as close to ambient as possible.

Note4: The type of output capacitor should be tantalum or aluminum.

Definitions

Dropout Voltage

The input/output Voltage differential at which the regulator output no longer maintains regulation against further reductions in input voltage. Measured when the output drops 100mV below its nominal value, dropout voltage is affected by junction temperature, load current and minimum input supply requirements.

Line Regulation

The change in output voltage for a change in input voltage. The measurement is made under conditions of low dissipation or by using pulse techniques such that average chip temperature is not significantly affected.

Load Regulation

The change in output voltage for a change in load current at constant chip temperature. The measurement is made under conditions of low dissipation or by using pulse techniques such that average chip temperature is not significantly affected.

Maximum Power Dissipation

The maximum total device dissipation for which the regulator will operate within specifications.

Quiescent Bias Current

Current which is used to operate the regulator chip and is not delivered to the load.



Typical Performance Characteristics

(VIN=5V, CIN=1μF, COUT=10μF, TA=25°C, unless otherwise noted.)

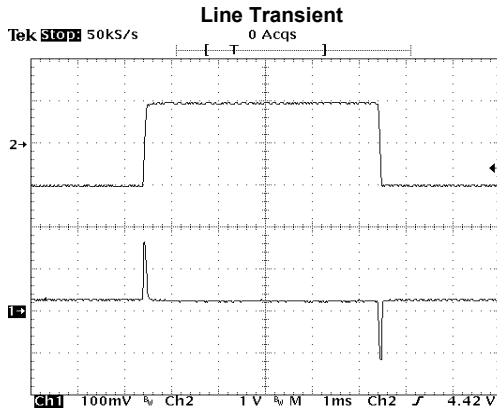

Ch1: Vout (offset=3.50V)
Ch2: Vin (offset=5.0V)
Iout=100mA

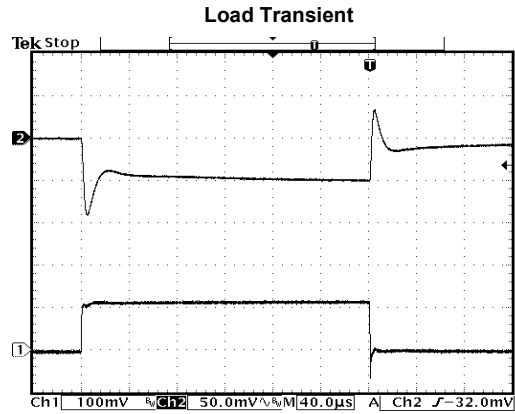

Ch1: Iout (400mA/div)
Ch2: Vout (offset=3.50V)

Output Voltage vs. Load Current

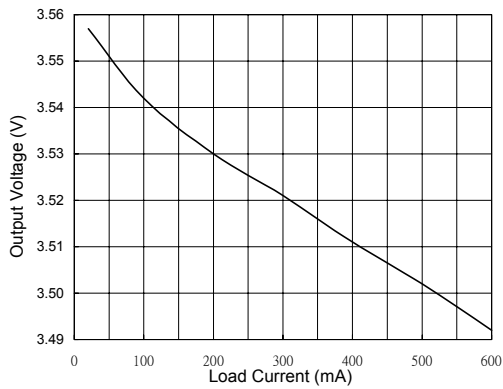

Dropout Voltage vs. Load Current

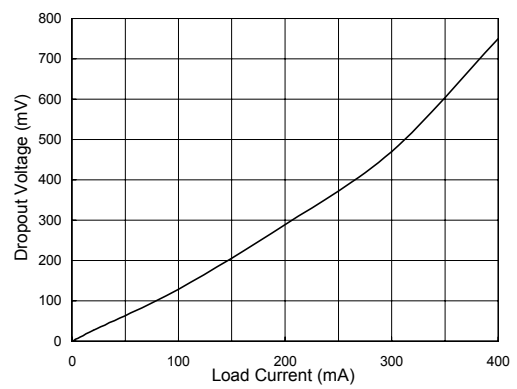

Ground Current vs. Load Current

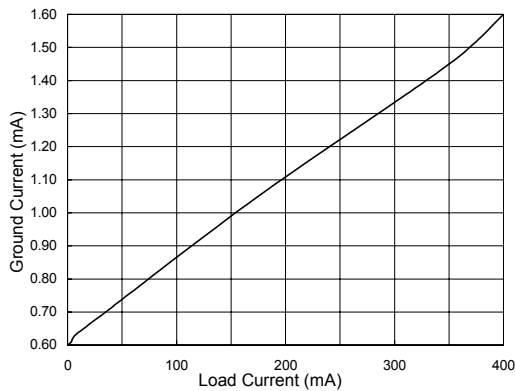



Safe Operating Area [Power Dissipation Limit]

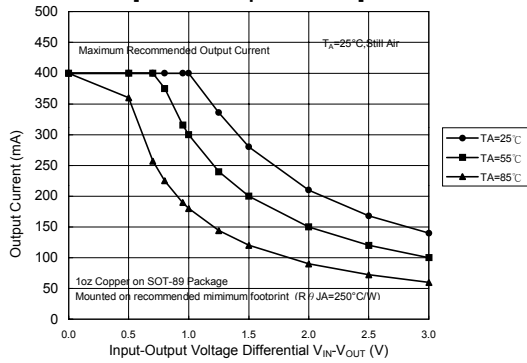

Note: $V_{IN(max)} \leq 6.5\text{V}$

Maximum Power Dissipation of SOT-89

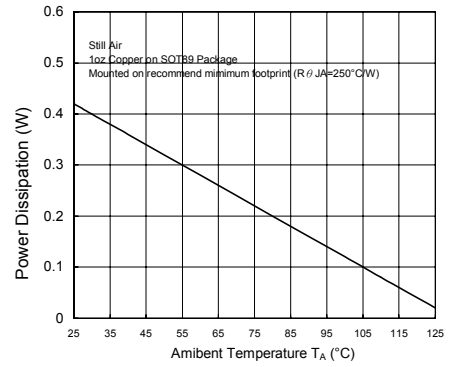

Recommended Minimum Footprint

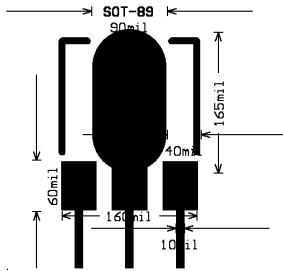

Package Information

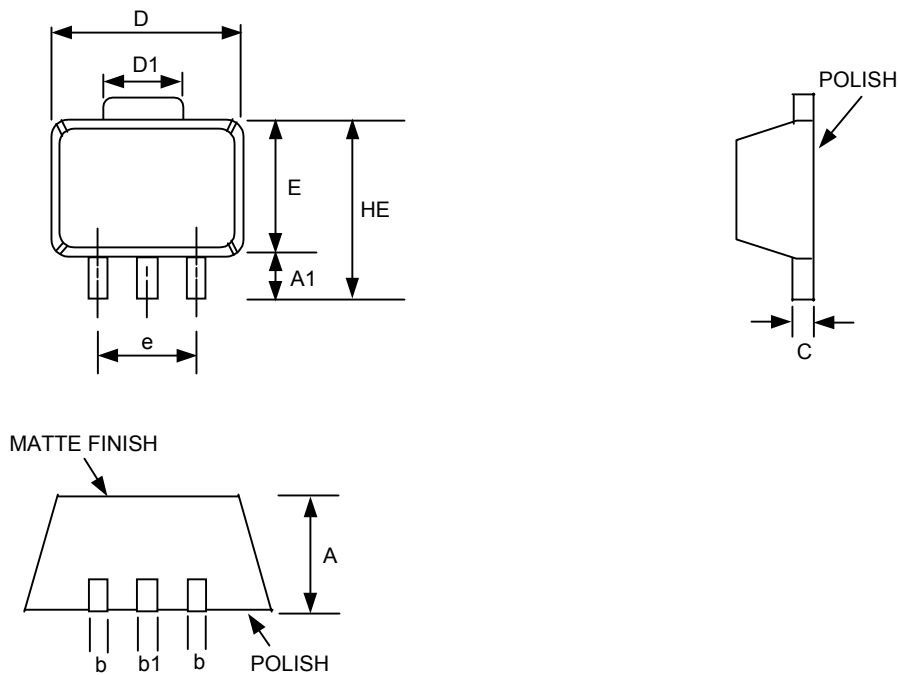

SOT- 89 (T2) Package

SYMBOLS	DIMENSIONS IN MILLIMETERS			DIMENSIONS IN INCHES		
	MIN	NOM	MAX	MIN	NOM	MAX
A	1.40	1.50	1.60	0.055	0.059	0.063
A1	0.80	1.04	-----	0.031	0.041	-----
b	0.36	0.42	0.48	0.014	0.016	0.048
b1	0.41	0.47	0.53	0.016	0.018	0.020
C	0.38	0.40	0.43	0.014	0.015	0.017
D	4.40	4.50	4.60	0.173	0.177	0.181
D1	1.40	1.60	1.75	0.055	0.062	0.069
HE	-----	-----	4.25	-----	-----	0.167
E	2.40	2.50	2.60	0.094	0.098	0.102
e	2.90	3.00	3.10	0.114	0.118	0.122

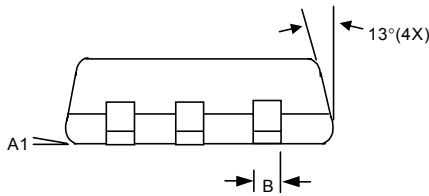
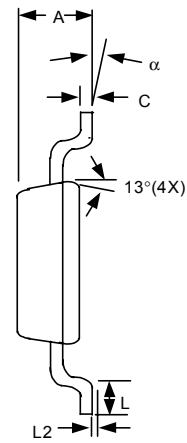
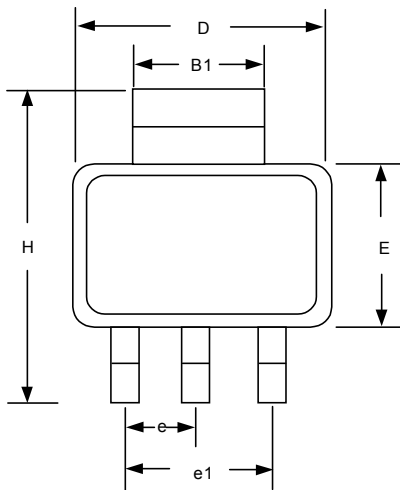

SOT-223 (T6) Package

SYMBOLS	MILLIMETERS		INCHES	
	MIN	MAX	MIN	MAX
A	1.55	1.80	0.061	0.071
A1	0.02	0.12	0.0008	0.0047
B	0.60	0.80	0.024	0.031
B1	2.90	3.10	0.114	0.122
C	0.24	0.32	0.009	0.013
D	6.30	6.70	0.248	0.264
E	3.30	3.70	0.130	0.146
e	2.30 BSC		0.090 BSC	
e1	4.60 BSC		0.181 BSC	
H	6.70	7.30	0.264	0.287
L	0.90 MIN		0.036 MIN	
L2	0.06 BSC		0.0024 BSC	
α	0°	10°	0°	10°

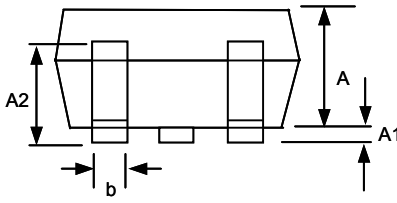
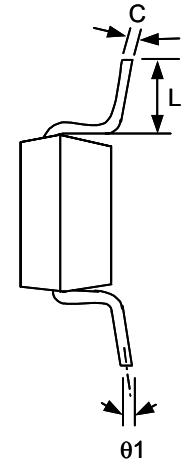
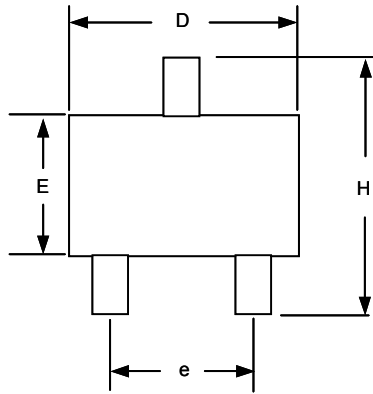

SOT 23 (T7) Package

Note:

1. Package body sizes exclude mold flash protrusions or gate burrs
2. Tolerance ± 0.1000 mm (4mil) unless otherwise specified
3. Coplanarity: 0.1000mm
4. Dimension L is measured in gage plane

SYMBOLS	DIMENSIONS IN MILLIMETERS		
	MIN	NOM	MAX
A	1.00	1.10	1.30
A1	0.00	-----	0.10
A2	0.70	0.80	0.90
b	0.35	0.40	0.50
C	0.10	0.15	0.25
D	2.70	2.90	3.10
E	1.40	1.60	1.80
e	-----	1.90(TYP)	-----
H	2.60	2.80	3.00
L	0.37	-----	-----
$\theta 1$	1°	5°	9°

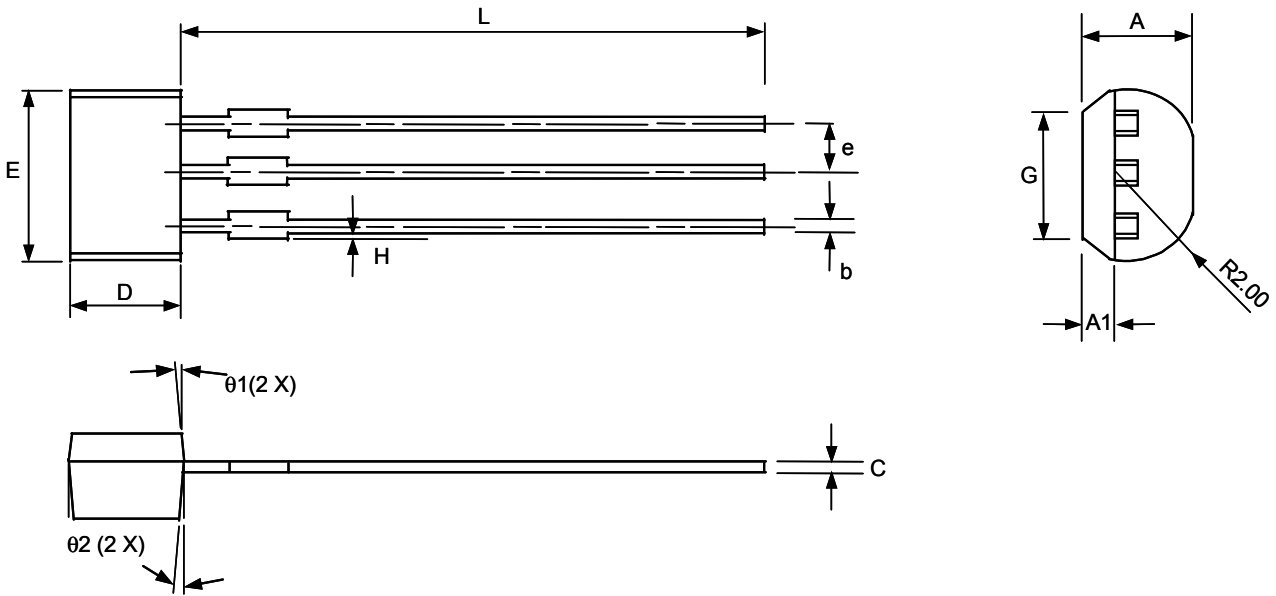

μTO-92 (T8) Package

SYMBOLS	DIMENSIONS IN MILLIMETERS			DIMENSIONS IN INCHES		
	MIN	NOM	MAX	MIN	NOM	MAX
A	2.40	2.50	2.60	0.094	0.098	0.102
A1	0.70	0.80	0.90	0.028	0.032	0.036
b	0.35	0.45	0.55	0.014	0.018	0.022
C	-----	0.40	-----	-----	0.016	-----
D	2.80	3.00	3.20	0.110	0.118	0.126
E	3.80	4.00	4.20	0.149	0.157	0.165
e	-----	1.27	-----	-----	0.050	-----
F	1.91	2.11	2.31	0.075	0.083	0.091
G	3.35	3.55	3.75	0.132	0.140	0.148
H	0.00	-----	0.15	0.000	-----	0.006
L	13.80	14.00	14.20	0.543	0.551	0.559
θ1	-----	2°	-----	-----	2°	-----
θ2	-----	5°	-----	-----	5°	-----

Package Orientation

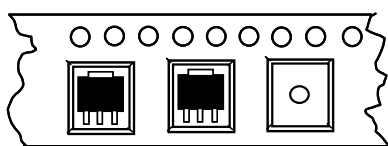

SOT 89 / 223 Package Orientation

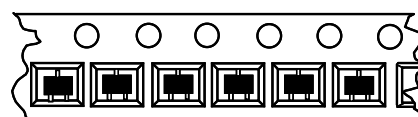

SOT 23 Package Orientation

GMT Inc. does not assume any responsibility for use of any circuitry described, no circuit patent licenses are implied and GMT Inc. reserves the right at any time without notice to change said circuitry and specifications.