

# 2SA1722, 2SC4498



2059

T-37-13  
T-35-11  
PNP/NPN Epitaxial Planar  
Silicon Transistors

## Switching Applications (with Bias Resistances R1=2.2kΩ, R2=10kΩ)

©3014

**Features**

- Contains bias resistances (R1=2.2kΩ, R2=10kΩ).
- Very small-sized package(MCP) permitting the 2SA1722/2SC4498-applied sets to be made small and slim.

( ): 2SA1722

**Absolute Maximum Ratings at Ta=25°C**

			unit
Collector to Base Voltage	V <sub>CB0</sub>	(-)50	V
Collector to Emitter Voltage	V <sub>CEO</sub>	(-)50	V
Emitter to Base Voltage	V <sub>EBO</sub>	(-)6	V
Collector Current	I <sub>C</sub>	(-)100	mA
Peak Collector Current	i <sub>cp</sub>	(-)200	mA
Collector Dissipation	P <sub>C</sub>	150	mW
Junction Temperature	T <sub>J</sub>	150	°C
Storage Temperature	T <sub>stg</sub>	-55 to +150	°C

**Electrical Characteristics at Ta=25°C**

			min	typ	max	unit
Collector Cutoff Current	I <sub>CB0</sub>	V <sub>CB</sub> =(-)40V, I <sub>E</sub> =0			(-)0.1	μA
Collector Cutoff Current	I <sub>CEO</sub>	V <sub>CB</sub> =(-)40V, I <sub>B</sub> =0			(-)0.5	μA
Emitter Cutoff Current	I <sub>EBO</sub>	V <sub>EB</sub> =(-)5V, I <sub>C</sub> =0	(-)315	(-)410	(-)590	μA
DC Current Gain	h <sub>FE</sub>	V <sub>CE</sub> =(-)5V, I <sub>C</sub> =(-)10mA	50			
Gain-Bandwidth Product	f <sub>T</sub>	V <sub>CE</sub> =(-)10V, I <sub>C</sub> =(-)5mA		(200)250		MHz
Output Capacitance	c <sub>ob</sub>	V <sub>CB</sub> =(-)10V, f=1MHz		(5.3)3.5		pF
C-E Saturation Voltage	V <sub>CE(sat)</sub>	I <sub>C</sub> =(-)10mA, I <sub>B</sub> =(-)0.5mA		(-)0.1	(-)0.3	V
C-B Breakdown Voltage	V <sub>(BR)CBO</sub>	I <sub>C</sub> =(-)10μA, I <sub>E</sub> =0	(-)50			V
C-E Breakdown Voltage	V <sub>(BR)CEO</sub>	I <sub>C</sub> =(-)100μA, R <sub>BE</sub> =∞	(-)50			V
Input OFF-State Voltage	V <sub>I(off)</sub>	V <sub>CE</sub> =(-)5V, I <sub>C</sub> =(-)100μA	(-)0.5	(-)0.7	(-)0.9	V
Input ON-State Voltage	V <sub>I(on)</sub>	V <sub>CE</sub> =(-)0.2V, I <sub>C</sub> =(-)10mA	(-)0.7	(-)1.0	(-)1.8	V
Input Resistance	R <sub>1</sub>		1.5	2.2	2.9	kΩ
Resistance Ratio	R <sub>1</sub> /R <sub>2</sub>		0.198	0.22	0.242	

Marking 2SA1722 : HL, 2SC4498 : QY

**Electrical Connection**

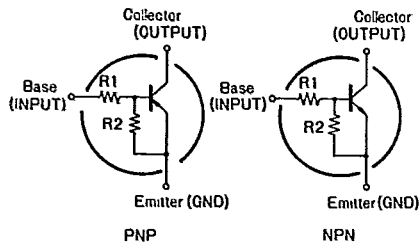

**Case Outline 2059  
(unit : mm)**

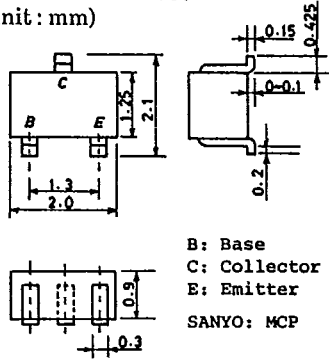

B: Base  
C: Collector  
E: Emitter  
SANYO: MCP



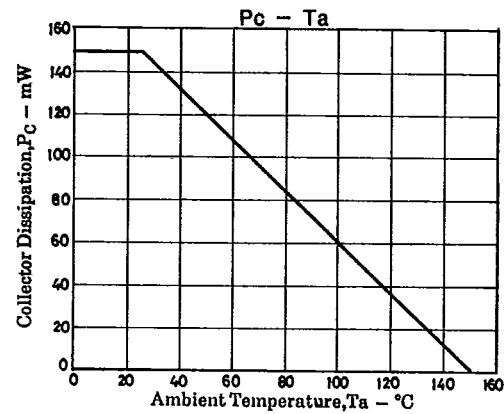
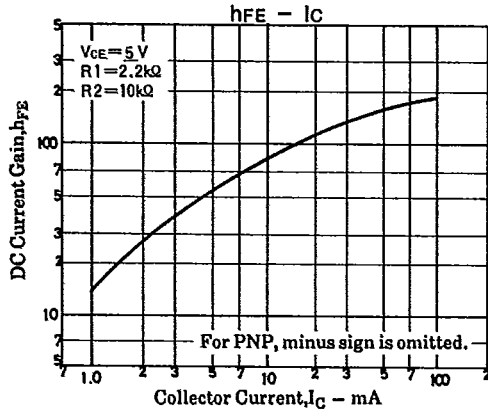
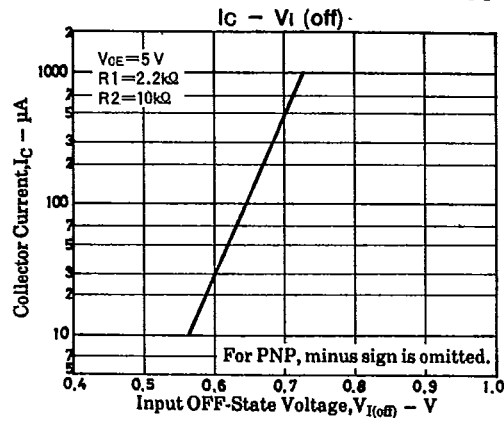
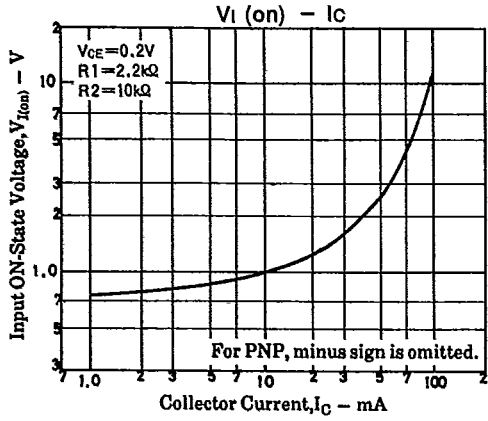

T-91-20

# CASE OUTLINES OF SURFACE MOUNT TRANSISTORS

- All of Sanyo surface mount transistor case outlines are illustrated below.
- All dimensions are in mm, and dimensions which are not followed by min. or max. are represented by typical values.
- No marking is indicated.

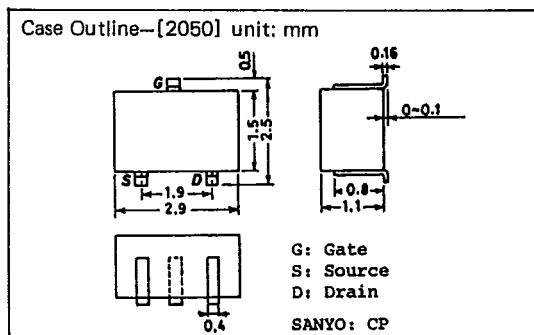
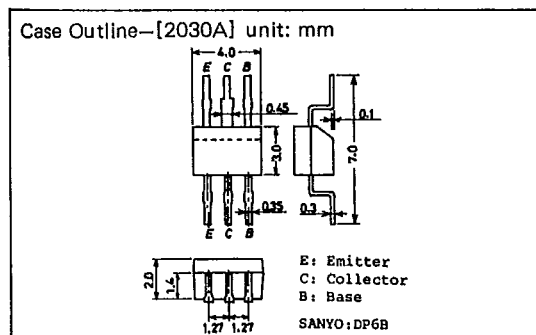
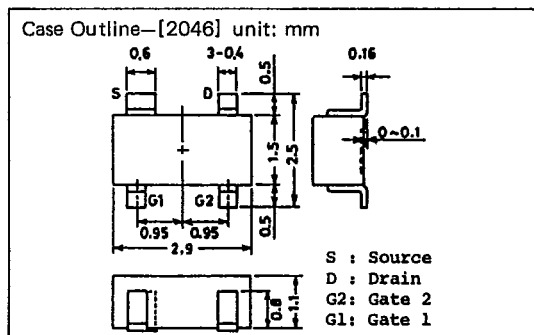
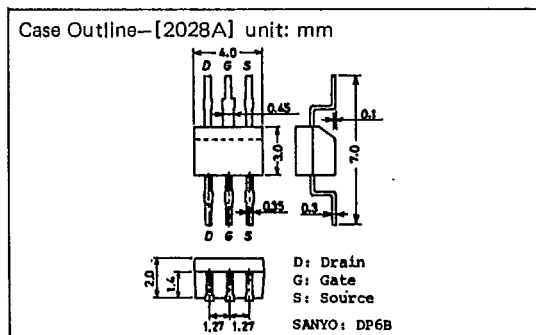
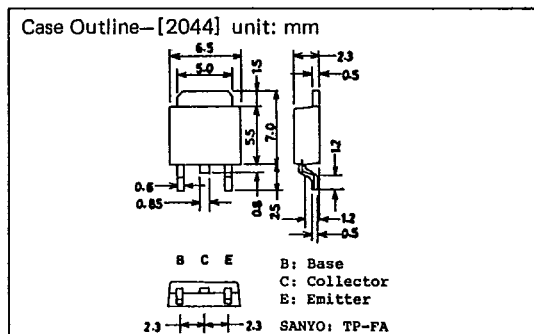
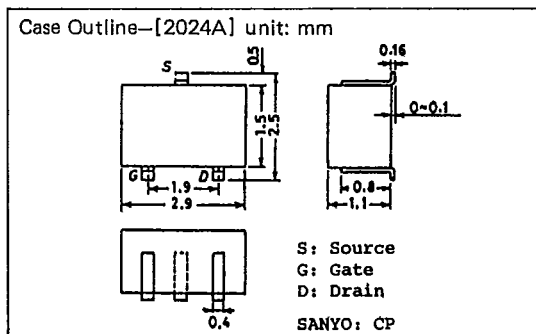
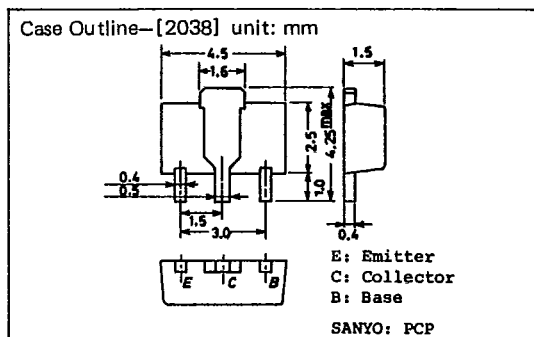
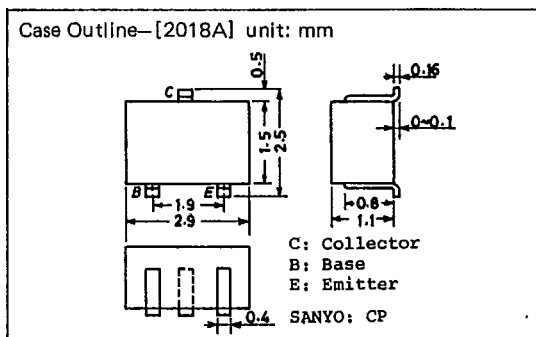

T-91-20

Case Outline—[2057] unit: mm

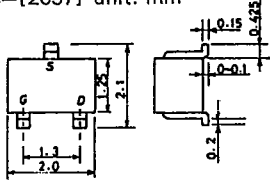

S: Source  
G: Gate  
D: Drain  
SANYO: MCP

Case Outline—[2066] unit: mm

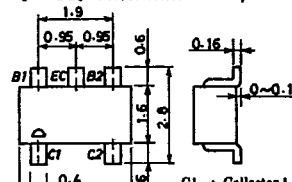

C1 : Collector 1  
C2 : Collector 2  
B2 : Base 2  
EC : Emitter Common  
B1 : Base 1  
SANYO : CP6

Case Outline—[2058] unit: mm

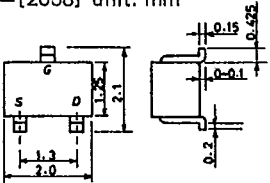

G: Gate  
S: Source  
D: Drain  
SANYO: MCP

Case Outline—[2067] unit: mm

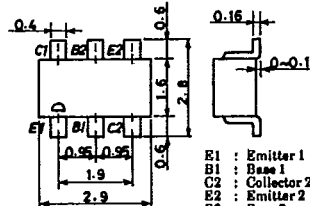

E1 : Emitter 1  
B1 : Base 1  
C2 : Collector 2  
E2 : Emitter 2  
B2 : Base 2  
C1 : Collector 1  
SANYO : CP6

Case Outline—[2059] unit: mm

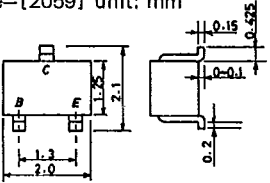

B: Base  
C: Collector  
E: Emitter  
SANYO: MCP

Case Outline—[2068] unit: mm

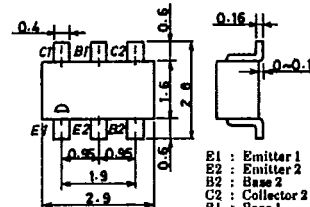

B1 : Emitter 1  
E2 : Emitter 2  
B2 : Base 2  
C2 : Collector 2  
B1 : Base 1  
C1 : Collector 1  
SANYO : CP6

Case Outline—[2062] unit: mm

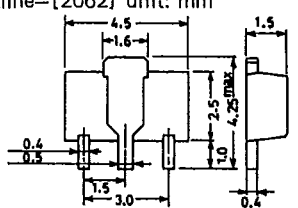

S: Source  
D: Drain  
G: Gate  
SANYO: PCP

Case Outline—[2069] unit: mm

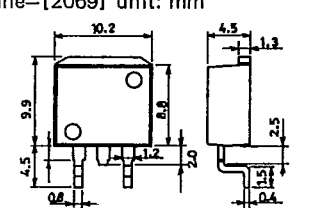

B: Base  
C: Collector  
E: Emitter  
SANYO: SMP

Case Outline—[2065] unit: mm

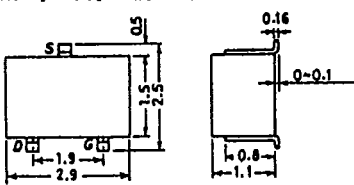

S: Source  
D: Drain  
G: Gate  
SANYO: CP

Case Outline—[2070] unit: mm

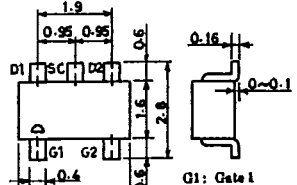

G1 : Gate 1  
G2 : Gate 2  
D2 : Drain 2  
SC : Source Common  
D1 : Drain 1  
SANYO : CP6

T-9120

