

HIGH SPEED SWITCHING
PNP SILICON EPITAXIAL TRANSISTOR
MINI MOLD

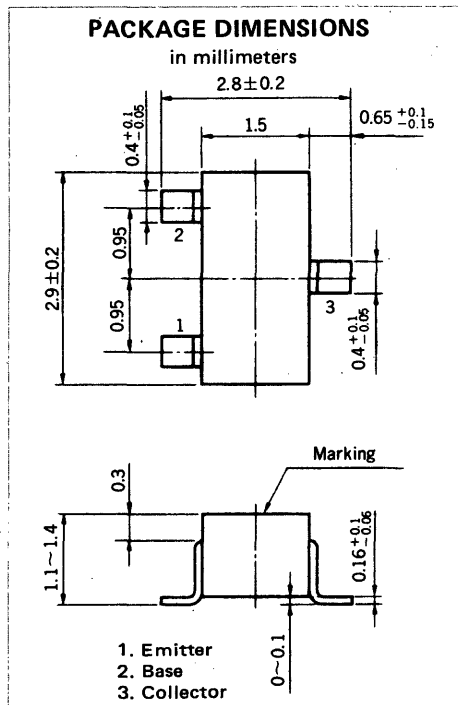

FEATURES

- High Speed Switching : $t_{on} = 9.0$ ns TYP.
 $t_{off} = 19.0$ ns TYP.
- High f_T : $f_T = 1\ 800$ MHz TYP.
- Low C_{ob} : $C_{ob} = 2.0$ pF TYP.
- Complementary to 2SC3735

ABSOLUTE MAXIMUM RATINGS

Maximum Voltages and Current ($T_a = 25^\circ\text{C}$)

Collector to Base Voltage	V_{CBO}	-15	V
Collector to Emitter Voltage	V_{CEO}	-15	V
Emitter to Base Voltage	V_{EBO}	-4.5	V
Collector Current (DC)	I_C	-50	mA

Maximum Power Dissipation

Total power Dissipation at 25°C Ambient Temperature	P_T	200	mW
--	-------	-----	----

Maximum Temperatures

Junction Temperature	T_j	150	$^\circ\text{C}$
Storage Temperature Range	T_{stg}	-55 to +150	$^\circ\text{C}$

ELECTRICAL CHARACTERISTICS ($T_a = 25^\circ\text{C}$)

CHARACTERISTIC	SYMBOL	MIN.	TYP.	MAX.	UNIT	TEST CONDITIONS
Collector Cutoff Current	I_{CBO}			-100	nA	$V_{CB} = -8.0$ V, $I_E = 0$
Emitter Cutoff Current	I_{EBO}			-100	nA	$V_{EB} = -3.0$ V, $I_C = 0$
DC Current Gain	h_{FE1} *	30	70			$V_{CE} = -1.0$ V, $I_C = -1.0$ mA
DC Current Gain	h_{FE2} *	50	80	150		$V_{CE} = -1.0$ V, $I_C = -10$ mA
Collector Saturation Voltage	$V_{CE(sat)}$ *		-0.09	-0.20	V	$I_C = -10$ mA, $I_B = -1.0$ mA
Base Saturation Voltage	$V_{BE(sat)}$ *		-0.80	-0.95	V	$I_C = -10$ mA, $I_B = -1.0$ mA
Gain Bandwidth Product	f_T	800	1800		MHz	$V_{CE} = -10$ V, $I_E = 10$ mA
Output Capacitance	C_{ob}		2.0	3.0	pF	$V_{CB} = -5.0$ V, $I_E = 0$, $f = 1.0$ MHz
Turn-on Time	t_{on}		9.0	20	ns	$I_C = -10$ mA $I_{B1} = -I_{B2} = -1.0$ mA
Storage Time	t_{stg}		16	40	ns	
Turn-off Time	t_{off}		19	40	ns	

* Pulsed: $PW \leq 350$ μs , Duty Cycle $\leq 2\%$

h_{FE2} Classification

Making	Y33	Y34
h_{FE2}	50 to 100	75 to 150

TYPICAL CHARACTERISTICS ($T_a = 25^\circ\text{C}$)

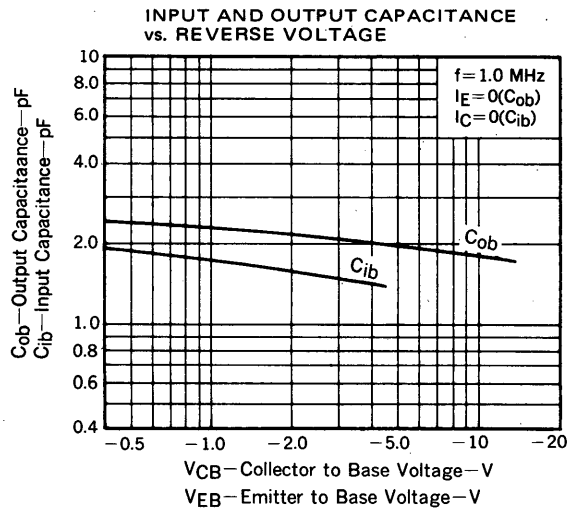
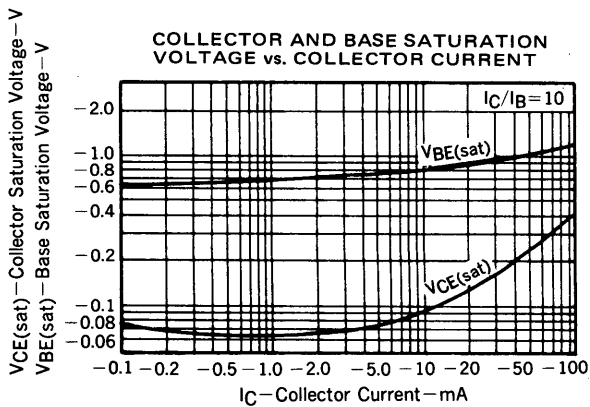
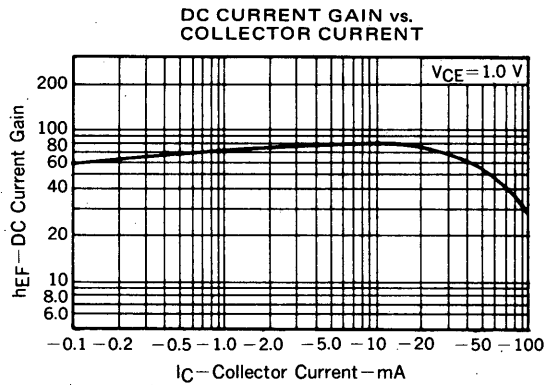
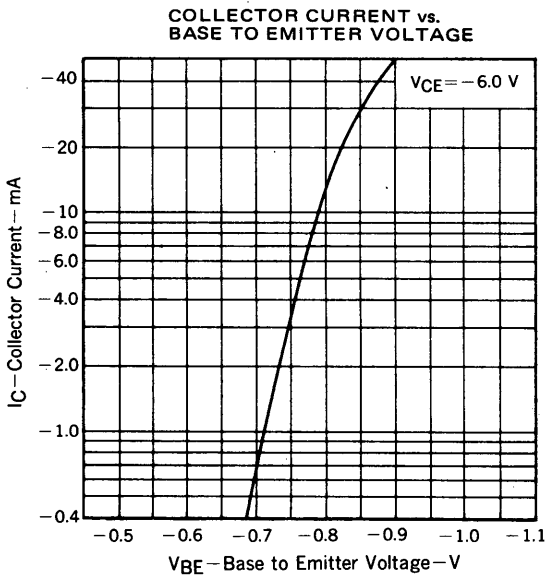
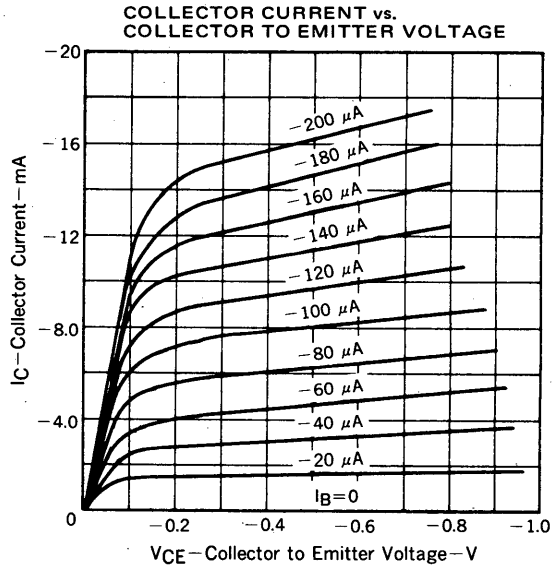
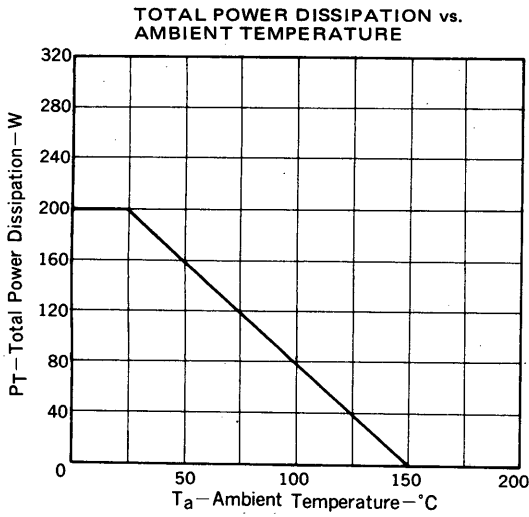

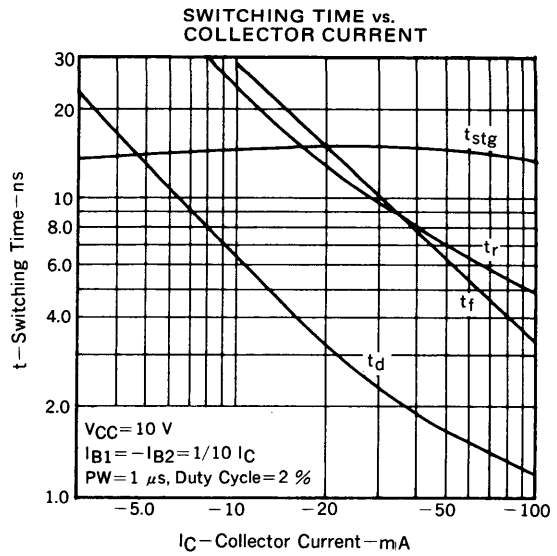
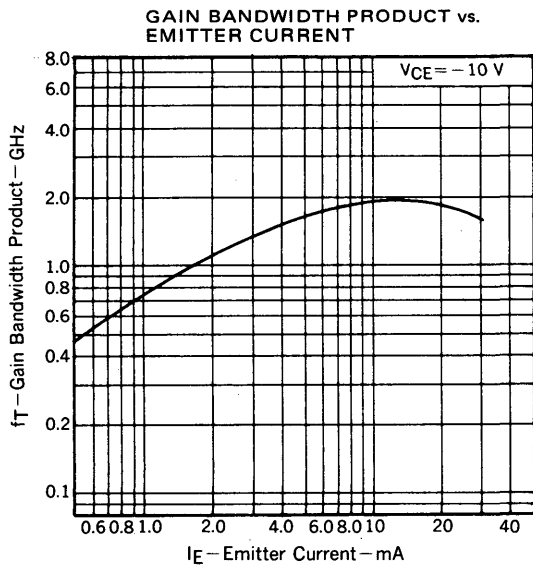

SWITCHING TIME TEST CIRCUIT

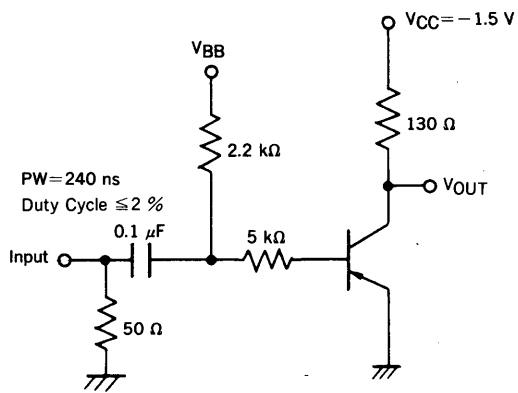

t_{on}, t_{off} Switching

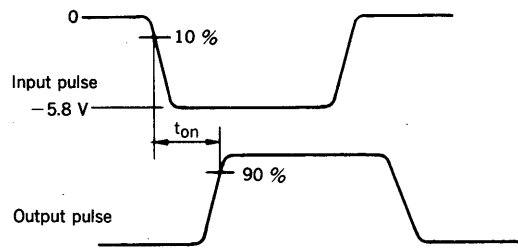

t_{on} Voltage Waveforms ($V_{BB} = \text{GROUND}$)

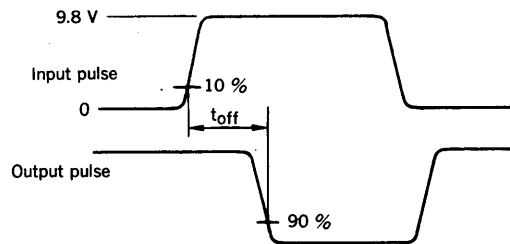

t_{off} Voltage Waveforms ($V_{BB} = -8.0\text{ V}$)

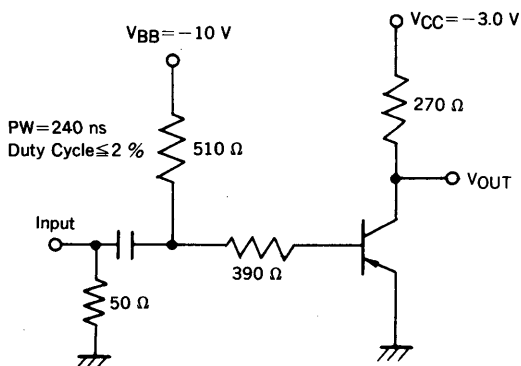

t_{stg} Switching

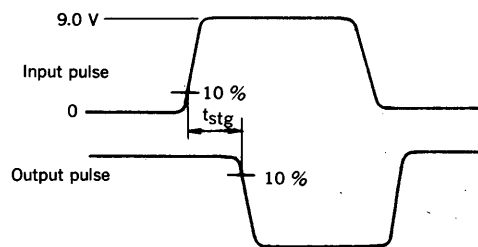

t_{stg} Voltage Waveforms

NEC Corporation

INTERNATIONAL ELECTRON DEVICES DIV.
SUMITOMO MITA Building, 37-8,
Shiba Gochome, Minato-ku, Tokyo 108, Japan
Tel: Tokyo 456-3111
Telex Address: NECTOK J22686
Cable Address: NEC TOKYO

TC-1638
JULY-10-85M
Printed in Japan