



2SA1416/2SC3646

High-Voltage Switching Applications

Features

- Adoption of FBET, MBIT processes.
- High breakdown voltage and large current capacity.
- Fast switching time.
- Very small size making it easy to provide high-density, small-sized hybrid ICs.

Package Dimensions

unit:mm

2038

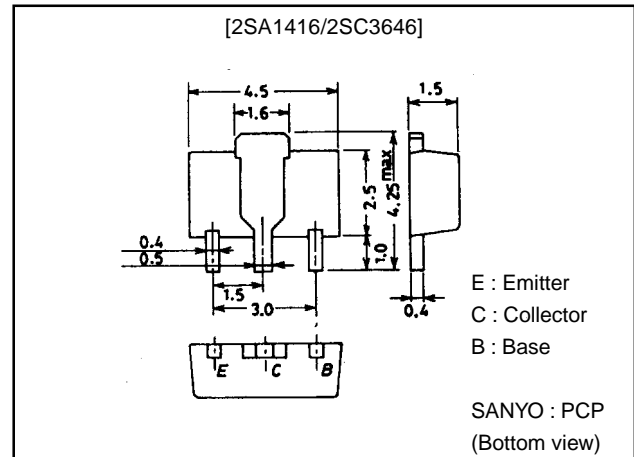

() : 2SA1416

Specifications

Absolute Maximum Ratings at $T_a = 25^\circ\text{C}$

Parameter	Symbol	Conditions	Ratings	Unit
Collector-to-Base Voltage	V_{CB0}		(-120)	V
Collector-to-Emitter Voltage	V_{CEO}		(-100)	V
Emitter-to-Base Voltage	V_{EBO}		(-6)	V
Collector Current	I_C		(-1)	A
Collector Current (Pulse)	I_{CP}		(-2)	A
Collector Dissipation	P_C		500	mW
		Mounted on ceramic board (250mm ² ×0.8mm)	1.3	W
Junction Temperature	T_j		150	°C
Storage Temperature	T_{stg}		-55 to +150	°C

Electrical Characteristics at $T_a = 25^\circ\text{C}$

Parameter	Symbol	Conditions	Ratings			Unit
			min	typ	max	
Collector Cutoff Current	I_{CBO}	$V_{CB}=(-)100\text{V}, I_E=0$			(-100)	nA
Emitter Cutoff Current	I_{EBO}	$V_{EB}=(-)4\text{V}, I_C=0$			(-100)	nA
DC Current Gain	h_{FE}	$V_{CE}=(-)5\text{V}, I_C=(-)100\text{mA}$	100*		400*	
Gain-Bandwidth Product	f_T	$V_{CE}=(-)10\text{V}, I_C=(-)100\text{mA}$		120		MHz
Output Capacitance	C_{ob}	$V_{CB}=(-)10\text{V}, f=1\text{MHz}$		(13)		pF
				8.5		pF
Collector-to-Emitter Saturation Voltage	$V_{CE(sat)}$	$I_C=(-)400\text{mA}, I_B=(-)40\text{mA}$		(-0.2)	(-0.6)	V
				0.1	0.4	V
Base-to-Emitter Saturation Voltage	$V_{BE(sat)}$	$I_C=(-)400\text{mA}, I_B=(-)40\text{mA}$		(-0.85)	(-1.2)	V
Collector-to-Base Breakdown Voltage	$V_{(BR)CBO}$	$I_C=(-)10\mu\text{A}, I_E=0$	(-120)			V
Collector-to-Emitter Breakdown Voltage	$V_{(BR)CEO}$	$I_C=(-)1\text{mA}, R_{BE}=\infty$	(-100)			V
Emitter-to-Base Breakdown Voltage	$V_{(BR)EBO}$	$I_E=(-)10\mu\text{A}, I_C=0$	(-6)			V
Turn-ON Time	t_{on}	See specified Test Circuit.		(80)		ns
				80		ns
Storage Time	t_{stg}	See specified Test Circuit.		(700)		ns
				850		ns
Fall Time	t_f	See specified Test Circuit.		(40)		ns
				50		ns

SANYO Electric Co., Ltd. Semiconductor Business Headquarters

TOKYO OFFICE Tokyo Bldg., 1-10, 1 Chome, Ueno, Taito-ku, TOKYO, 110-8534 JAPAN

2SA1416/2SC3646

* : The 2SA1416/2SC3646 are classified by 100mA h_{FE} as follows :

100	R	200	140	S	280	200	T	400
-----	---	-----	-----	---	-----	-----	---	-----

Marking 2SA1416 : AB h_{FE} rank : R, S, T
 2SC3646 : CB

Switching Time Test Circuit

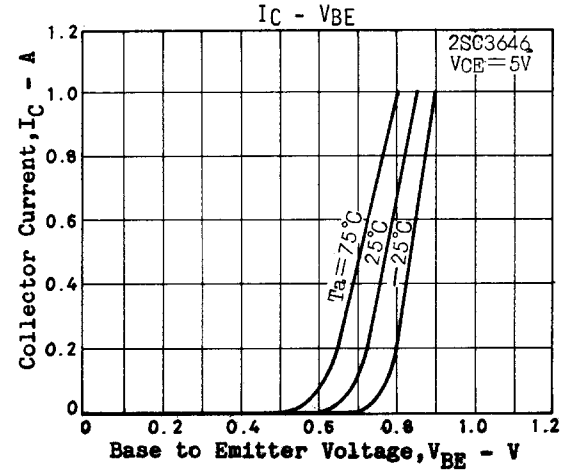
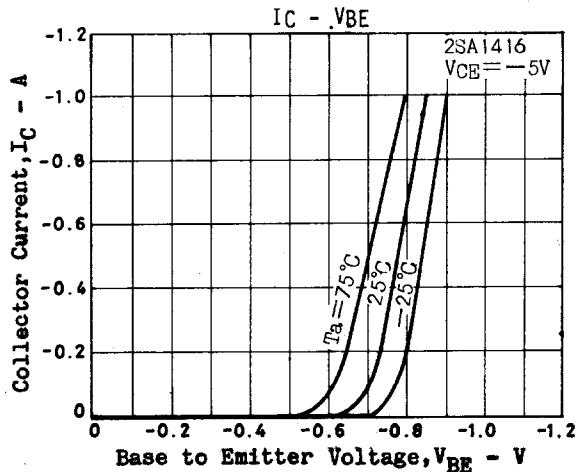
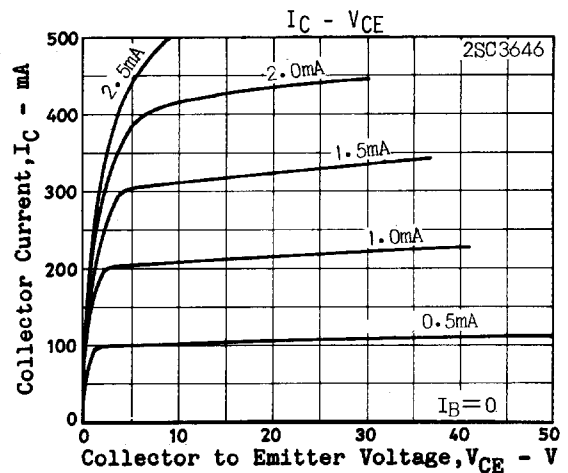
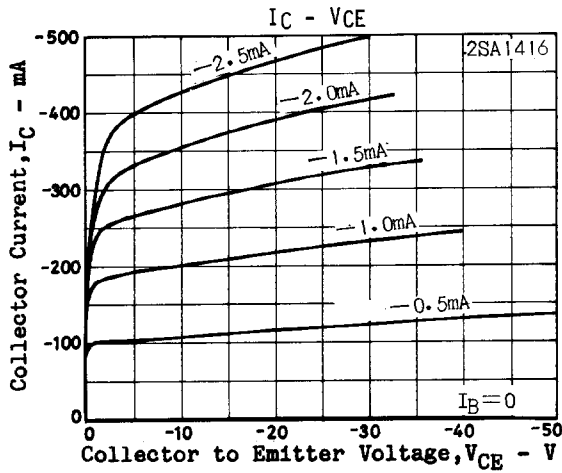
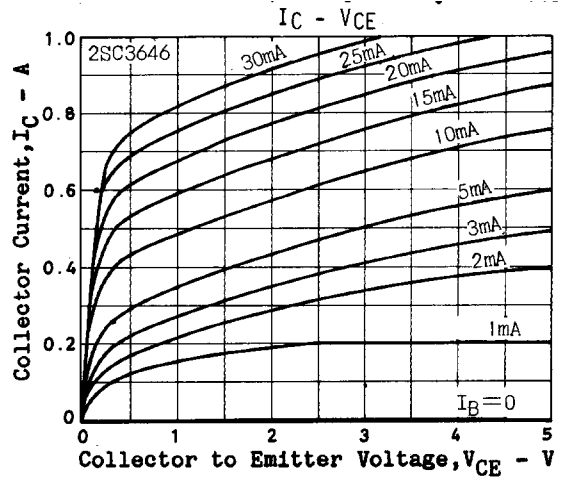
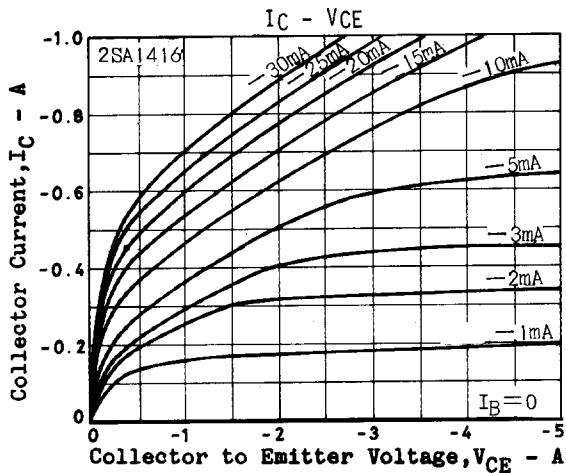
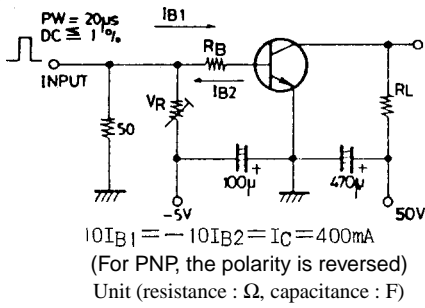

2SA1416/2SC3646

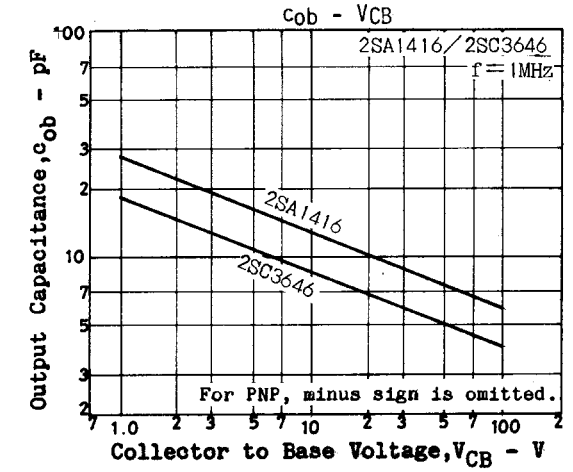
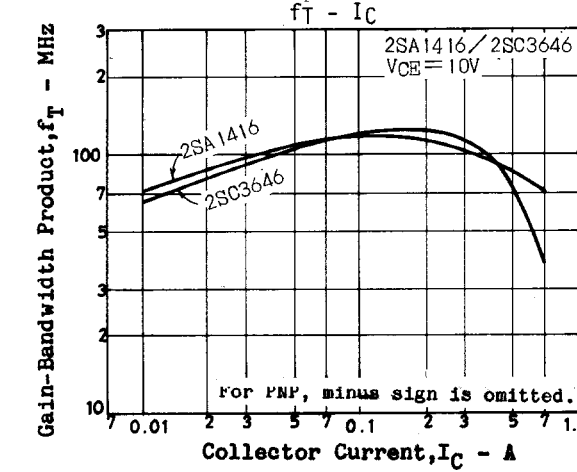
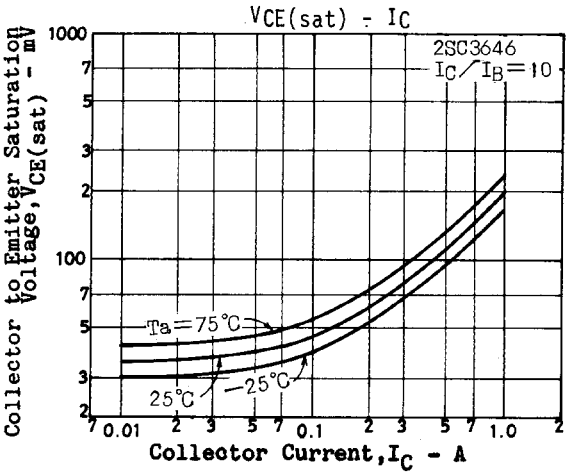
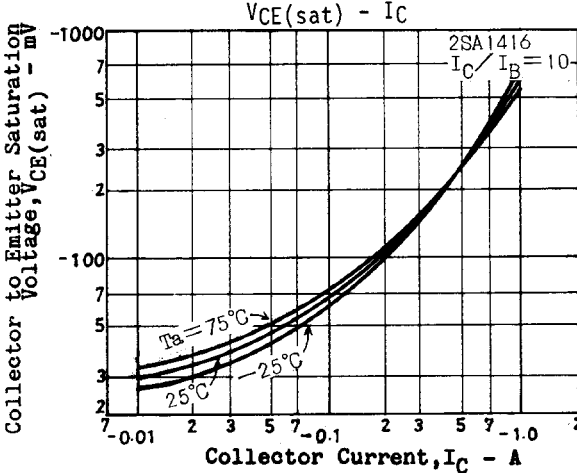
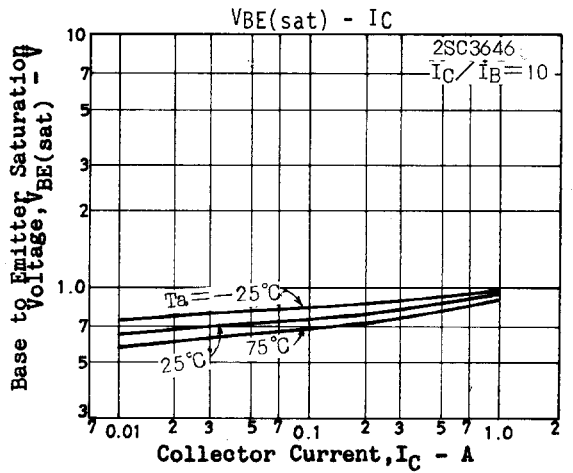
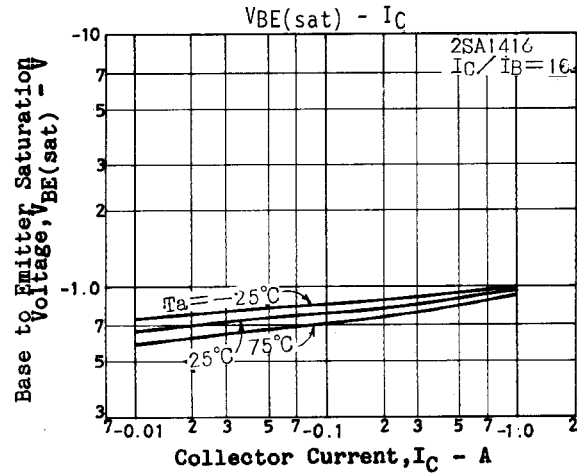
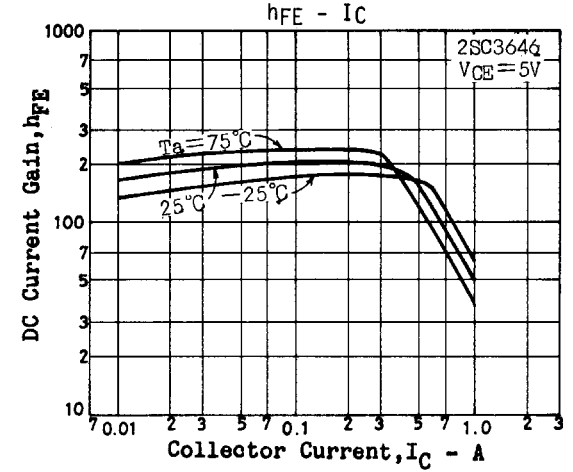
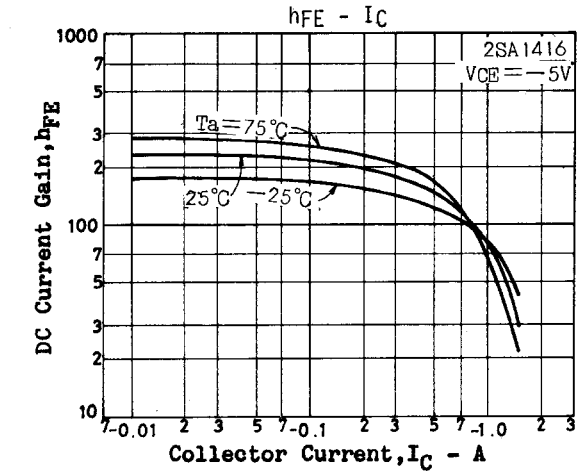

2SA1416/2SC3646

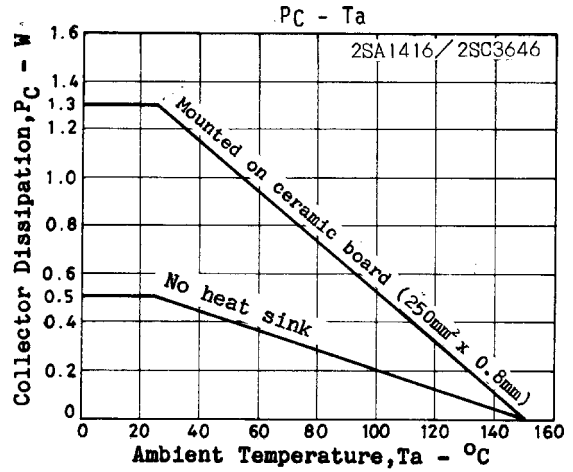
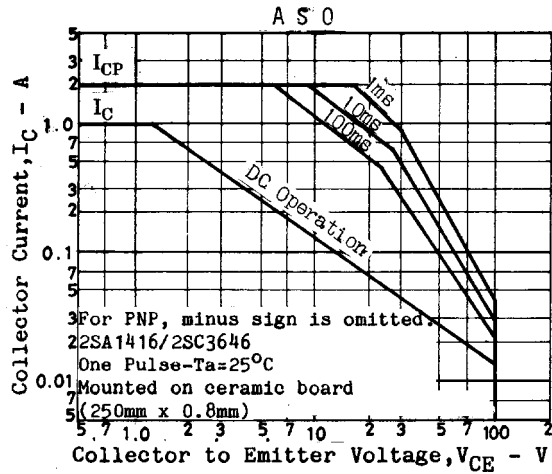

■ No products described or contained herein are intended for use in surgical implants, life-support systems, aerospace equipment, nuclear power control systems, vehicles, disaster/crime-prevention equipment and the like, the failure of which may directly or indirectly cause injury, death or property loss.

■ Anyone purchasing any products described or contained herein for an above-mentioned use shall:

- ① Accept full responsibility and indemnify and defend SANYO ELECTRIC CO., LTD., its affiliates, subsidiaries and distributors and all their officers and employees, jointly and severally, against any and all claims and litigation and all damages, cost and expenses associated with such use;
- ② Not impose any responsibility for any fault or negligence which may be cited in any such claim or litigation on SANYO ELECTRIC CO., LTD., its affiliates, subsidiaries and distributors or any of their officers and employees jointly or severally.

■ Information (including circuit diagrams and circuit parameters) herein is for example only; it is not guaranteed for volume production. SANYO believes information herein is accurate and reliable, but no guarantees are made or implied regarding its use or any infringements of intellectual property rights or other rights of third parties.

This catalog provides information as of July, 1998. Specifications and information herein are subject to change without notice.