

# MBT6429DW1T1

## Amplifier Transistors

### NPN Silicon

#### Features

- Pb-Free Package is Available

#### MAXIMUM RATINGS

Rating	Symbol	6429DW1T1	Unit
Collector-Emitter Voltage	$V_{CEO}$	45	Vdc
Collector-Base Voltage	$V_{CBO}$	55	Vdc
Emitter-Base Voltage	$V_{EBO}$	6.0	Vdc
Collector Current - Continuous	$I_C$	200	mAdc

#### THERMAL CHARACTERISTICS

Characteristic	Symbol	Max	Unit
Total Device Dissipation (Note 1) $T_A = 25^\circ\text{C}$	$P_D$	150	mW
Thermal Resistance, Junction to Ambient	$R_{\theta JA}$	833	$^\circ\text{C}/\text{W}$
Junction and Storage Temperature	$T_J, T_{stg}$	-55 to +150	$^\circ\text{C}$

- Device mounted on FR4 glass epoxy printed circuit board using the minimum recommended foot print.



**ON Semiconductor®**

<http://onsemi.com>

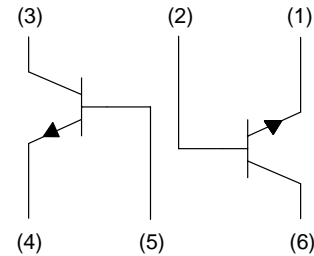

#### MARKING DIAGRAM

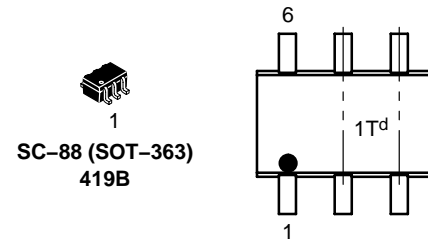

1T = Specific Device Code  
d = Date Code

#### ORDERING INFORMATION

Device	Package	Shipping†
MBT6429DW1T1	SC-88	3000 / Tape & Reel
MBT6429DW1T1G	SC-88 (Pb-Free)	3000 / Tape & Reel

†For information on tape and reel specifications, including part orientation and tape sizes, please refer to our Tape and Reel Packaging Specifications Brochure, BRD8011/D.

# MBT6429DW1T1

## ELECTRICAL CHARACTERISTICS ( $T_A = 25^\circ\text{C}$ unless otherwise noted)

Characteristic	Symbol	Min	Max	Unit
<b>OFF CHARACTERISTICS</b>				
Collector – Emitter Breakdown Voltage ( $I_C = 1.0 \text{ mAdc}, I_B = 0$ )	$V_{(BR)CEO}$	45	–	Vdc
Collector – Base Breakdown Voltage ( $I_C = 0.1 \text{ mAdc}, I_E = 0$ )	$V_{(BR)CBO}$	55	–	Vdc
Collector Cutoff Current ( $V_{CE} = 30 \text{ Vdc}$ )	$I_{CES}$	–	0.1	$\mu\text{Adc}$
Collector Cutoff Current ( $V_{CB} = 30 \text{ Vdc}, I_E = 0$ )	$I_{CBO}$	–	0.01	$\mu\text{Adc}$
Emitter Cutoff Current ( $V_{EB} = 5.0 \text{ Vdc}, I_C = 0$ )	$I_{EBO}$	–	0.01	$\mu\text{Adc}$
<b>ON CHARACTERISTICS</b>				
DC Current Gain ( $I_C = 0.01 \text{ mAdc}, V_{CE} = 5.0 \text{ Vdc}$ ) ( $I_C = 0.1 \text{ mAdc}, V_{CE} = 5.0 \text{ Vdc}$ ) ( $I_C = 1.0 \text{ mAdc}, V_{CE} = 5.0 \text{ Vdc}$ ) ( $I_C = 10 \text{ mAdc}, V_{CE} = 5.0 \text{ Vdc}$ )	$h_{FE}$	500 500 500 500	– 1250 – –	–
Collector – Emitter Saturation Voltage ( $I_C = 10 \text{ mAdc}, I_B = 0.5 \text{ mAdc}$ ) ( $I_C = 100 \text{ mAdc}, I_B = 5.0 \text{ mAdc}$ )	$V_{CE(sat)}$	– –	0.2 0.6	Vdc
Base – Emitter On Voltage ( $I_C = 1.0 \text{ mAdc}, V_{CE} = 5.0 \text{ Vdc}$ )	$V_{BE(on)}$	0.56	0.66	Vdc
<b>SMALL-SIGNAL CHARACTERISTICS</b>				
Current – Gain – Bandwidth Product ( $I_C = 1.0 \text{ mAdc}, V_{CE} = 5.0 \text{ Vdc}, f = 100 \text{ MHz}$ )	$f_T$	100	700	MHz
Output Capacitance ( $V_{CB} = 10 \text{ Vdc}, I_E = 0, f = 1.0 \text{ MHz}$ )	$C_{obo}$	–	3.0	pF
Input Capacitance ( $V_{EB} = 0.5 \text{ Vdc}, I_C = 0, f = 1.0 \text{ MHz}$ )	$C_{ibo}$	–	8.0	pF

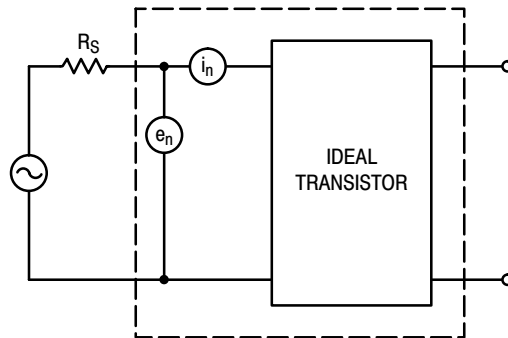

**Figure 1. Transistor Noise Model**

# MBT6429DW1T1

## NOISE CHARACTERISTICS

( $V_{CE} = 5.0 \text{ Vdc}$ ,  $T_A = 25^\circ\text{C}$ )

### NOISE VOLTAGE

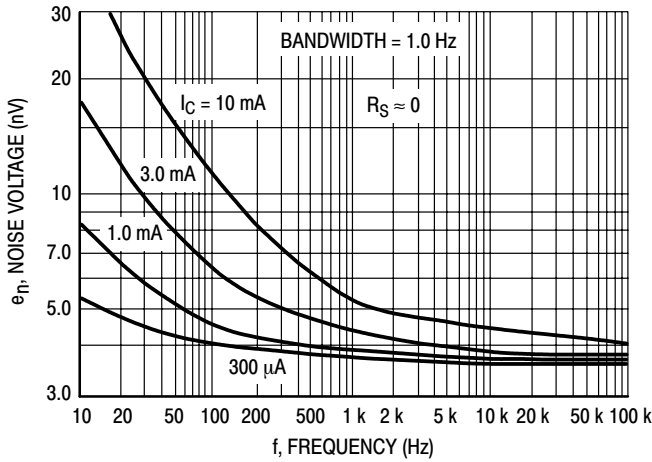

Figure 2. Effects of Frequency

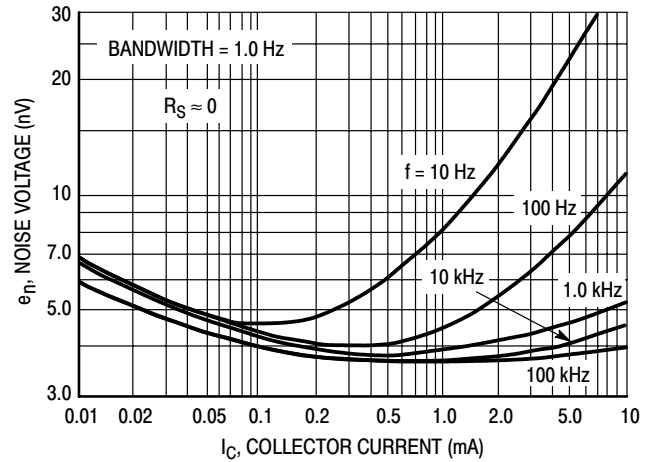

Figure 3. Effects of Collector Current

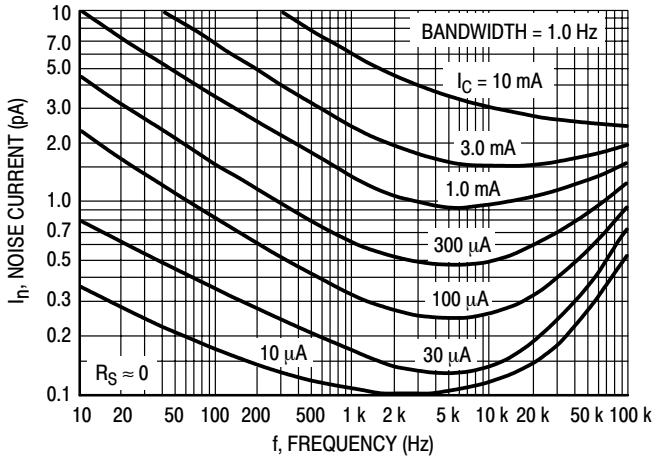

Figure 4. Noise Current

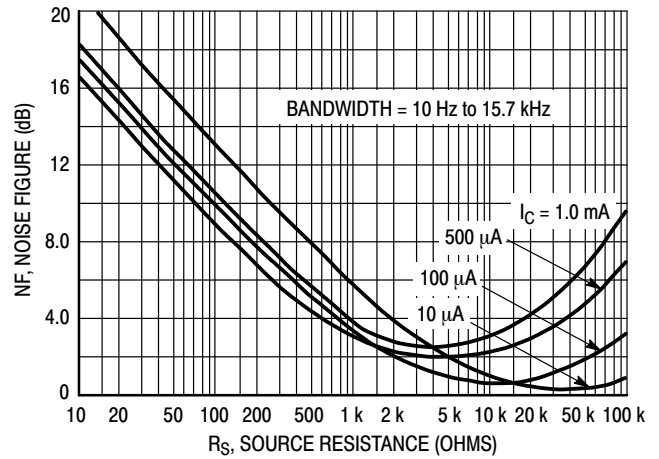

Figure 5. Wideband Noise Figure

### 100 Hz NOISE DATA

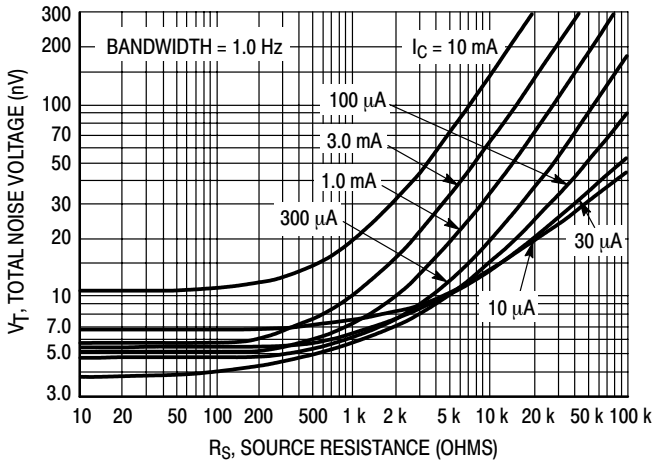

Figure 6. Total Noise Voltage

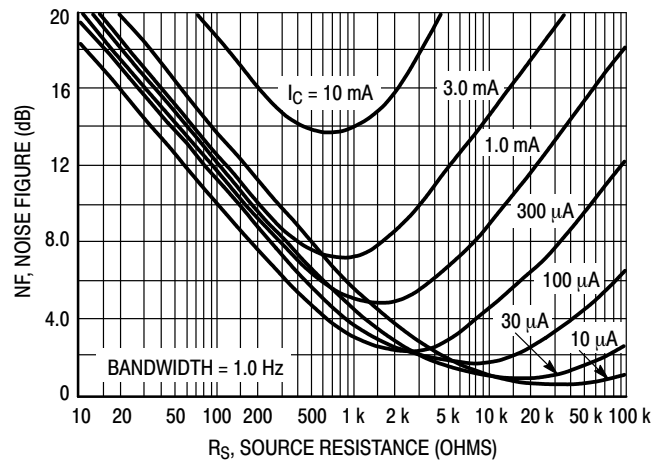

Figure 7. Noise Figure

# MBT6429DW1T1

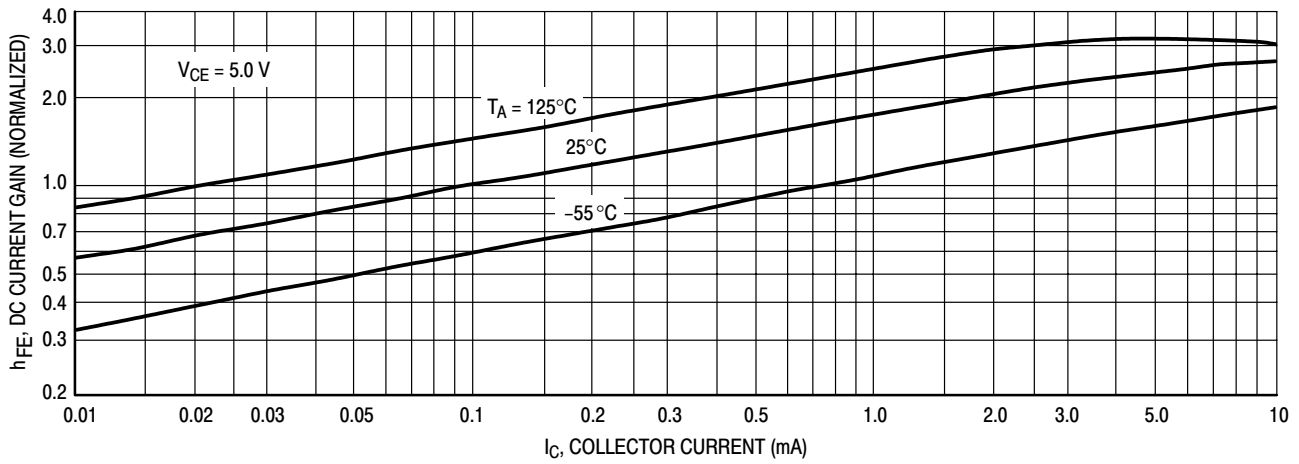

Figure 8. DC Current Gain

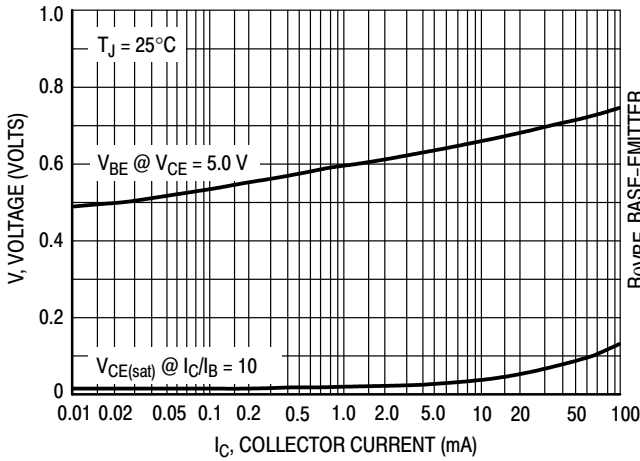

Figure 9. "On" Voltages

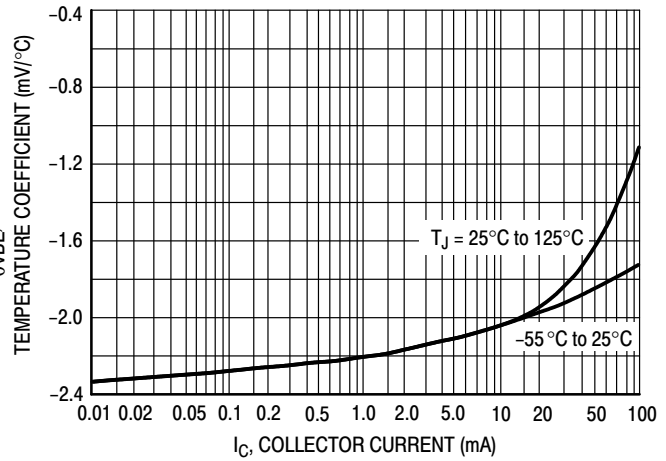

Figure 10. Temperature Coefficients

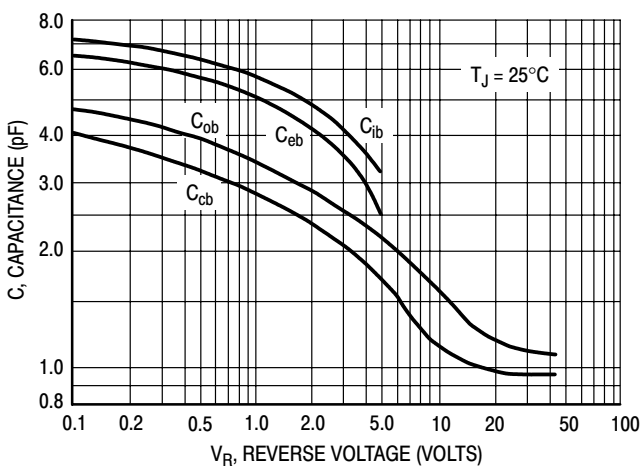

Figure 11. Capacitance

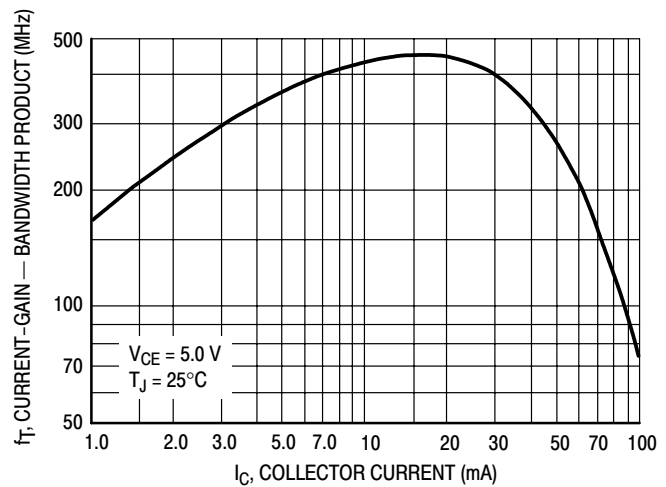

Figure 12. Current-Gain - Bandwidth Product

# MBT6429DW1T1

## PACKAGE DIMENSIONS

SC-88/SC70-6/SOT-363  
CASE 419B-02  
ISSUE 02U

- NOTES:  
1. DIMENSIONING AND TOLERANCING PER ANSI Y14.5M, 1982.  
2. CONTROLLING DIMENSION: INCH.  
3. 419B-01 OBSOLETE, NEW STANDARD 419B-02.

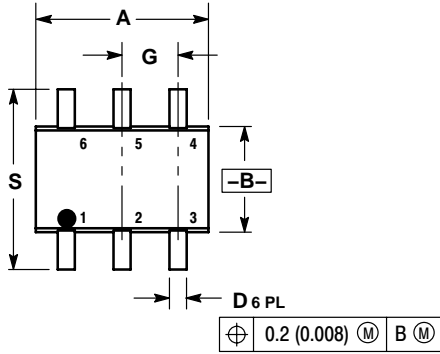

DIM	INCHES		MILLIMETERS	
	MIN	MAX	MIN	MAX
A	0.071	0.087	1.80	2.20
B	0.045	0.053	1.15	1.35
C	0.031	0.043	0.80	1.10
D	0.004	0.012	0.10	0.30
G	0.026 BSC		0.65 BSC	
H	---	0.004	---	0.10
J	0.004	0.010	0.10	0.25
K	0.004	0.012	0.10	0.30
N	0.008 REF		0.20 REF	
S	0.079	0.087	2.00	2.20

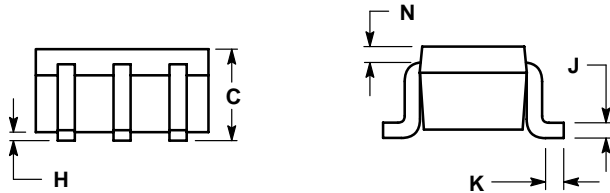

### SOLDERING FOOTPRINT\*

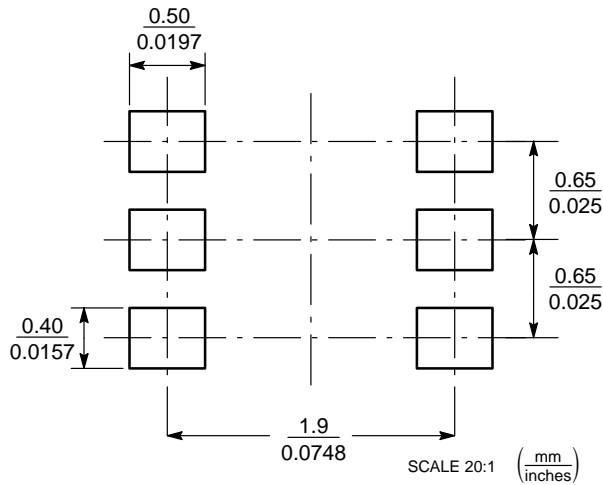

### SC-88/SC70-6/SOT-363

\*For additional information on our Pb-Free strategy and soldering details, please download the ON Semiconductor Soldering and Mounting Techniques Reference Manual, SOLDERRM/D.

**ON Semiconductor** and  are registered trademarks of Semiconductor Components Industries, LLC (SCILLC). SCILLC reserves the right to make changes without further notice to any products herein. SCILLC makes no warranty, representation or guarantee regarding the suitability of its products for any particular purpose, nor does SCILLC assume any liability arising out of the application or use of any product or circuit, and specifically disclaims any and all liability, including without limitation special, consequential or incidental damages. "Typical" parameters which may be provided in SCILLC data sheets and/or specifications can and do vary in different applications and actual performance may vary over time. All operating parameters, including "Typicals" must be validated for each customer application by customer's technical experts. SCILLC does not convey any license under its patent rights nor the rights of others. SCILLC products are not designed, intended, or authorized for use as components in systems intended for surgical implant into the body, or other applications intended to support or sustain life, or for any other application in which the failure of the SCILLC product could create a situation where personal injury or death may occur. Should Buyer purchase or use SCILLC products for any such unintended or unauthorized application, Buyer shall indemnify and hold SCILLC and its officers, employees, subsidiaries, affiliates, and distributors harmless against all claims, costs, damages, and expenses, and reasonable attorney fees arising out of, directly or indirectly, any claim of personal injury or death associated with such unintended or unauthorized use, even if such claim alleges that SCILLC was negligent regarding the design or manufacture of the part. SCILLC is an Equal Opportunity/Affirmative Action Employer. This literature is subject to all applicable copyright laws and is not for resale in any manner.

## PUBLICATION ORDERING INFORMATION

### LITERATURE FULFILLMENT:

Literature Distribution Center for ON Semiconductor  
P.O. Box 5163, Denver, Colorado 80217 USA

**Phone:** 303-675-2175 or 800-344-3860 Toll Free USA/Canada

**Fax:** 303-675-2176 or 800-344-3867 Toll Free USA/Canada

**Email:** [orderlit@onsemi.com](mailto:orderlit@onsemi.com)

**N. American Technical Support:** 800-282-9855 Toll Free  
USA/Canada

**Japan:** ON Semiconductor, Japan Customer Focus Center  
2-9-1 Kamimeguro, Meguro-ku, Tokyo, Japan 153-0051  
**Phone:** 81-3-5773-3850

**ON Semiconductor Website:** <http://onsemi.com>

**Order Literature:** <http://www.onsemi.com/litorder>

For additional information, please contact your  
local Sales Representative.