



## N-Channel JFETs

J111 SST111  
J112 SST112  
J113 SST113

PRODUCT SUMMARY				
Part Number	V <sub>GS(off)</sub> (V)	r <sub>DS(on)</sub> Max (Ω)	I <sub>D(off)</sub> Typ (pA)	t <sub>ON</sub> Typ (ns)
J/SST111	-3 to -10	30	5	4
J/SST112	-1 to -5	50	5	4
J/SST113	≤ -3	100	5	4

### FEATURES

- Low On-Resistance: 111 < 30 Ω
- Fast Switching—t<sub>ON</sub>: 4 ns
- Low Leakage: 5 pA
- Low Capacitance: 3 pF
- Low Insertion Loss

### BENEFITS

- Low Error Voltage
- High-Speed Analog Circuit Performance
- Negligible “Off-Error,” Excellent Accuracy
- Good Frequency Response, Low Glitches
- Eliminates Additional Buffering

### APPLICATIONS

- Analog Switches
- Choppers
- Sample-and-Hold
- Normally “On” Switches
- Current Limiters

### DESCRIPTION

The J/SST111 series consists of all-purpose analog switches designed to support a wide range of applications. The J/SST113 are useful in a high-gain amplifier mode.

For similar products in TO-206AA(TO-18) packaging, see the 2N/PN/SST4391 series, 2N4856A/4857A/4858A, and 2N5564/5565/5566 (duals) data sheets.

The J series, TO-226AA (TO-92) plastic package, provides low cost, while the SST series, TO236 (SOT-23) package, provides surface-mount capability. Both the J and SST series are available in tape-and-reel for automated assembly (see Packaging Information).

TO-226AA (TO-92)

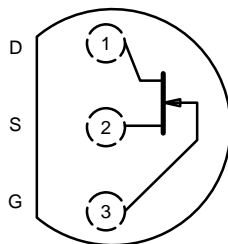

Top View

J111  
J112  
J113

TO-236 (SOT-23)

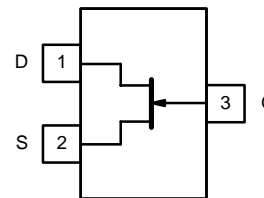

Top View

SST111 (C1)\*  
SST112 (C2)\*  
SST113 (C3)\*

\*Marking Code for TO-236

### ABSOLUTE MAXIMUM RATINGS

Gate-Drain, Gate-Source Voltage	-35 V
Gate Current	50 mA
Lead Temperature (1/16" from case for 10 seconds)	300 °C
Storage Temperature	-55 to 150 °C
Operating Junction Temperature	-55 to 150 °C

Power Dissipation <sup>a</sup>	
(TO-236)	350 mW
(TO-226AA)	360 mW

Notes  
a. Derate 2.8 mW/°C above 25 °C

For applications information see AN105.



SPECIFICATIONS (T <sub>A</sub> = 25 °C UNLESS OTHERWISE NOTED)										
Parameter	Symbol	Test Conditions	Typ <sup>a</sup>	Limits						Unit
				J/SST111		J/SST112		J/SST113		
				Min	Max	Min	Max	Min	Max	
<b>Static</b>										
Gate-Source Breakdown Voltage	V <sub>(BR)GSS</sub>	I <sub>G</sub> = -1 μA, V <sub>DS</sub> = 0 V	-55	-35		-35		-35		V
Gate-Source Cutoff Voltage	V <sub>GS(off)</sub>	V <sub>DS</sub> = 5 V, I <sub>D</sub> = 1 μA		-3	-10	-1	-5		-3	
Saturation Drain Current <sup>b</sup>	I <sub>DSS</sub>	V <sub>DS</sub> = 15 V, V <sub>GS</sub> = 0 V		20		5		2		mA
Gate Reverse Current	I <sub>GSS</sub>	V <sub>GS</sub> = -15 V, V <sub>DS</sub> = 0 V	-0.005		-1		-1		-1	nA
		T <sub>A</sub> = 125 °C	-3							
Gate Operating Current	I <sub>G</sub>	V <sub>DG</sub> = 15 V, I <sub>D</sub> = 10 mA	-5							pA
Drain Cutoff Current	I <sub>D(off)</sub>	V <sub>DS</sub> = 5 V, V <sub>GS</sub> = -10 V	0.005		1		1		1	nA
		T <sub>A</sub> = 125 °C	3							
Drain-Source On-Resistance	r <sub>DS(on)</sub>	V <sub>GS</sub> = 0 V, V <sub>DS</sub> = 0.1 V			30		50		100	Ω
Gate-Source Forward Voltage	V <sub>GS(F)</sub>	I <sub>G</sub> = 1 mA, V <sub>DS</sub> = 0 V	0.7							V
<b>Dynamic</b>										
Common-Source Forward Transconductance	g <sub>fs</sub>	V <sub>DS</sub> = 20 V, I <sub>D</sub> = 1 mA f = 1 kHz	6							mS
Common-Source Output Conductance	g <sub>os</sub>		25							μS
Drain-Source On-Resistance	r <sub>ds(on)</sub>	V <sub>GS</sub> = 0 V, I <sub>D</sub> = 0 mA f = 1 kHz			30		50		100	Ω
Common-Source Input Capacitance	C <sub>iss</sub>	V <sub>DS</sub> = 0 V, V <sub>GS</sub> = -10 V f = 1 MHz	7		12		12		12	pF
Common-Source Reverse Transfer Capacitance	C <sub>rss</sub>		3		5		5		5	
Equivalent Input Noise Voltage	e <sub>n</sub>	V <sub>DG</sub> = 10 V, I <sub>D</sub> = 1 mA f = 1 kHz	3							nV/ √Hz
<b>Switching</b>										
Turn-On Time	t <sub>d(on)</sub>	V <sub>DD</sub> = 10 V, V <sub>GS(H)</sub> = 0 V See Switching Circuit	2							ns
	t <sub>r</sub>		2							
Turn-Off Time	t <sub>d(off)</sub>		6							
	t <sub>f</sub>		15							

**Notes**

a. Typical values are for DESIGN AID ONLY, not guaranteed nor subject to production testing.

b. Pulse test: PW ≤ 300 μs duty cycle ≤ 3%.

NCB



**TYPICAL CHARACTERISTICS (T<sub>A</sub> = 25°C UNLESS OTHERWISE NOTED)**

**On-Resistance and Drain Current vs. Gate-Source Cutoff Voltage**

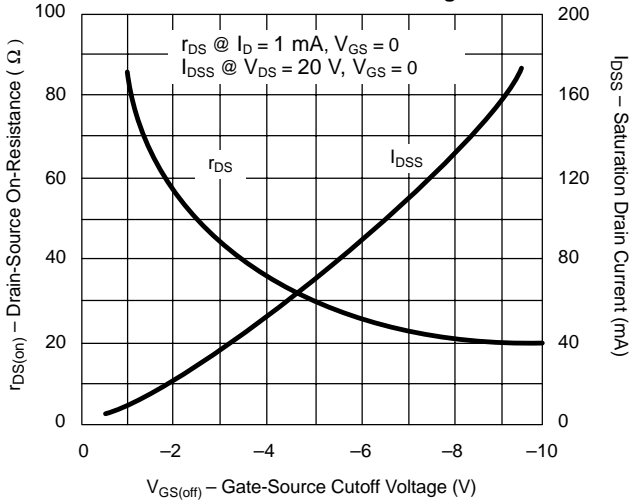

**On-Resistance vs. Drain Current**

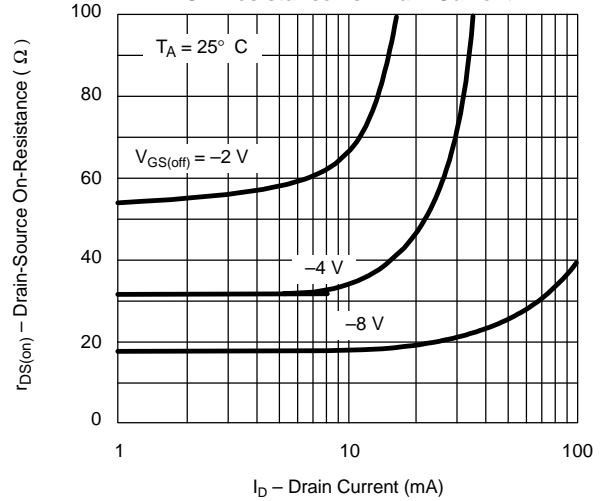

**On-Resistance vs. Temperature**

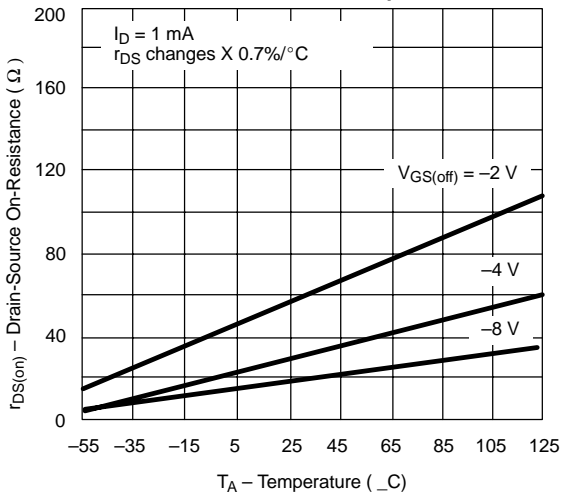

**Turn-On Switching**

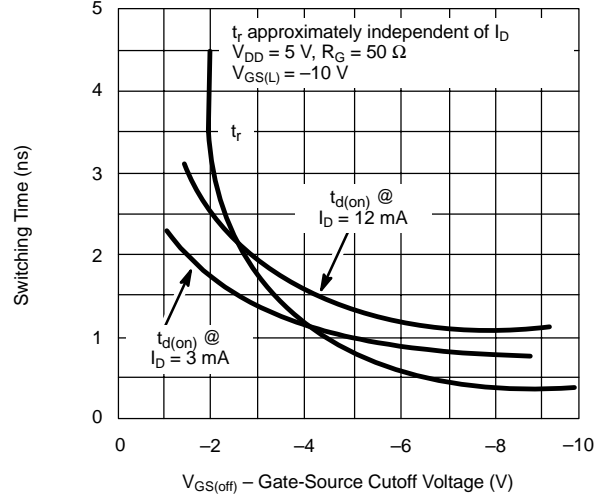

**Turn-Off Switching**

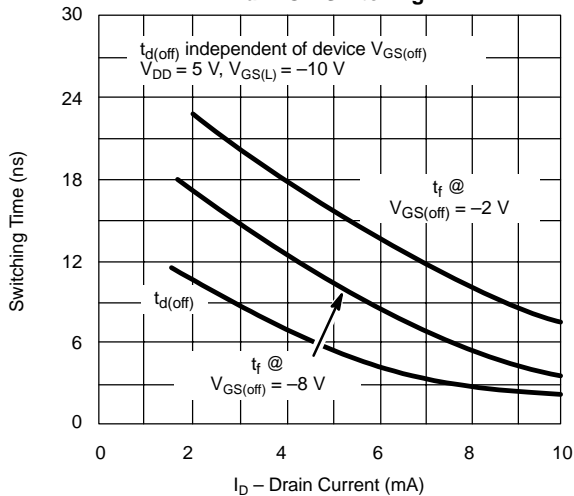

**Capacitance vs. Gate-Source Voltage**

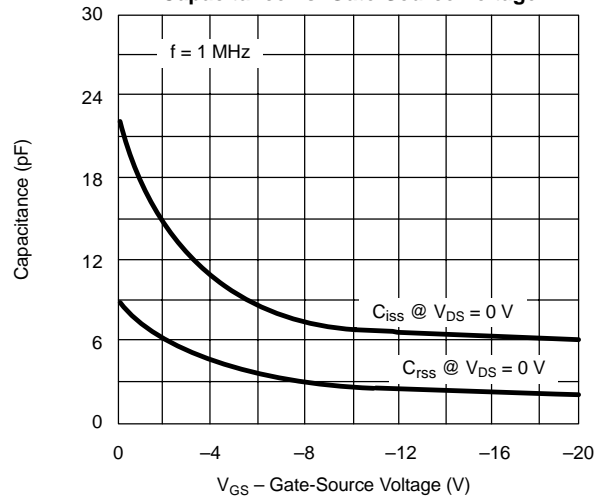



### TYPICAL CHARACTERISTICS ( $T_A = 25^\circ\text{C}$ UNLESS OTHERWISE NOTED)

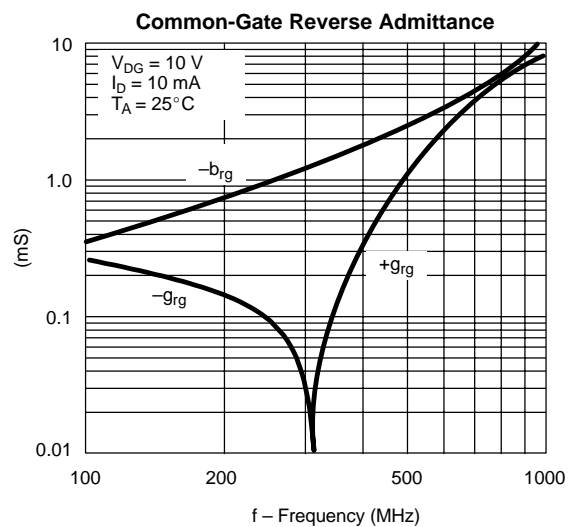
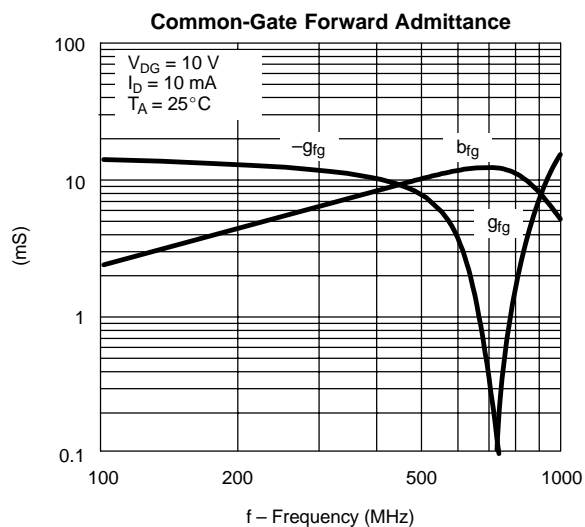
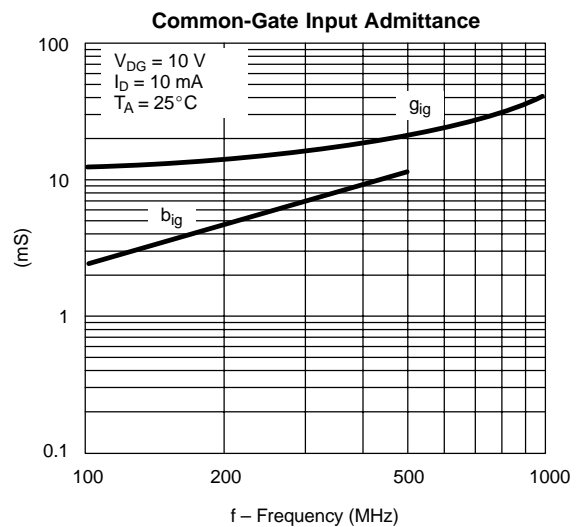
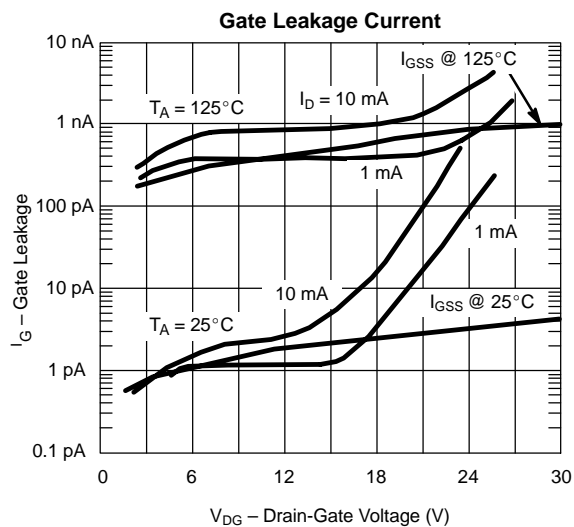
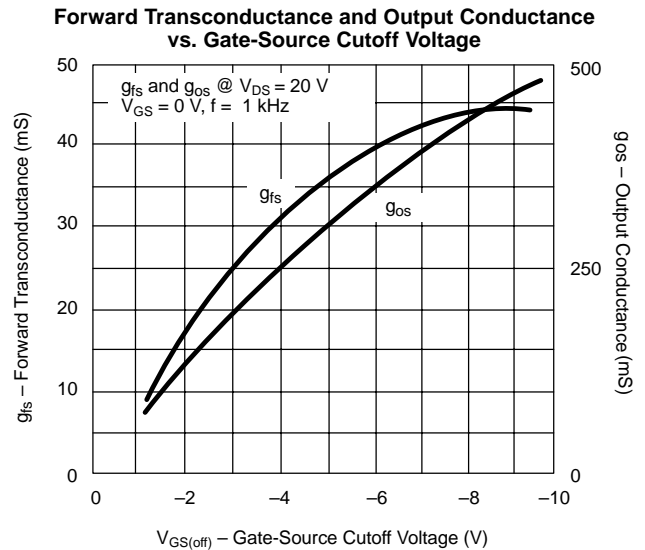
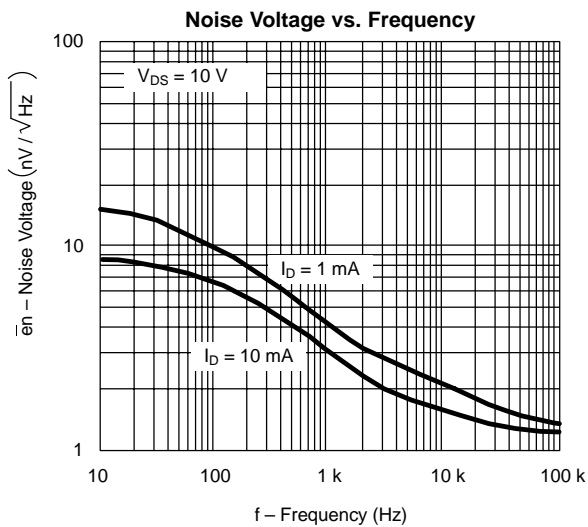



**TYPICAL CHARACTERISTICS ( $T_A = 25^\circ\text{C}$  UNLESS OTHERWISE NOTED)**

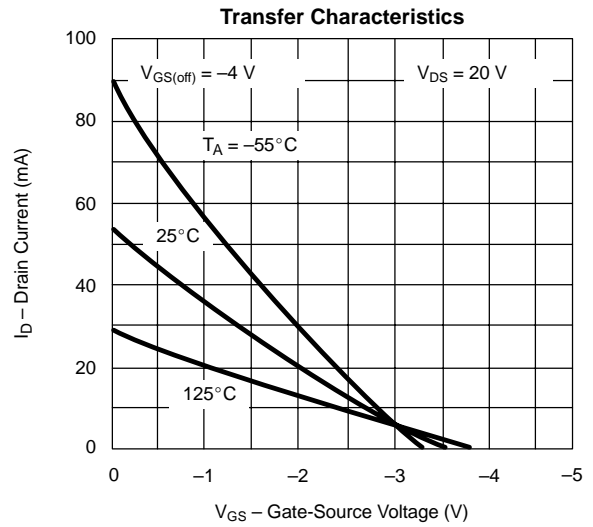
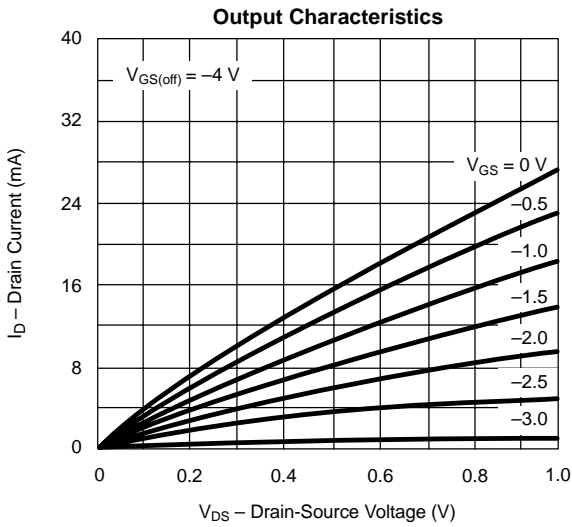
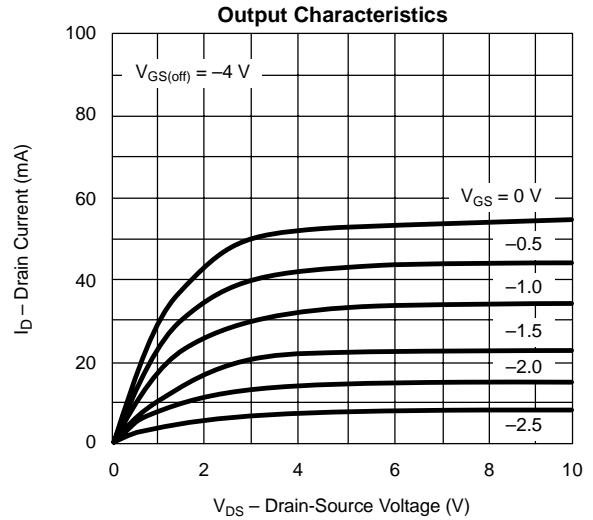
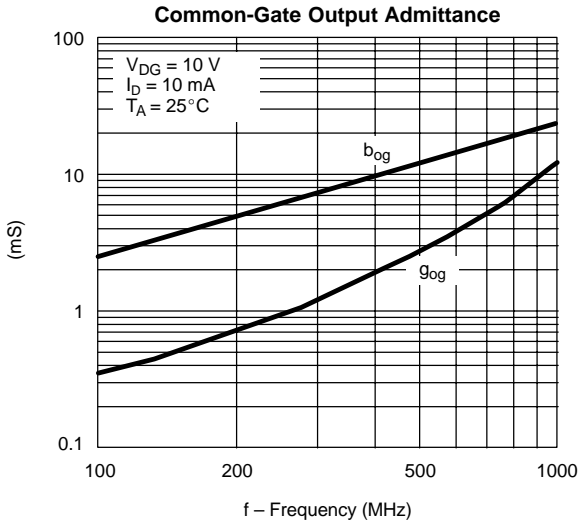

<b>SWITCHING TIME TEST CIRCUIT</b>			
	<b>J/SST111</b>	<b>J/SST112</b>	<b>J/SST113</b>
$V_{GS(L)}$	-12 V	-7 V	-5 V
$R_L^*$	800 $\Omega$	1600 $\Omega$	3200 $\Omega$
$I_{D(on)}$	12 mA	6 mA	3 mA

\*Non-inductive

**INPUT PULSE**

Rise Time < 1 ns  
Fall Time < 1 ns  
Pulse Width 100 ns  
PRF 1 MHz

**SAMPLING SCOPE**

Rise Time 0.4 ns  
Input Resistance 10 M $\Omega$   
Input Capacitance 1.5 pF

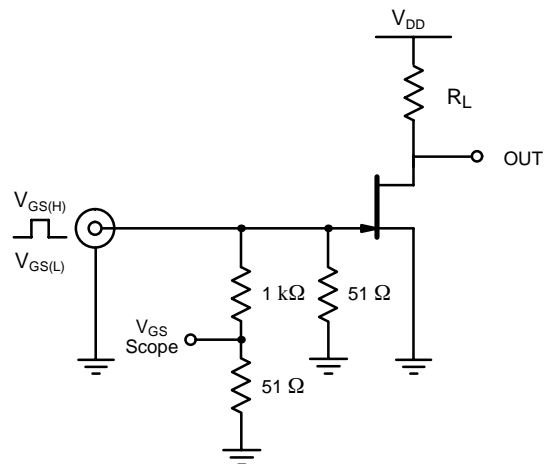

This datasheet has been download from:

[www.datasheetcatalog.com](http://www.datasheetcatalog.com)

Datasheets for electronics components.