

DG1S6

60V 1A

## 特長

- 超小型SMD
- 超薄型=0.8mm
- 低VF=0.58V

## Feature

- Ultra-small SMD
- Ultra-thin PKG=0.8mm
- Low VF=0.58V

## 用途

- スイッチング電源
- DC/DC コンバータ
- 家電、ゲーム、OA 機器
- 通信

## Main Use

- Switching Regulator
- DC/DC Converter
- Home Appliance, Game, Office Automation
- Communication

## ■外観図 OUTLINE

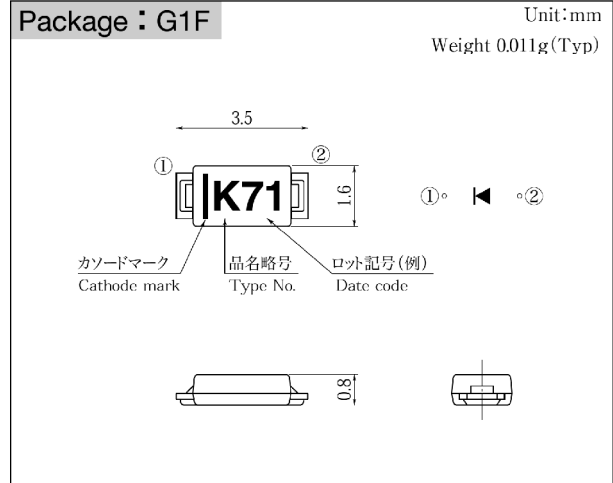

外形図については新電元Webサイト又は〈ダイオードカタログ・技術資料編〉を参照下さい。捺印表示については捺印仕様をご確認下さい。

For details of the outline dimensions, refer to our web site or the diode technical data book. As for the marking, refer to the specification "Marking, Terminal Connection".

## ■定格表 RATINGS

●絶対最大定格 Absolute Maximum Ratings (指定のない場合  $T_l = 25^\circ\text{C}$ )

項目 Item	記号 Symbol	条件 Conditions	品名 Type No.	DG1S6	単位 Unit
保存温度 Storage Temperature	Tstg			-55~150	℃
接合部温度 Operation Junction Temperature	Tj			150	℃
せん頭逆電圧 Maximum Reverse Voltage	V <sub>RM</sub>			60	V
出力電流 Average Rectified Forward Current	I <sub>o</sub>	50Hz正弦波, 抵抗負荷 50Hz sine wave, Resistance load	T <sub>a</sub> = 40℃ *1	0.5	A
			T <sub>a</sub> = 64℃ *2	0.7	
			T <sub>l</sub> = 128℃	1.0	
せん頭サージ順電流 Peak Surge Forward Current	I <sub>FSM</sub>	50Hz正弦波, 非繰り返し1サイクルせん頭値, T <sub>j</sub> = 25℃ 50Hz sine wave, Non-repetitive 1 cycle peak value, T <sub>j</sub> = 25℃		30	A

●電氣的・熱的特性 Electrical Characteristics (指定のない場合  $T_l = 25^\circ\text{C}$ )

項目 Item	記号 Symbol	条件 Conditions	品名 Type No.	DG1S6	単位 Unit
順電圧 Forward Voltage	V <sub>F</sub>	I <sub>F</sub> = 0.7A, パルス測定 Pulse measurement		MAX 0.58	V
逆電流 Reverse Current	I <sub>R</sub>	V <sub>R</sub> = V <sub>RM</sub> , パルス測定 Pulse measurement		MAX 1	mA
接合容量 Junction Capacitance	C <sub>j</sub>	f = 1MHz, V <sub>R</sub> = 10V		TYP 32	pF
熱抵抗 Thermal Resistance	θ <sub>ja</sub>	接合部・周囲間 Junction to ambient	*1	MAX 210	℃/W
			*2	MAX 120	
			*3	MAX 70	
	θ <sub>jl</sub>	接合部・リード間 Junction to lead	*3	MAX 20	

\*1 1インチプリント基板 (パターン32.6mm<sup>2</sup>)  
Measured on 1 x 1 inch substrate (pattern area : 32.6mm<sup>2</sup>)

\*2 1インチプリント基板 (パターン160mm<sup>2</sup>)  
Measured on 1 x 1 inch substrate (pattern area : 160mm<sup>2</sup>)

\*3 2インチアルミナ基板 (パターン2,100mm<sup>2</sup>)  
Measured on 2 x 2 inch alumina substrate (pattern area : 2,100mm<sup>2</sup>)

★記載内容は製品改良のためにお断りなしに変更することがあります。  
★All specifications are subject to change without notice.

■特性図 CHARACTERISTIC DIAGRAMS

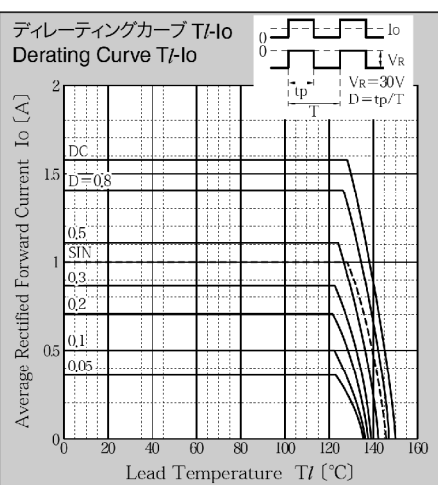
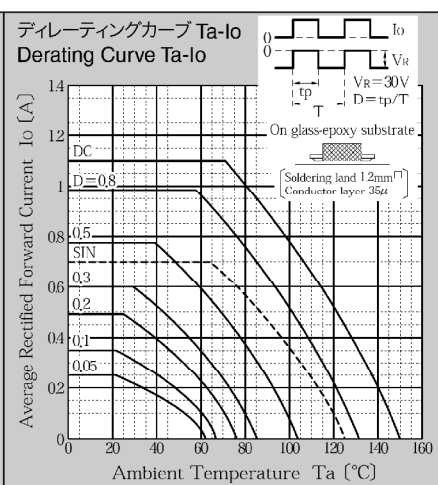
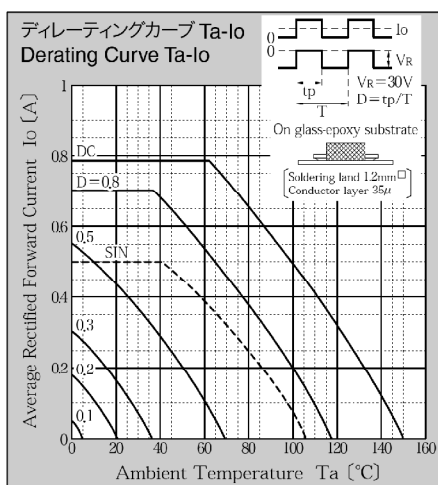
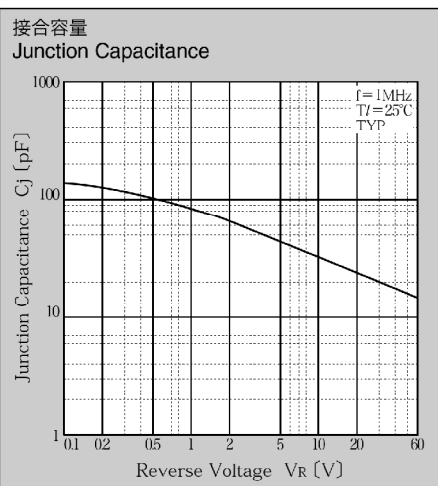
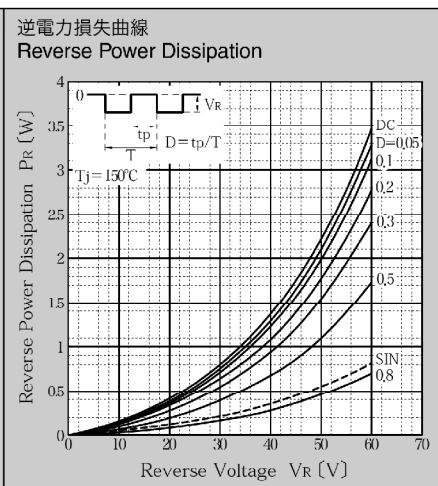
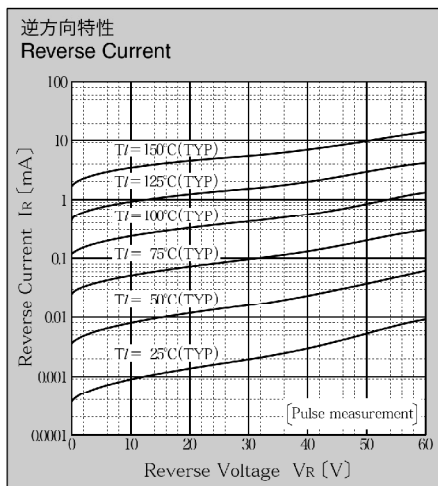
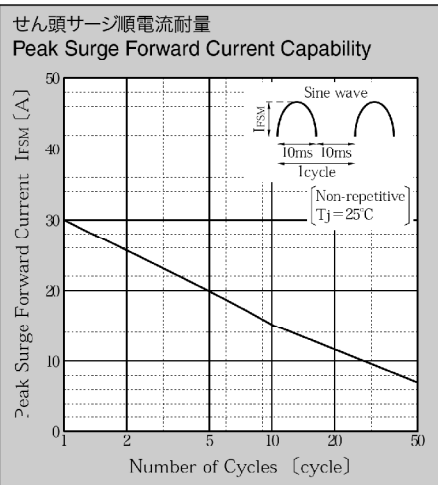
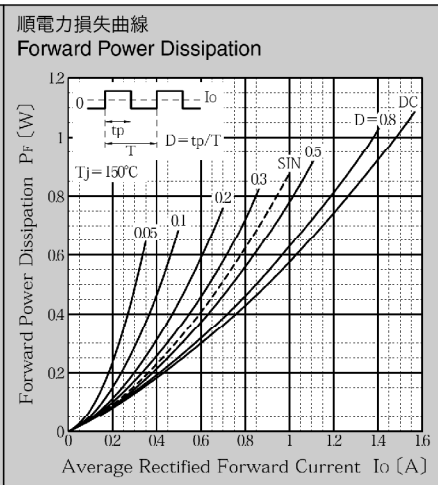
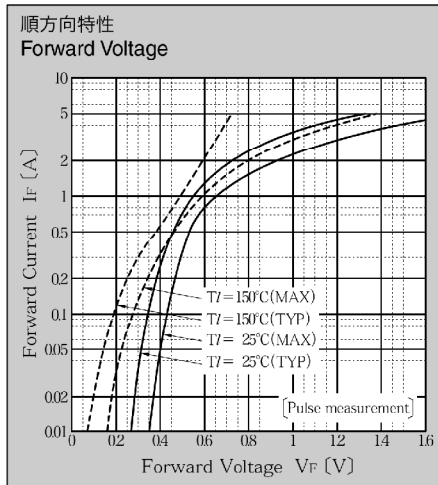

\*1インチプリント基板 (パターン32.6mm<sup>2</sup>)  
Measured on 1 x 1 inch substrate  
(pattern area 32.6mm<sup>2</sup>)

\*1インチプリント基板 (パターン160mm<sup>2</sup>)  
Measured on 1 x 1 inch substrate  
(pattern area 160mm<sup>2</sup>)

\* Sine waveは50Hzで測定しています。  
\* 50Hz sine wave is used for measurements.  
\* 半導体製品の特性は一般的にバラツキを持っております。  
Typicalは統計的な実力を表しています。  
\* Semiconductor products generally have characteristic variation.  
Typical is a statistical average of the device's ability.